

ECB-UNRESTRICTED

# AGREEMENT

OF *[DATE]*

ON THE PARTICIPATION OF

*[NCB]*

IN

TARGET2-SECURITIES

# Currency Participation Agreement

---

THIS AGREEMENT IS ENTERED INTO ON [DATE] BETWEEN:

**The European Central Bank**

Kaiserstraße 29

60311 Frankfurt am Main

Germany

and

**Nationale Bank van België/Banque Nationale de Belgique**

de Berlaimontlaan/Boulevard de Berlaimont 14

1000 Brussels

Belgium

**Deutsche Bundesbank**

Wilhelm-Epstein-Str. 14

60431 Frankfurt am Main

Germany

**Eesti Pank**

Estonia pst. 13

15095 Tallinn

Estonia

**Central Bank of Ireland**

PO Box 559

Dame Street

Dublin 2

Ireland

# Currency Participation Agreement

---

## **Bank of Greece**

21, E. Venizelos Avenue

P.O. Box 3105

102 50 Athens

Greece

## **Banco de España**

Alcalá 48

28014 Madrid

Spain

## **Banque de France**

31, rue Croix-des-Petits-Champs

75001 Paris

France

## **Banca d'Italia**

Via Nazionale, 91

00184 Rome

Italy

## **Central Bank of Cyprus**

80, Kennedy Avenue

1076 Nicosia

Cyprus

## **Banque centrale du Luxembourg**

2, boulevard Royal

2983 Luxembourg

Luxembourg

# Currency Participation Agreement

---

## **Central Bank of Malta**

Pjazza Kastilja

Valletta VLT 1060

Malta

## **De Nederlandsche Bank**

Westeinde 1

1017 ZN Amsterdam

Netherlands

## **Oesterreichische Nationalbank**

Otto-Wagner-Platz 3

1090 Vienna

Austria

## **Banco de Portugal**

Rua do Comercio, 27

1100-150 Lisbon

Portugal

## **Banka Slovenije**

Slovenska 35

1505 Ljubljana

Slovenia

## **Národná banka Slovenska**

Imricha Karvaša 1

813 25 Bratislava

Slovakia

# Currency Participation Agreement

---

**Suomen Pankki**

Snellmaninaukio

00170 Helsinki

Finland

(hereinafter collectively referred to as '**Eurosystem**' or '**Eurosystem Central Banks**')

and

**[NCB]**

*[address]*

The parties to this Agreement are referred to collectively as the '**Parties**' or individually as a '**Party**'.

# Currency Participation Agreement

---

## TABLE OF CONTENTS

<b>LIST OF SCHEDULES.....</b>	<b>1</b>
<b>PREAMBLE.....</b>	<b>2</b>
<b>CHAPTER 1 SCOPE, DEFINITIONS AND INTERPRETATION OF THE AGREEMENT .....</b>	<b>4</b>
Article 1 Subject matter and scope.....	4
Article 2 Definitions and interpretation.....	4
<b>CHAPTER 2 RIGHTS AND OBLIGATIONS OF THE PARTIES.....</b>	<b>6</b>
Article 3 Multilateral Character of T2S.....	6
Article 4 Duty of loyal cooperation and information .....	7
Article 5 Compliance with eligibility conditions for inclusion in T2S .....	8
Article 6 Contracts with CSDs .....	8
Article 7 Availability of expert personnel .....	9
Article 8 Compliance with Information Security requirements .....	9
Article 9 Obligations of the Eurosystem related to the development of T2S.....	10
Article 10 Obligations of the [NCB] related to the development of T2S.....	11
Article 11 Obligations of the Eurosystem related to testing.....	12
Article 12 Obligations of the [NCB] related to testing.....	13
Article 13 [NCB] Acceptance Tests of T2S .....	13
Article 14 Obligations of the Eurosystem related to Migration .....	14
Article 15 Obligations of the [NCB] related to Migration .....	15
Article 16 Obligations of the Eurosystem related to the provision and use of the T2S Services ..	15
Article 17 Obligations of the [NCB] related to the provision and use of the T2S Services .....	17
Article 18 Monetary policy operations in [currency] .....	18
Article 19 Obligations of the Parties related to the DCA balances .....	18
Article 20 Good governance.....	19
<b>CHAPTER 3 GOVERNANCE AND CHANGE MANAGEMENT.....</b>	<b>19</b>
Article 21 Governance of T2S.....	19
Article 22 Scope of participation rights.....	22
Article 23 Change and Release Management.....	23
Article 24 External Examiner.....	25
Article 25 Crisis management .....	28
Article 26 Amendments.....	29

# Currency Participation Agreement

---

<b>CHAPTER 4 LIABILITY REGIME, COSTS AND NETWORK SERVICE PROVIDER .....</b>	<b>31</b>
Article 27 Standard of liability .....	31
Article 28 Liability rules .....	31
Article 29 Indemnification obligations of the [NCB] for acts of Third Parties .....	33
Article 30 Force Majeure and acts by Third Parties .....	34
Article 31 Costs and Pricing.....	34
Article 32 T2S Network Service Provider.....	35
<b>CHAPTER 5 INTELLECTUAL PROPERTY RIGHTS, CONFIDENTIALITY AND DATA PROTECTION.....</b>	<b>37</b>
Article 33 Intellectual Property Rights.....	37
Article 34 Confidentiality.....	39
Article 35 Data protection .....	40
<b>CHAPTER 6 MISCELLANEOUS.....</b>	<b>41</b>
Article 36 Governing law .....	41
Article 37 Dispute Resolution and Escalation Procedure.....	41
Article 38 Governors' Forum .....	43
Article 39 Duration, suspension and termination .....	44
Article 40 Own fees and costs .....	46
Article 41 Entire agreement.....	46
Article 42 No waiver .....	47
Article 43 Survival .....	47
Article 44 Notices.....	48
Article 45 Invalid or incomplete provisions .....	48
Article 46 Subcontracting.....	48
Article 47 Court proceedings.....	49
Article 48 Extension to other Parties .....	50

# Currency Participation Agreement

---

## LIST OF SCHEDULES

<b>Schedule 1.</b>	Definitions
<b>Schedule 2.</b>	T2S Programme Planning and Monitoring
<b>Schedule 3.</b>	User Testing
<b>Schedule 4.</b>	Migration
<b>Schedule 5.</b>	T2S Service Description
<b>Schedule 6.</b>	T2S Service Level Agreement
<b>Schedule 7.</b>	Pricing
<b>Schedule 8.</b>	Governance
<b>Schedule 9.</b>	Change and Release Management
<b>Schedule 10.</b>	Information Security
<b>Schedule 11.</b>	Exit Management
<b>Schedule 12.</b>	Procedure for Payment of Claims
<b>[where applicable: Schedule 13.]</b>	NCB-specific Requirements]



# Currency Participation Agreement

---

## PREAMBLE

Whereas:

A) On 6 July 2006, the Governing Council decided to explore, in cooperation with the Central Securities Depositories (hereinafter the ‘CSDs’) and other market participants, the possibility of setting up a new Eurosystem service for securities settlement in Central Bank Money, to be called TARGET2-Securities. As part of the Eurosystem’s tasks in accordance with Articles 17, 18 and 22 of the Statute of the European System of Central Banks and of the European Central Bank (hereinafter the ‘Statute of the ESCB’), T2S aims to facilitate post-trading integration by supporting core, neutral and borderless pan-European cash and securities settlement in Central Bank Money so that CSDs can provide their customers with harmonised and commoditised settlement services in an integrated technical environment with cross-border capabilities. As the provision of Central Bank Money is a core task of the Eurosystem, T2S has the nature of a public service. The Eurosystem will provide collateral management services and settlement in Central Bank Money in T2S in euro.

B) Settlement in Central Bank Money avoids liquidity risks and is therefore essential for sound post-trading of securities, and for the financial market in general.

C) On 17 July 2008, the Governing Council decided to launch the T2S project and to provide the resources required until its completion. On the basis of an offer made by the Deutsche Bundesbank, the Banco de España, the Banque de France and the Banca d’Italia (hereinafter the ‘4CB’), the Governing Council also decided that T2S would be developed and operated by the 4CB.

D) On 21 April 2010, the Governing Council adopted the Guideline ECB/2010/2 on TARGET2-Securities of 21 April 2010 (hereinafter the ‘T2S Guideline’)<sup>1</sup>, which lays down the basic foundations of the T2S Programme in its Development Phase and further specifies the governance procedures of the Eurosystem applicable in this context. On the same day, the Governing Council endorsed the Second T2S Protocol on the granting by the Eurosystem Central Banks to each other of a power of attorney to sign the Framework Agreement with the CSDs, in the name and on behalf of all Eurosystem Central Banks.

E) Article 3 of the T2S Guideline provides that the governance of the T2S Programme within the Eurosystem is based on three levels. Level 1 (Governing Council) is responsible for the direction, overall management and control of the T2S Programme, has responsibility for the ultimate decision-making in this thereto and decides on the allocation of tasks not specifically attributed to Levels 2 and 3. Level 2 (T2S Board) is in charge of the tasks assigned to Level 2 within the gen-

---

<sup>1</sup> OJ L 118, 12.5.2010, p. 65.

## Currency Participation Agreement

---

eral framework defined by the Governing Council. Level 3 (4CB) develops and operates T2S. The [NCB] has full and exclusive authority, in particular, to make available, set-up, monitor, block and close the DCAs in [currency] in T2S and shall be closely involved in the governance related to all matters of relevance for Connected NCBs in T2S as further specified in this Agreement.

F) General Principle [10] of T2S provides that T2S will be technically capable of settling currencies other than the euro. As regards the wish of the [NCB] to make the [currency] available for Central Bank Money settlement in T2S, and subject to the signing of this Agreement, including its Schedules ('Agreement'), the Governing Council has approved its eligibility on [date].

G) The Parties recognise that each Party to this Agreement has responsibility for retaining full control over its currency and maintaining its ability to implement monetary policy, exert efficient oversight of its market infrastructure and carry out its obligations for financial stability.

H) The Eurosystem and the [NCB] will exchange sensitive information pursuant to the terms of this Agreement. Moreover, T2S will also process sensitive data stemming from either of the Parties. Therefore, it is the common interest of the Parties to maintain the confidentiality of any such data according to applicable law. Pursuant to Article 37 of the Statute of the ESCB, national legislation or other principles of law, members of the governing bodies and the staff of the Central Banks are required, even after their duties have ceased, not to disclose information of the kind covered by the obligation of professional secrecy.

I) The Parties also acknowledge the importance of cooperating closely with respect to oversight and supervisory requirements that may apply in relation to this Agreement.

J) Notwithstanding the provisions on governance and dispute resolution set out in this Agreement, it is the common understanding of the Parties that they will use their best efforts and act in good faith to prevent any dispute arising out of this Agreement. In the event of any such a dispute, the Parties agree to settle it in an amicable way taking into particular account their respective roles as public authorities in respect of certain rights and obligations to be performed under this Agreement, and will use all possible technical means to resolve any such dispute to the extent they comply with the General Principles of T2S, the Multilateral Character of T2S and the eligibility conditions as set out in [Article 18(1)] OR [Article 18(2)] of the T2S Guideline.

Now, therefore, the Parties agree as follows:

# Currency Participation Agreement

---

## CHAPTER 1

### SCOPE, DEFINITIONS AND INTERPRETATION OF THE AGREEMENT

#### Article 1

##### Subject matter and scope

1. T2S shall be based on a single technical platform integrated with Central Bank RTGS Systems. It is a service provided by the Eurosystem to Participating CSDs allowing for the core, neutral and borderless settlement of securities transactions in Central Bank Money. T2S shall support not only settlement of securities transactions in euro, but will also be open to Eligible NCBs that wish to participate by making their currencies available for Central Bank Money settlement in T2S.
2. The [NCB] shall have no contractual relationship with the 4CB in relation to T2S, other than with each of these four Central Banks as members of the Eurosystem, and shall waive any recourse against the 4CB in connection with matters covered by this Agreement to the extent permissible by applicable law.
3. The Eurosystem shall have no contractual relationship with the Connected NCBs' Dedicated Cash Account Holders related to the use of [currency] for securities settlement in T2S.
4. This Agreement and the General Principles of T2S set out the scope of the T2S Services for the NCBs.
5. This Agreement sets out the Parties' rights and obligations for the Development Phase and the Operational Phase.

#### Article 2

##### Definitions and interpretation

1. In this Agreement references:
  - (a) to applicable laws, Schedules, Annexes or other documents shall be deemed to refer, unless specified otherwise, to the respective applicable laws, Schedules, Annexes or other documents;
  - (b) to this Agreement (whether included in the Articles of the Agreement or in a Schedule or an Annex) shall include the Schedules and the Annexes;
  - (c) to 'include', 'includes', 'including', 'in particular' or 'e.g.' means 'without limitation';

## Currency Participation Agreement

---

- (d) to persons shall include natural and legal persons and shall include the permitted transferees and assignees of such individuals and legal entities;
  - (e) to the holder of any office or position of responsibility include references to such person as is from time to time appointed to exercise the functions of the holder;
  - (f) to any service or other matter or item as described, listed or specified in this Agreement shall include references to such service or other matter or item as removed, replaced, amended or edited from time to time under the terms of this Agreement;
  - (g) words in the plural shall have the same meaning when used in the singular and *vice versa*.
2. The heading and table of contents in this Agreement shall not affect its interpretation.
  3. This Agreement is composed of the Preamble and of Articles 1 to [48] as well as **Schedules 1 to [12] OR [13]**. The Schedules and the Annexes to the Schedules form part of this Agreement and shall have the same force and effect as if expressly set out in Articles 1 to [48]. **Schedule 1** (Definitions) sets out the meaning of terms in this Agreement, which are written with initial capital letters, other than proper nouns or titles of the Schedules to the Agreement. In the event of any conflict or inconsistency between Articles 1 to [48], a Schedule or an Annex, [*for NCBs with such a Schedule 13 only*: and without prejudice to the NCB-specific Requirements as set out in **Schedule 13**], Articles 1 to [48] shall prevail. In the event of a conflict or inconsistency between **Schedule 1** and the other Schedules [*for NCBs with such a Schedule 13 only*: (other than **Schedule 13**)], or between such other Schedules themselves, **Schedule 1** shall prevail over the other Schedules [*for NCBs with such a Schedule 13 only*: other than **Schedule 13**] and shall be used to resolve conflicts or inconsistencies between such other Schedules except in the instances detailed here. In the event of a conflict between a Schedule and an Annex, the terms of the Schedule shall prevail. In the event of a conflict or inconsistency between this Agreement and any other document referenced or referred to it, this Agreement shall prevail.
  4. Where this Agreement contains a German term as a translation of an English term, the German term shall be binding for the interpretation of this Agreement.
  5. The T2S Scope Defining Set of Documents shall be part of this Agreement, unless and to the extent expressly specified to the contrary therein or in this Agreement. In case of such specification, the relevant part of the T2S Scope Defining Set of Documents shall have only interpretative value. The T2S Scope Defining Set of Documents may be complemented from time to time in accordance with **Schedule 9**. The Eurosystem shall aim at ensuring consistency between the T2S Scope Defining Set of Documents and **Schedule 5** at all times. In the event of inconsistencies between documents, the last version of the most detailed document reviewed by the Parties in accordance with Chapter 3 of Annex 8 to **Schedule 2** concerning the issue

## Currency Participation Agreement

---

shall prevail. If a requirement or function is not specified in the GFS or the UDFS, the URD shall prevail. The T2S Documentation that is not part of the T2S Scope Defining Set of Documents is not part of this Agreement unless and insofar expressly specified to the contrary in this Agreement. The T2S Documentation may be complemented from time to time by the Eurosystem in accordance with Annex 8 to **Schedule 2**. The Eurosystem shall make the T2S Documentation available to the [NCB]. The T2S Documentation is not to be understood as amending, being part of, or supplementing this Agreement unless specifically provided for in this Agreement.

### CHAPTER 2 RIGHTS AND OBLIGATIONS OF THE PARTIES

#### Article 3 Multilateral Character of T2S

1. The Parties acknowledge that T2S is multilateral in character in that it aims at facilitating European post-trading integration by supporting securities settlement in Central Bank Money, thereby combining the interests of Central Banks, Participating CSDs and all other T2S Actors. The Parties agree that actions that would have a material negative impact on any of the Connected NCBs or would not be in line with the aim of achieving securities settlement in Central Bank Money are incompatible with the Multilateral Character of T2S. The T2S Services shall be provided to Connected NCBs on the basis of uniform requirements and Governance rules, which include a framework for Specific Changes.
2. The Parties acknowledge that this Agreement shall not cover nor affect or prejudice any current or future role or policy or the exercise of any rights and discretions or obligations of the [NCB] and the Eurosystem, or require the disclosure of any information in the possession of the [NCB] and the Eurosystem in its capacity as operator of a Securities Settlement System or as a T2S User or T2S Actor, except where otherwise provided in this Agreement.
3. The Parties also acknowledge that this Agreement does not cover or affect or prejudice any current or future role or policy or the exercise of any rights and discretions or obligations of the [NCB] or the Eurosystem, or require the disclosure of any information in the possession of the [NCB] or the Eurosystem, with respect to its tasks or responsibilities under the Treaty or applicable law (including, for monetary policy, the supervision or oversight of payment and securities settlement or clearing systems and financial stability).

## Currency Participation Agreement

---

4. The [NCB] shall take, to the extent within the powers of the [NCB], all reasonable measures in relation to Legal and Regulatory Requirements, so that securities transactions in [currency] can be settled in T2S in Central Bank Money in accordance with the process specified in **Schedule 4** and by the time stipulated in **Schedule 2**, as further specified in Article 15, as well as in order to make efficient use of T2S Services and to maintain the Multilateral Character of T2S.
5. The [NCB] shall not prevent the Eurosystem from entering into one or more Parallel CPAs.
6. The Eurosystem shall inform the [NCB] reasonably in advance whenever an Eligible NCB enters into a CPA with the Eurosystem or a CSD enters into a Framework Agreement with the Eurosystem.
7. Notwithstanding the common understanding of the Parties to this Agreement, that its main substantive terms are uniform with regard to all Connected NCBs, and the Multilateral Character of T2S, all rights and obligations of the [NCB] under this Agreement are exercised independently from the other Connected NCBs except where otherwise provided in this Agreement.

### Article 4

#### Duty of loyal cooperation and information

1. In the exercise of its rights and the performance of its obligations under this Agreement each Party shall:
  - (a) act in good faith and cooperate with the other Party closely and transparently in their contractual relations; and
  - (b) promptly give to the other Party notice of facts and information of which it is aware that may reasonably affect its own or the other Party's ability to perform obligations under this Agreement in any material respect.
2. The Eurosystem shall maintain contact with the relevant Union institutions and bodies, and to the extent necessary under this Agreement with national authorities, including the Relevant Competent Authorities.
3. Notwithstanding that General Principle 9 of T2S provides that the primary focus of the Eurosystem is to ensure efficient and sound settlement services in euro, as well as any relevant provisions of the Statute of the ESCB or the Treaty on the Functioning of the European Union, and in line with General Principle 10 of T2S the Eurosystem is committed to treating the [NCB] in the same manner as the Eurosystem, to treating settlement in [currency] in the same manner as settlement in euro, to treating the RTGS System for [currency] in the same manner

## Currency Participation Agreement

---

as TARGET2 and to treating the [NCB's] CMS in the same manner as the CMS(s) of the Eurosystem Central Banks.

### Article 5

#### Compliance with eligibility conditions for inclusion in T2S

1. [For EEA NCB: Pursuant to Article 18(1) of the T2S Guideline, an EEA currency is eligible for use in T2S provided that the Non-euro Area NCB, Other Central Bank or other authority responsible for such currency enters into a CPA with the Eurosystem, and before signing the CPA, the Governing Council has approved the eligibility of the currency.]

**OR** [For non-EEA NCB: Pursuant to Article 18(2) of the T2S Guideline, a currency other than an EEA currency is eligible for use in T2S provided that the Governing Council has approved the eligibility of such currency, if all the following conditions are met:

- (a) the legal, regulatory and oversight framework applicable to settlement in that currency provides substantially the same or a higher degree of legal certainty as that in force in the Union;
  - (b) the inclusion of such currency in T2S would have a positive impact on the contribution of T2S to the Union securities settlement market;
  - (c) the Other Central Bank or other authority responsible for such currency enters into a mutually satisfactory CPA with the Eurosystem.]
2. [For non-EEA NCB: The [NCB] shall ensure that the eligibility conditions of the [currency] as set out in Article 18(2)(a) of the T2S Guideline are met on an ongoing basis.]

### Article 6

#### Contracts with CSDs

For the avoidance of doubt, the [NCB] acknowledges that pursuant to Article 16(3) of the T2S Guideline contracts with CSDs shall be approved by the Governing Council and subsequently signed by the Eurosystem Central Bank of the country where the seat of the CSD is located, or by the ECB for CSDs located outside the euro area, in either case acting in the name and on behalf of all Eurosystem Central Banks, and that, in relation to Ireland, the contract shall be signed by the Eurosystem Central Bank of the Member State that has notified the Securities Settlement System to ESMA in accordance with Article 10 of the Settlement Finality Directive.

# Currency Participation Agreement

---

## Article 7

### Availability of expert personnel

Each Party shall ensure that sufficient and qualified personnel with appropriate expertise and training for the tasks in which they are engaged, are used to perform the duties and obligations under this Agreement.

## Article 8

### Compliance with Information Security requirements

1. The Eurosystem shall in accordance with and as described in **Schedule 10**:
  - (a) implement the Information Security framework for T2S;
  - (b) implement a process to manage Information Security in T2S by: (i) regularly reviewing the implementation and (ii) regularly aligning the T2S Security Requirements with technical developments;
  - (c) maintain the T2S Threat Catalogue;
  - (d) perform all activities related to Information Security in accordance with **Schedule 10**;
  - (e) report the results of Information Security reviews and provide additional information on request to the [NCB];
  - (f) report Information Security incidents to the [NCB] in accordance with the provisions set out in **Schedule 10**;
  - (g) provide all other relevant information to the [NCB] to allow the latter to fulfil its own risk management obligations and in particular inform the [NCB] if the Eurosystem decides to change its Information Security policy.
2. In view of ensuring Information Security for T2S, the [NCB] shall:
  - (a) ensure its own compliance with Information Security requirements in relation to T2S according to its internal standards, Legal and Regulatory Requirements and/or best practices;
  - (b) report Information Security incidents to the Eurosystem, if T2S or other T2S Actors might be impacted by such incidents; and
  - (c) report to the Eurosystem newly identified threats or detected gaps that might threaten T2S Information Security.
3. The Parties shall cooperate as follows:



## Currency Participation Agreement

---

- (a) The Eurosystem shall at least on a yearly basis deliver for review to the [NCB] the T2S Information Security Risk Evaluation Table and the T2S Information Security Risk Treatment plan, as further specified in Section 4.2 of **Schedule 10**.
  - (b) The Eurosystem shall maintain a consolidated action plan for all risks appearing in a T2S Information Security Risk Treatment plan which require follow-up, and shall deliver for review to the [NCB] an updated version of the action plan at least on an annual basis, as further specified in Section 4.2.2 of **Schedule 10**.
  - (c) The Eurosystem shall set up a multilateral coordination substructure, in accordance with the Governance, to coordinate and monitor the T2S Information Security Risk Management activities, as further specified in Section 4.3 of **Schedule 10**.
  - (d) If a disagreement arises in the substructure, each Party may escalate the issue to the Steering Level and, if the disagreement persists, may initiate the Dispute Resolution and Escalation Procedure, as further specified in Section 4.3 of **Schedule 10**.
  - (e) If a new Information Security risk is identified, or if an existing Information Security risk obtains a higher likelihood or impact score, the Eurosystem shall communicate such changes to the [NCB] in accordance with the incident response times specified in **Schedule 6**, as further specified in Section 4.3 of **Schedule 10**.
4. Any matters related to operational risk, which are not covered by this Article or in **Schedule 10**, shall be managed directly by the Steering Level.
  5. The Eurosystem will implement an appropriate risk management framework and inform the [NCB] monthly about the risk situation.

### Article 9

#### Obligations of the Eurosystem related to the development of T2S

The Eurosystem shall:

- (a) establish T2S in performance of its public tasks and in accordance with the T2S Scope Defining Set of Documents and **Schedule 5** and use reasonable efforts to allocate appropriate resources to its implementation and to respect the milestone deliverables set out in **Schedule 2** in line with the agreed procedure for modifications as defined in **Schedule 2**;
- (b) set up and maintain the T2S Programme Plan as well as assess and adjust the T2S Programme Plan, with a view to ensuring effective implementation of the T2S Services;
- (c) report to and inform the [NCB] in accordance with **Schedule 2** on the progress achieved;

## Currency Participation Agreement

---

- (d) make available T2S Documentation to the [NCB] in line with **Schedule 2**;
- (e) implement Common and Specific Changes to the T2S Services as requested by the [NCB] and managed by the Eurosystem in accordance with Article 23 and **Schedule 9**;
- (f) provide reasonable support to the [NCB] during the Development Phase on request by the [NCB]; and
- (g) submit processes and reasonable timelines in line with **Schedule 9** to allow the [NCB] to review and agree on the preparation of the T2S Documentation as provided for in Article 10.

### Article 10

#### Obligations of the [NCB] related to the development of T2S

As further specified in the relevant Schedules, the [NCB] shall participate in and contribute to the development of T2S as follows:

- (a) it shall cooperate with the Eurosystem by adapting its own systems and processes, especially by ensuring adequate system interfaces and, to the extent within the power of the [NCB], reliable connections, and allocate appropriate resources to the implementation of its project plan, assess and adjust such project plan, to allow for the [NCB's] operational and technical readiness for the use of the T2S Services and for the timely initiation of provision of such T2S Services. For the avoidance of doubt, such obligation of the [NCB] to adapt its own systems does not include an obligation to develop a full interface allowing Payment Banks to connect indirectly to T2S via the [NCB];
- (b) it shall support the Eurosystem in the preparation of the T2S Documentation in accordance with Annex 8 to **Schedule 2**,
- (c) it shall inform the Eurosystem whenever it has in its possession material information, whether of a technical or operational nature or in relation to Legal and Regulatory Requirements, that would in the absence of any action by the Eurosystem lead to a material adverse effect on the effective and harmonised functioning of the T2S Programme and/or T2S Services [for non-EEA currency: (including compliance with the eligibility conditions set out in Article 18(2)(a) of the T2S Guideline)];
- (d) it shall use reasonable efforts to respect the milestone deliverables set out in **Schedule 2**, as applicable, set up its own project plan for the implementation of the T2S Programme, allocate resources to successive versions of the T2S Documentation, with the view to ensuring effective use of the T2S Services in accordance with the timelines referred to in

## Currency Participation Agreement

---

Article 9[(g)], and report on the progress of its project plan and its readiness for the effective implementation of the T2S Services;

- (e) it shall provide appropriate support to the Eurosystem in its relationship with the Relevant Competent Authorities responsible for Legal and Regulatory Requirements;
- (f) it shall cooperate with the Eurosystem and a Participating CSD located in the same country as the [NCB] as regards that Participating CSD's implementation of the T2S Programme; and
- (g) the [NCB] shall participate in and contribute to the work of the relevant groups set up or supported by the Eurosystem in relation to the Governance.

### Article 11

#### Obligations of the Eurosystem related to testing

As further specified in **Schedule 3**, the Eurosystem shall:

- (a) coordinate the User Testing activities and communication between the [NCB] and the Central Banks whose respective currencies are available for settlement in T2S, as well as between the [NCB] and Participating CSDs participating in the User Testing activities;
- (b) inform the [NCB] about the results of User Testing as defined in **Schedule 3**;
- (c) prepare and execute the EAT, and provide regular progress reporting as well as an assessment report confirming the compliance of T2S with **Schedule 5** and the T2S Scope Defining Set of Documents before the start of User Testing;
- (d) define the NCB certification tests required to assess that the [NCB's] systems cannot harm T2S due to an inappropriate technical communication or operational procedure;
- (e) define the DCA Holder Certification Tests for those DCA Holders which [NCB] has authorised to connect to T2S with an A2A connection and for those DCA Holders which [NCB] has authorised to connect to T2S with a U2A connection which are required to assess that the systems of the directly connected DCA Holders of the [NCB] cannot harm T2S due to an inappropriate technical communication or operational procedure;
- (f) for all directly connected DCA Holders of [NCB], the Eurosystem shall undertake the DCA Holder Certification process; the Eurosystem shall upon request provide [NCB] with the results of such DCA Holder Certification process.
- (g) prepare the necessary non-functional tests and execute these non-functional tests in order for the Eurosystem to confirm the non-functional compliance of T2S;
- (h) remedy any material deficiency defined as critical defect (priority 1) and, for any defect defined as high defect (priority 2), either directly resolve the defect or, if agreed with the [NCB], as a first step, provide a technical or procedural workaround and, as a second

## Currency Participation Agreement

---

step, resolve the defect within a specific timeframe to be defined along with the work-around to ensure that the T2S Services are established in accordance with the principles set out in **Schedule 5** and the T2S Scope Defining Set of Documents;

- (i) provide reasonable support for testing activities of the [NCB] in the different stages of User Testing; and
- (j) cooperate with the [NCB] in respect of its own acceptance tests of the relevant T2S Services in accordance with Article 13.

### Article 12

#### Obligations of the [NCB] related to testing

As further specified in **Schedule 3**, the [NCB] shall:

- (a) support the Eurosystem in the preparation of the overall User Testing calendar by providing the Eurosystem with its proposed test plan and User Testing calendar of its activities;
- (b) execute the mandatory test cases and test scenarios for NCB certification within the period foreseen in **Schedule 2** for the migration wave in which it is participating;
- (c) in good time before the period foreseen in Schedule 2 for the migration wave in which it is participating, provide the Eurosystem with the necessary information about those DCA Holders which have been authorised to connect to T2S with an A2A connection and those which have been authorised to connect to T2S via a U2A connection. For the avoidance of doubt, the [NCB] is not responsible for the certification of its DCA Holders.
- (d) cooperate with the Eurosystem in respect of its acceptance tests for the relevant T2S Services in accordance with Article 13.

### Article 13

#### [NCB] Acceptance Tests of T2S

1. Following the Eurosystem's notification of its readiness to fulfil synchronisation point 8 (start bilateral interoperability testing) according to Annex 9 to **Schedule 2**, the [NCB] shall be entitled to test the compliance of the relevant T2S Services with **Schedule 5** and the T2S Scope Defining Set of Documents in accordance with the methodology stated in this Article and in **Schedule 3**.
2. In case the [NCB] chooses to perform the tests defined in paragraph 1, the [NCB] shall finalise such tests within six months following the Eurosystem's notification of its readiness to

## Currency Participation Agreement

---

fulfil synchronisation point 8 (start bilateral interoperability testing), unless provided otherwise in **Schedule 2**. If the [NCB] discovers that the relevant T2S Services do not comply with **Schedule 5** and/or the T2S Scope Defining Set of Documents, it shall follow the procedures laid down in Section 5.3 of **Schedule 3**.

3. Notwithstanding the [NCB]'s decision to perform the tests as described in paragraphs 1 and 2, the [NCB] shall provide to the Eurosystem in writing and within six months following the Eurosystem's notification of its readiness to fulfil synchronisation point 8 (start bilateral interoperability testing), whether or not it accepts the relevant T2S Services as compliant with **Schedule 5** and the T2S Scope Defining Set of Documents.
4. If the [NCB] notifies the Eurosystem that it does not accept the relevant T2S Services as compliant with **Schedule 5** and the T2S Scope Defining Set of Documents, it shall promptly, and in no case later than within five working days following such notification deliver a report to the Eurosystem describing all cases of non-compliance it has identified (non-compliance notification).
5. Following a Eurosystem's notice to the [NCB] that the Eurosystem has remedied individual or all cases of material non-compliance, the [NCB] shall test the error correction.
6. When the [NCB] finds that none of the reported cases of material non-compliance continues to exist, it shall provide a confirmation that it accepts the relevant T2S Services as compliant with **Schedule 5** and the T2S Scope Defining Set of Documents (compliance confirmation) in writing without undue delay.
7. This Article does not affect the [NCB's] termination rights according to Article 39.

### Article 14

#### Obligations of the Eurosystem related to Migration

As further specified in **Schedule 4**, the Eurosystem shall:

- (a) establish the necessary procedures and tools for Migration which will, *inter alia*, support the [NCB] in suspending or reversing its Migration if the conditions for Migration, as defined in **Schedule 4**, cannot be satisfied; and
- (b) provide the [NCB] with support related to its activities necessary for completing Migration or suspending Migration, if necessary.

# Currency Participation Agreement

---

## Article 15

### Obligations of the [NCB] related to Migration

As further specified in **Schedule 4**, the [NCB] shall:

- (a) adjust its internal systems, processes, interfaces and connections to enable its Migration to T2S in compliance with the T2S Documentation, and to achieve operational and technical readiness for the use of the T2S Services;
- (b) set up its own project plan for the Migration and do what is reasonably required to ensure that its Dedicated Cash Account Holders are able to migrate to the T2S-enabled Services within the timeframe specified in **Schedule 2**;
- (c) migrate to T2S in accordance with the process specified in **Schedule 4** and by the timeframe provided in **Schedule 2**, or, if it is unable to migrate by the scheduled date, at the latest it shall migrate by the date of the contingency migration wave, as specified in **Schedule 2**; and
- (d) cooperate with the Eurosystem in documenting that its Migration has been successfully completed.

## Article 16

### Obligations of the Eurosystem related to the provision and use of the T2S Services

1. For the provision and use of T2S Services, the Eurosystem shall:
  - (a) provide the [NCB] with the T2S Services and system functionality as described in **Schedule 5**;
  - (b) provide the [NCB] with all necessary rights to exclusively exercise full control in real time over the DCAs in [currency] in T2S, including the right to real-time blocking and unblocking with immediate effect and to the real-time initiation of their closure with effect on the next Settlement Day, however without prejudice to the finality and irrevocability of entries on such DCAs on the T2S Platform as set out in Article 19;
  - (c) provide the [NCB] with the right to the real-time initiation of a change (being applicable in T2S on the next Settlement Day, except in special circumstances where specific manual procedures according to the MOP shall be foreseen for implementation in real-time) as regards the following:
    - (i) the usage of selected securities in its respective currency for auto-collateralisation,
    - (ii) the credits granted for securities settlement in [currency] in T2S,

## Currency Participation Agreement

---

- (iii) the determination of the individual ISINs which may be used as collateral for individual credits in T2S,
  - (iv) the valuation of each ISIN, and
  - (v) the identification of the accounts on which the collateral may be held for credit with the [NCB],
- in each case if relevant for the [NCB's] collateral procedure;
- (d) implement Common and Specific Changes to the T2S Services as requested by the [NCB] and managed by the Eurosystem in accordance with Article 23 and **Schedule 9**;
  - (e) endeavour to maintain the T2S Services to support, in cooperation with the [NCB], ongoing compliance with Legal and Regulatory Requirements, without prejudice to the application of Article 23 and **Schedule 9** to changes that may need to be implemented as a result of such requirements;
  - (f) suspend the settlement in [currency] if so requested by the [NCB];
  - (g) reinstate operations to permit use of the T2S Services following a failure as specified in **Schedule 6**;
  - (h) provide the [NCB] with financial statements, reports and other information on T2S on a regular basis that fairly represent the business and financial conditions, results of operations and state of the cost recovery in relation to T2S on the respective dates or for the respective periods covered by such financial statements, reports and other information; and
  - (i) update the T2S Documentation in a timely manner.
2. Changes to the T2S Platform or T2S Business Application that need to be implemented urgently to restore or continue the provision of the T2S Services in accordance with the service levels specified in **Schedule 6**, may be autonomously decided and implemented by the Eurosystem in accordance with **Schedule 6** and the MOP, provided that such a change does not in any way diminish the right of the [NCB] to exclusively exercise control over its DCAs. The Eurosystem shall inform the [NCB] as soon as reasonably practicable on the nature and characteristics of the changes and the time in which the change shall be implemented.
3. The Eurosystem shall make available to the [NCB] a monthly Service Level Report to determine the degree of the Eurosystem's compliance with **Schedule 6**, in particular as regards the KPIs. If the Eurosystem fails to meet any of the KPIs, it shall in cooperation with the [NCB]:
- (a) investigate the underlying cause of the failure;
  - (b) take necessary measures to minimise the impact of the failure;

## Currency Participation Agreement

---

- (c) take necessary measures to prevent the failure from recurring; and/or report on the cause, the status and the remedies required to prevent recurrence of the failure.

### Article 17

#### Obligations of the [NCB] related to the provision and use of the T2S Services

1. The [NCB] shall use the T2S Services, once (a) the User Testing is completed as specified in Article 15 and **Schedule 3** and (b) Migration has been successfully completed as specified in Article 15 and **Schedule 4**.
2. In pursuance of its obligations to use the T2S Services, the [NCB] shall, in particular:
  - (a) perform the duties and responsibilities assigned to it in **Schedule 6**, and in particular:
    - (i) according to its rules applicable to its RTGS Participants, make available, set up and close DCAs of its RTGS Participants in [currency] for all securities-related payment transactions in [currency] in T2S; for the avoidance of doubt the Parties agree that the Eurosystem is not responsible for monitoring the DCAs;
    - (ii) set up and manage static data, access rights and configuration data pertaining to its Dedicated Cash Account Holders and its own participation in T2S;
    - (iii) provide for the interoperability of its own RTGS System in accordance with the timing provisions specified in **Schedule 2** and, where applicable, its Collateral Management System with T2S to ensure the smooth functioning of the relevant connections;
    - (iv) based on the operational decision of the [NCB], provide auto-collateralisation in [currency] to its Dedicated Cash Account Holders according to its own terms and conditions;[and]
    - (v) if the auto-collateralisation functionality is used, provide to the Eurosystem a list of eligible securities and the Collateral Value for the securities identified as eligible for auto-collateralisation as well as any other data necessary for the Eurosystem to judge the eligibility of securities for a specific participant (including, in relation to close links and the identification of the accounts on which the collateral may be held, if relevant for the [NCB's] collateral procedure) [.][]; and]
    - (vi) [for non-EEA currency: inform the Eurosystem without delay after having gained knowledge of Legal or Regulatory Requirements that might have a material impact on the participation of the [NCB] in T2S (including compliance with the eligibility conditions set out in Article 18(2)(a) of the T2S Guideline).]



## Currency Participation Agreement

---

- (b) ensure that the agreements with its Dedicated Cash Account Holders, to the extent that they are not directly connected to T2S and use Connectivity Services via the [NCB] if the [NCB] chooses to offer such services, contain provisions that are consistent with Article 28 and Article 32 regarding the use of Connectivity Services by the [NCB]; and
  - (c) support the resumption of the T2S Services following an event of a failure as specified in **Schedule 6**.
3. The [NCB] shall review, comment on, and accept or reject the Eurosystem report referred to in paragraph 3 of Article 16. If the [NCB] rejects the report in whole or in part, or the remedies proposed by the Eurosystem for preventing recurrence of not meeting the KPIs, it may revert to the Dispute Resolution and Escalation Procedure.

### Article 18

#### Monetary policy operations in [currency]

The [NCB] shall be entitled to undertake settlement of monetary policy transactions in Central Bank Money in [currency] outside T2S provided that: (i) the Eurosystem has received all relevant information on the technical functioning of such settlement; and (ii) such settlement neither requires changes to nor negatively affects, the T2S functionality as described in the T2S Scope Defining Set of Documents. The Eurosystem shall grant to the Participating CSD(s) designated by the [NCB] a derogation from the eligibility criterion set out in Article 15(1)(e) of the T2S Guideline in relation to such monetary policy transactions in line with the Decision ECB/2011/20, the procedure of granting such derogation shall be finalised as soon as possible after the Eurosystem has received all relevant information set out under (i). Such derogation shall not be unreasonably withheld by the Eurosystem.

### Article 19

#### Obligations of the Parties related to the DCA balances

1. DCA balances of the [NCB] operated on the T2S Platform shall only be changed in T2S. The [NCB] shall ensure as regards its operational processes and contractual terms that entries on the DCAs on the T2S Platform have immediate legal effect, with regard to the finality and irrevocability of the settlement and shall make all necessary arrangements to this effect. Moreover, with regard of the moment of entry of Transfer Orders into a system and their irrevocability, in accordance with the Settlement Finality Directive, the Eurosystem shall inform the [NCB] and take into account the [NCB's] views as regards the harmonisation efforts to which

## Currency Participation Agreement

---

Participating CSDs are committed under the respective Framework Agreement related to harmonisation of the different rules applicable in the systems of the different CSDs.

2. The Parties agree that all matters relating to the DCAs (including the validity and enforceability of any debits and credits to the DCAs) are governed by the law of the [NCB].

### Article 20

#### Good governance

In order to avoid conflicts of interest between the [NCB's] operating and regulatory functions in relation to T2S, the [NCB] shall ensure that members of the T2S Board do not participate in any oversight or other activity that could create a conflict of interest, as specified in the rules of procedures of the T2S Board.

## CHAPTER 3

### GOVERNANCE AND CHANGE MANAGEMENT

#### Article 21

#### Governance of T2S

1. Without prejudice to Article 37 the governance framework applicable during the development and operation of the T2S Services is specified in this Article and **Schedule 8**. In particular the following principles of relevance to Connected NCBs shall apply:
2. Based on Article 127 of the Treaty on the Functioning of the European Union and Article 3 of the Statute of the ESCB, in the T2S context, the Eurosystem shall in particular:
  - (a) exclusively exercise full control over all cash accounts in euro in T2S, i.e. operate the cash accounts it holds for its banks and safeguard the integrity of the euro which, for the purposes of this Agreement, includes the implementation of monetary policy including all central bank credit operations as well as settlement in Central Bank Money in the euro;
  - (b) contribute to the smooth conduct of policies pursued by the competent authorities relating to the prudential supervision of credit institutions and the stability of the financial system;
  - (c) ensure that it does not distort a level playing field for market participants; and
  - (d) exert efficient oversight of market infrastructure while preserving the separation of this function from its operational activities of T2S.

## Currency Participation Agreement

---

3. Subject to **Schedule 8**, Connected NCBs shall have the same rights in T2S as the Eurosystem in relation to their respective currencies.
4. The Eurosystem shall have control and participation rights in the Governance of T2S in the performance of its tasks under the Treaty on the Functioning of the European Union and the Statute of the ESCB and in its capacity as owner and operator of T2S. In particular, this includes the ability to recover its costs and to operate T2S in a safe and efficient manner with due consideration of the rights, interests, prerogatives and obligations of the T2S Stakeholders in line with the Multilateral Character of T2S. The Governing Council shall have ultimate decision making powers.
5. The Connected NCBs shall have control and participation rights in accordance with the Governance framework of T2S, in particular through their participation in the relevant Governance bodies as set out in this Article and the decision-making process as outlined in **Schedule 8**.
6. Without prejudice to the ultimate decision-making powers of the Governing Council as set out in **Schedule 8**, and the decision-making bodies of the Connected NCBs, the T2S Governance bodies shall comprise:
  - (a) the T2S Board, which replaces the T2S Programme Board established by Decision ECB/2009/6;
  - (b) the CSD Steering Group (CSG), whose mandate and composition are annexed to Schedule 8 of the Framework Agreement;
  - (c) the Non-euro Currencies Steering Group (NECSG), whose mandate and composition are set out in **Schedule 8**;
  - (d) the Governors' Forum, whose mandate and composition are set out in **Schedule 8**;
  - (e) the T2S Advisory Group (AG), whose mandate and composition are set out in the Annex to the T2S Guideline; and
  - (f) the National User Groups (NUGs), whose mandate and composition are set out in the Annex to the T2S Guideline.

These T2S Governance Bodies shall draft their respective rules of procedure once they have been established.
7. The [NCB] shall have all necessary rights to exclusively exercise full control in real time over the DCAs in [currency] in T2S, including the right to real-time blocking and unblocking with immediate effect and to close them with immediate effect.

## Currency Participation Agreement

---

8. The [NCB] shall have the right of the real-time initiation of a change being applicable in T2S on the next Settlement Day, except in special circumstances where the MOP provides for specific manual procedures for implementation in real-time as regards:
  - (a) the usage of selected securities in its respective currency for auto-collateralisation,
  - (b) the credits granted for securities settlement in [currency] in T2S,
  - (c) the determination of the individual ISINs which may be used as collateral for individual credits in T2S,
  - (d) the valuation of each ISIN, and
  - (e) the identification of the accounts on which the collateral may be held for credit with the [NCB],in each case if relevant for the [NCB's] collateral procedure.
9. Any amendment to this Agreement or a system change shall be without prejudice to the rights specified in paragraph 8.
10. The refusal of a Change Request by the Connected NCB(s) shall be justified by the need to safeguard central bank functions, i.e. the Connected NCB(s) shall consider the Change Request inappropriate for reasons linked to their responsibilities in terms of safeguarding the integrity of the respective currency or in relation to financial stability.
11. In case of disagreement between the Governing Council and the Connected NCB(s) over the latter's refusal of a Change Request or over any other decision by the T2S Board, the Governors' Forum shall be asked to find an amicable solution for this matter in line with Article 37 and Article 38.
12. If the dispute in the Governors' Forum is based on the refusal of a Change Request by Connected NCB(s) for one of the reasons set out in paragraph 10, the Eurosystem shall have to justify overruling the refusal either (i) with the need to safeguard general Eurosystem central bank functions (safeguarding the euro, financial stability, no distortion of competition) or (ii) with the need to preserve the integrity of the T2S Platform for economic, functional or technical reasons.
13. If no amicable solution can be found, then the concerned Connected NCB(s) shall have the right to exit T2S within 24 months in line with paragraph 4 of Article 38.

# Currency Participation Agreement

---

## Article 22

### Scope of participation rights

1. The participation rights of the [NCB] during the Development Phase shall include the following:
  - (a) the right to submit Change Requests in accordance with the Change and Release Management procedure as described in Article 23 and **Schedule 9**;
  - (b) the right to be represented and to participate in the Governance as specified in Article 21 and in **Schedule 8**; and
  - (c) the right to obtain information as otherwise provided for in this Agreement.
2. The participation and controlling rights of the [NCB] during the Operational Phase shall include the following:
  - (a) the right to submit Change Requests in accordance with the Change and Release Management procedure set out in Article 23 and **Schedule 9**;
  - (b) the right to receive a report on the technical and operational examinations by the External Examiner in line with the multi-year T2S examination plan and the [NCB's] right to request special examinations by the External Examiner, and to have access to the underlying documentation in accordance with Article 24 [if relevant for a Connected NCB: "and Schedule 13"];
  - (c) the right to receive on request and without delay all information, related to the administration and bookings on the DCAs opened by the [NCB], related to the associated intra-day credit, collateral and accounts where the collateral is held, including but not limited to all relevant manual and system-generated reports, routine descriptions and material allowing for the tracing of errors of administration;
  - (d) the right to be represented and to participate in the Governance as specified in Article 21 and in **Schedule 8**;
  - (e) the right to obtain information as otherwise provided for in this Agreement; and
  - (f) other rights granted by this Agreement.
3. The rights set out in paragraphs 1 and 2 shall be exercised without prejudice to the Multilateral Character of T2S and the principle of central bank independence set out in Article 130 and Article 282(3) of the Treaty on the Functioning of the European Union and Article 7 of the Statute of the ESCB as well as in relevant national legislation.

## Article 23

### Change and Release Management

1. The Parties may propose Change Requests for the T2S Business Application and the T2S Scope Defining Set of Documents, requirements for T2S Network Service Providers and specifications for the Value-added Connectivity Services. Such proposal shall be made and dealt with in accordance with **Schedule 9**.
2. The Change and Release Management process shall adhere to the following principles:
  - (a) T2S is aimed at accommodating market evolution and supporting innovation;
  - (b) without prejudice to the right of the [NCB] to submit a request for the implementation of Specific Changes, new or changed services within T2S shall be provided with the objective of being available to all Central Banks and Participating CSDs in T2S, and through them to T2S Users;
  - (c) without prejudice to the powers of the Central Banks as specified in **Schedule 8**, no individual Central Bank or Participating CSD shall have a veto right with respect to the approval of a Change Request;
  - (d) T2S shall endeavour to support the [NCB's] compliance with its Legal and Regulatory Requirements, to the extent that the Eurosystem is informed by the [NCB] about such requirements and to the extent that they are compatible with the Multilateral Character of T2S;
  - (e) it is the [NCB's] responsibility to involve its user communities throughout the whole Change and Release Management;
  - (f) the Eurosystem shall continue to be committed to communicating information in a transparent manner towards the market in line with established T2S practices;
  - (g) the development of specific functionalities to accommodate national specificities shall be limited as much as possible. Instead, where applicable, building the necessary interfaces to let the Central Banks and Participating CSDs offer these national specificities on their platforms, with no impact on T2S, shall be favoured;
  - (h) in the case of changes in respect of Legal and Regulatory Requirements which apply only to one or a few Central Banks or Participating CSDs, Specific Changes in accordance with paragraph 3 shall be available; and
  - (i) sufficient time shall be allotted for implementing any change needed by the Eurosystem to develop the T2S Services on a consistent basis and provide enough lead time for the Central Banks and Participating CSDs to change their own internal systems, processes, interfaces and connections accordingly.

## Currency Participation Agreement

---

3. The following principles are applicable to Specific Changes:
  - (a) a Central Bank or a Participating CSD which has a specific need triggered by Legal and Regulatory Requirements or by innovation/improvements has the possibility to propose a new functionality provided that it does not endanger the Lean Scope of T2S and is not incompatible with the Multilateral Character of T2S; and
  - (b) the requesting Central Bank or Participating CSD shall formally commit itself to bear the financial consequences of the Specific Change in accordance with **Schedule 7**; and/or
  - (c) the associated costs shall be shared among all Central Banks and Participating CSDs making use of the functionality in accordance with **Schedule 7**; and
  - (d) the Specific Changes shall be approved in accordance with **Schedule 9**; and
  - (e) no Specific Change may be implemented if this imposes changes to existing features, functionalities, processes or interfaces, or a deterioration of the service level of other Central Banks or Participating CSDs which have not approved such Specific Change, unless such other Central Banks or Participating CSDs agree to it.
4. In accordance with paragraph 2 of Article 33, but subject to paragraph 3 of Article 33, the [NCB] shall waive any IPRs that it may have acquired in connection with the proposed T2S Services or that may have arisen in the context of the Change and Release Management process. If any other legal or natural person directly or indirectly with the Change and Release Management process has acquired IPRs in connection with the proposed changes, the [NCB] shall: (i) inform the Eurosystem as soon as it becomes aware of potential IPRs vested in such a legal or natural person; and (ii) use its best endeavours to ensure that such a legal or natural person also waives any IPRs acquired in the abovementioned context.
5. The full financial consequences related to Common Changes and Specific Changes shall be recovered in accordance with **Schedule 7**.
6. Subject to paragraph 3, as regards a Specific Change requested by the [NCB] related to safeguarding the currency and/or financial stability as part of crisis management measures, the Eurosystem shall make such Change Request only transparent to Connected Central Banks and Participating CSDs on request of the [NCB] until no later than the point in time the change has been formally taken up in a release, provided that the [NCB] has formally committed to bear the financial consequences of the change.
7. In the case of refusal to implement changes triggered by Legal and Regulatory Requirements, the Governing Council shall provide a full written explanation of the reasons for the refusal.
8. Authorised changes and defect resolutions the implementation of which is pending are prioritised based on a scoring mechanism. The definition of the release is based on this priority rat-

## Currency Participation Agreement

---

ing taking into account the business and legal criticality of changes, the associated risks, budgetary implications and the capacity for Common Changes and Specific Changes. The approval of the content of the release and the final prioritisation are carried out as described in **Schedule 8**.

### Article 24

#### External Examiner

1. Without prejudice to the principle of central bank independence in the performance of its public tasks, as established under Article 130 and Article 282(3) of the Treaty on the Functioning of the European Union and in the relevant national legislation, the Eurosystem shall facilitate the [NCB's] and its auditors' (meaning any auditor which has the right to audit the [NCB] pursuant to national legislation or central bank policy) compliance with applicable national legal requirements in relation to the [NCB's] connection to T2S under this Agreement. The Parties agree that without prejudice to the abovementioned principle to the extent legally possible recourse would be made to the External Examiner in line with the following provisions[.], *only relevant for Connected NCB having a Schedule 13 to that effect*: provided that nothing in this article shall be interpreted as diminishing the rights granted to the [NCB's] auditors in **Schedule 13**.]
2. The performance of the T2S Services shall be subject to technical and operational examinations performed by the External Examiner appointed by the Governing Council on the proposal of the CSG and after having consulted the NECSG on this proposal. The [NCB] shall not bear any of the costs of the External Examiner for these regular examinations or the special examinations due to incidents specified in paragraph 5.
3. The External Examiner shall perform its services within the scope set by the Governing Council and in accordance with internationally recognised audit standards including but not limited to the Statement on Standards for Attestation Engagement (SSAE) No 16 or International Standards for Assurance Engagements (ISAE) No 3402 or any replacement of these standards. The External Examiner shall be changed every four years.
4. The Governing Council shall set the External Examiner's mission statement and a multi-year examination plan, taking into account examination items proposed by the NECSG. Without prejudice to paragraph 5, the scope of the regular and any special examinations shall be limited to the provision of T2S Services or directly related aspects. The objective of these examinations is to give to the NECSG reasonable assurance about whether (i) the organisation set by the Eurosystem meets the obligations established in this Agreement and (ii) the controls implemented by the Eurosystem are suitably designed to meet the security objectives.



## Currency Participation Agreement

---

Moreover, the External Examiner shall deliver an opinion on the effectiveness of the controls performed by the Eurosystem on the basis of the results of the compliance check reviews and of the risks assessment and related treatment plans managed by the Eurosystem. A Connected NCB – to the extent feasible, as coordinated through the NECSG – may also propose to the Governing Council special examinations to be conducted by the External Examiner outside the multi-year examination plan.

5. Where a special examination is necessary because of a severe incident or a material and ongoing problem which has disrupted the proper functioning of the T2S Platform or the provision of T2S Services, the External Examiner shall have access to all relevant documentation.
6. Following the submission of the External Examiner's report of its regular examination, the NECSG shall hold with the External Examiner an annual meeting, or in case of a special examination, an extraordinary meeting, to review the submitted report and to discuss the solutions to the identified issues. The report and recommended solutions for the identified issues shall then be submitted to the Governing Council. Within three months of receiving the report, the Governing Council shall reply whether it accepts or rejects each of the recommended solutions. If it accepts a recommendation, the Governing Council shall describe how it intends to implement such recommendation and in what timeframe. The External Examiner shall then monitor the Eurosystem's progress on implementing the accepted recommendations and report back to the NECSG at the annual meeting. If a recommendation is rejected, the Governing Council shall communicate the reasons to the NECSG.
7. Without prejudice to paragraphs 4, the [NCB] shall have the right to: (i) propose to the NECSG items for the regular examinations and for special examinations to be conducted by the External Examiner; (ii) for the avoidance of doubt subject to the confidentiality requirements of Article 34 receive all of the External Examiner's reports and supporting documentation relevant to the [NCB's] use of T2S Services; and (iii) request the External Examiner to provide additional explanations to the NECSG in the course of meetings referred to in paragraph 6 or in written form following such meetings and falling within its remit. The [NCB] and/or its auditors may propose directly to the Governing Council special examinations to be conducted by the External Examiner provided that the [NCB] bear the costs associated with such special examinations.
8. The Governing Council shall communicate to the NECSG, to the [NCB] and/or to its auditors the reasons for refusing to include items for regular or special examination to be conducted by the External Examiner on the proposal of the NECSG, the [NCB] and/or its auditors as provided for in paragraph 7. The NECSG, the [NCB] and/or its auditors may make new proposals to the Governing Council with the understanding that the Connected NCBs and the Eurosystem would use their best efforts to come to a mutually agreeable solution.

## Currency Participation Agreement

---

9. The Eurosystem shall ensure that the External Examiner has the following rights and obligations related to the performance of its examinations:
- (a) the External Examiner shall contact the Eurosystem through the indicated contact persons. The External Examiner shall give the Eurosystem 14 calendar days prior notice before starting the regular or special examination and shall notify to the Eurosystem the following: (i) the object of the examination; (ii) the names of the authorised representatives of the External Examiner who will carry out the examination; (iii) the Eurosystem offices at which the examination is to be conducted; (iv) the methods to be applied; and (v) the timescale;
  - (b) the External Examiner may examine technical and operational documentation and records, whether in written or electronic form, directly relevant for assessing the performance of the T2S Services, setting the T2S pricing policy and implementing budgetary aspects of T2S. Such technical and operational documentation and records shall be made available, on request, to the authorised representatives of the External Examiner during normal business hours at the relevant Eurosystem offices. The External Examiner may, for its own internal use only, make copies and excerpts from the documentation and records made available by the Eurosystem. Such copies and excerpts shall be listed in a transmission protocol and returned to the Eurosystem on completion of the examination or check and on confirmation from the External Examiner that no other unauthorised copies or transcripts exist; and
  - (c) the External Examiner shall ensure that the authorised representatives who carry out the examinations comply with: (i) internal rules of the relevant Eurosystem member, as communicated to such authorised representatives before the commencement of their activity; and (ii) the confidentiality rules set out in Article 34. The authorised representatives of the External Examiner shall not enter areas or offices and shall not use physical or electronic resources of the Eurosystem other than those which are strictly needed for the performance of the examination.
10. The Eurosystem shall maintain documentation and records documenting the performance of this Agreement, for at least 10 years after their creation and, in respect of documents and records that are maintained at the date of the termination of this Agreement, for at least 10 years following termination. Such documentation and records shall include any financial records relating to costs and expenses directly related to the performance of this Agreement, as incurred by the Eurosystem on its own behalf or on behalf of the [NCB]. In the event that the [NCB] notifies the Eurosystem of a legal action requiring the preservation of certain records or a change in the law establishing longer records preservation periods the Eurosystem shall:
- (i) suspend the destruction of documentation or records, as requested by the [NCB]; and (ii)

## Currency Participation Agreement

---

give the [NCB] 60 calendar days prior notice before destroying the documentation or records subject to such suspension, during which notice period the [NCB] may submit a reasoned request for their further maintenance, with the Eurosystem being entitled to the reimbursement of reasonable costs incurred as a result of such further maintenance.

11. Nothing in paragraph 10 shall relieve the [NCB] or the Eurosystem from their statutory or contractual obligations related to the storage of records and documents.

### Article 25

#### Crisis management

1. The Eurosystem shall manage and resolve any operational disturbances in T2S. In addition, due to the central role which T2S plays in securities settlement in connected markets, the Eurosystem shall assume a coordinating role. In particular, it shall coordinate, initiate and lead activities in connection with any event of an operational or financial nature which may impact the functioning and performance of T2S. The Eurosystem shall use its best efforts to protect the functioning of T2S and to operate T2S in a way that supports the financial stability of all connected markets.
2. The principles of crisis management are laid down in **Schedules 5** and **6**, and the procedural aspects of the crisis management framework are set out in the MOP.
3. The details of the assistance to be provided by the Eurosystem in the case of a crisis are specified in **Schedule 6** and are based on the following principles:
  - (a) the Eurosystem shall have adequate organisational and personnel capacities to deal with a crisis;
  - (b) the Eurosystem shall fully cooperate with the Connected NCBs, the Participating CSDs, the Relevant Competent Authorities and ESMA to manage a crisis, including investigating the feasibility of and implementing reasonable workarounds;
  - (c) the Eurosystem shall prepare and maintain a crisis management plan, and shall test its appropriateness on a regular basis together with the Connected NCBs, the Participating CSDs, the Relevant Competent Authorities and ESMA; and
  - (d) the Eurosystem shall provide a report to the Connected NCBs and the Participating CSDs, the Relevant Competent Authorities and ESMA on the effective handling of a crisis within a reasonable period of time after such a crisis has occurred.
4. The details of the assistance to be provided by the [NCB] in the case of a crisis are specified in **Schedule 6** and are based on the following principles:

## Currency Participation Agreement

---

- (a) the [NCB] shall use its best efforts to fully cooperate with the Eurosystem in order to manage a crisis;
  - (b) the [NCB] shall use its best efforts to inform the Eurosystem about any potential market disturbances that may have an impact on T2S without delay;
  - (c) the [NCB] shall use its best efforts to ensure that its own crisis management plans cover T2S crisis scenarios;
  - (d) the [NCB] shall without undue delay inform and involve its Dedicated Cash Account Holders about any T2S crisis that could impact them; and
  - (e) the [NCB] shall use its best efforts to assist in the preparation and maintenance of a crisis management plan by the Eurosystem.
5. If the [NCB] deems that financial stability of its country or the safeguarding of its currency is threatened, the [NCB] may unilaterally and to the extent possible after informing the Eurosystem reasonably in advance of any such event, invoke its own crisis management plan, which may include the settlement of transactions in [currency] outside T2S, if necessary for reasons of financial stability or the safeguarding of its currency and to the extent the invocation of crisis management measures does not have a negative impact on the settlement of transactions in other currencies in T2S. In such circumstances, the Eurosystem shall, in line with the Decision ECB/2011/20 grant to the Participating CSD(s) designated by the [NCB] a derogation from the eligibility criterion set out in Article 15(1)(e) of the T2S Guideline in relation to such transactions settled outside of T2S to preserve financial stability and to safeguard its currency. The Eurosystem shall use its best efforts to support the [NCB] in moving to crisis management measures and in returning to normal activities in T2S. Without prejudice to the Eurosystem's own crisis management responsibilities, the Eurosystem shall not take action to hinder the efficient crisis management of the [NCB].
6. The Eurosystem shall, to the extent possible, endeavour to: (i) provide reasonable notice prior to the suspension of the provision of T2S Services to a Participating CSD or a Directly Connected Party and (ii) involve the [NCB] in the crisis management in relation to the Participating CSD or a Directly Connected Party as specified in **Schedule 6** and the MOP.

### Article 26

#### Amendments

1. Any amendment of, or supplement to, this Agreement shall be executed in writing and agreed by the Parties unless provided otherwise in this Article. Subject to paragraphs 4 to 6 of this

## Currency Participation Agreement

---

Article, the Parties need to agree on an amendment and neither Party shall unreasonably withhold its agreement to such amendment.

2. Each Party shall inform the other Party of any amendment it proposes to this Agreement as soon as practicable.
3. The Eurosystem may on 30 days' prior notice unilaterally amend this Agreement in respect of non-material amendments of technical or operational nature, such as, changes in contact details of either Party, unless the [NCB], within 30 days following receipt of the notice of any such proposed amendment and subject to confirmation of delivery of the notice by the [NCB], notifies the Eurosystem that it does not agree that the changes are minor.
4. Any amendment to this Agreement required due to a system change pursuant to Article 23 and **Schedule 9** shall be incorporated in this Agreement as soon as practicable. The scope of system changes is further defined in **Schedule 9**.
5. The Eurosystem may amend the Annexes to **Schedule 2** pursuant to the process detailed therein, Furthermore, the Eurosystem may amend **Schedule 7** with prior notice of 180 calendar days to the [NCB], in accordance with the T2S pricing policy decided by the Governing Council and published on the T2S website or if the actual use of T2S Services that have an initial zero price is not within an expected consumption pattern.
6. Without prejudice to either Party's rights and prerogatives, the Parties agree to negotiate in good faith to amend this Agreement to the extent required, in the event that:
  - (a) any of the legal acts or instruments forming an element of the Overall Legal Framework for T2S or for the participation of the [NCB] in T2S, including for the avoidance of doubt such legal acts or instruments that apply in the jurisdiction of the [NCB], is amended and in the event any such amendment has a material effect on this Agreement, in the reasonable opinion of the Eurosystem or the [NCB]; or
  - (b) an objection is received by the Eurosystem in accordance with paragraph 3; or
  - (c) an envisaged amendment to Parallel CPAs, which does not fall under the scope of Article 23 and **Schedule 9**, also necessitates an amendment to this Agreement due to the uniform character of the CPAs and/or the Multilateral Character of T2S; or
  - (d) an envisaged amendment to one or more Framework Agreements with Participating CSDs, which does not fall under the scope of Article 23 and **Schedule 9**, also necessitates an amendment to this Agreement due to the Multilateral Character of T2S.

## CHAPTER 4

### LIABILITY REGIME, COSTS AND NETWORK SERVICE PROVIDER

#### Article 27

##### Standard of liability

1. Except as otherwise provided in this Agreement, the Parties shall be bound by a general duty of reasonable care in relation to each other in performing their respective duties and obligations under this Agreement.
2. Each Party shall be obliged to perform only the duties and obligations specifically attributed to it in this Agreement and shall be liable only in respect of those duties and obligations as provided for in this Agreement.
3. Each Party shall take all reasonable and practical actions or measures to mitigate any loss, damage or adverse consequence that it may cause to the other Party or that it may suffer by reason of the acts or omissions of the other Party.

#### Article 28

##### Liability rules

1. Each Party shall be liable to the other Party without limitation for any loss or damage resulting from fraud or wilful misconduct in performing its duties and obligations under this Agreement.
2. Subject to paragraphs 4 and 6, each Party shall be liable to the other Party for any Direct Loss incurred resulting from its gross or ordinary negligence in performing its duties and obligations under this Agreement. Without prejudice to paragraph 3, liability for indirect loss and damages not qualifying as Direct Loss is excluded to the extent permitted by German law.
3. The Eurosystem shall also be liable to the [NCB] for a claim of the [NCB's] DCA Holder against the [NCB] in connection with T2S Services (hereinafter a 'Customer Claim'), resulting from the Eurosystem's gross or ordinary negligence in performing its duties and obligations under this Agreement, if and to the extent that all of the following criteria are satisfied: (a) the [NCB] is held legally liable for the Customer Claim pursuant to an Enforceable Judgement, or has, with the approval of the Eurosystem (such approval shall not be unreasonably withheld or delayed), settled the Customer Claim; (b) the loss or damage of a DCA Holder is the direct result of an act or omission of the Eurosystem; and (c) the Customer Claim would have been settled by the [NCB] in favour of a DCA Holder according to local market practice. For the avoidance of doubt, the liability under this paragraph shall include

## Currency Participation Agreement

---

claims for loss of interest. If there is a difference between the Customer Claim for which the [NCB] is held liable pursuant to an Enforceable Judgement and the amount due according to local market practice, the Parties shall use their best efforts to settle the issue in an amicable way. The [NCB] shall reimburse to the Eurosystem a Customer Claim (i) for which the condition(s) outlined above are not fulfilled or are reversed or (ii) which is paid twice on the basis of this Agreement as well as on another basis, such as an insurance policy or through a claim paid by a Central Bank based on the same facts and circumstances. For the avoidance of doubt, no Customer Claim shall be paid directly to the NCB's DCA Holders.

4. Each Party shall be liable to the other Party in proportion of the contribution of its fraud, wilful misconduct, gross or ordinary negligence in the loss or damage of the other Party.
5. Without prejudice to paragraph 1, the Eurosystem's liability according to this Article shall be limited or excluded as follows:
  - (a) a maximum total amount per calendar year for all losses and damages suffered by the [NCB] and all Connected NCBs that were caused by events that occurred in the same calendar year;
    - (i) for the Eurosystem's ordinary negligence, the liability of the Eurosystem vis-à-vis, combined, the [NCB] and all Connected NCBs shall be limited to a maximum total amount of EUR 20 000 000 for the relevant calendar year.
    - (ii) for the Eurosystem's gross negligence, the liability of the Eurosystem vis-à-vis, combined, the [NCB] and all Connected NCBs shall be limited to a maximum total amount of EUR 100 000 000 for the relevant calendar year.

If the aggregate amount of losses or damages suffered by the [NCB] and all Connected NCBs in any calendar year exceeds the maximum set out in this subparagraph, then the amount due to the [NCB] shall be calculated and paid by the Eurosystem pro rata, i.e. having regard to the total amount of all losses or damages suffered by the [NCB] and all Connected NCBs;

  - (b) the Eurosystem shall not be liable for losses or damages suffered by the [NCB] related to the early termination of any Parallel CPA or any Framework Agreement by any relevant party; and
  - (c) a Party shall not be liable for any delay in meeting a relevant synchronisation point as specified in **Schedule 2**.
6. Without prejudice to paragraph 1, the [NCB's] liability vis-à-vis the Eurosystem in accordance with this Article shall be limited, in the following way:



## Currency Participation Agreement

---

- (i) for the [NCB's] ordinary negligence, the liability of the [NCB] shall be limited to EUR 2 000 000 per calendar year; and
  - (ii) for the [NCB's] gross negligence, the liability of the [NCB] shall be limited to EUR 10 000 000 per calendar year.
7. The procedures for the exercise, allocation and payment of liability claims are set out in **Schedule 12**.
8. For the avoidance of doubt, the circumstances specified in paragraphs 1 and 2 of Article 30 shall apply as grounds for exclusion of the liability under this Article.
9. As part of the Eurosystem's tasks in accordance with Articles 17, 18 and 22 of the Statute of the ESCB, T2S has the nature of a public service. All obligations of the Eurosystem arising under this Agreement may only be performed jointly by all members of the Eurosystem and qualify as joint liability. All rights and claims of the [NCB] under this Agreement are therefore always rights and/or claims that may be exercised only against all members of the Eurosystem jointly.

### Article 29

#### Indemnification obligations of the [NCB] for acts of Third Parties

1. The [NCB] shall indemnify and hold harmless the Eurosystem from any direct loss incurred as a result of the acts and omissions of one of the [NCB's] DCA Holders in relation to T2S to the extent that such loss is not caused by (i) the Eurosystem's negligence; or (ii) any malfunction or failure in the technical infrastructure of the T2S Business Application to the extent the Eurosystem has not adopted those measures that are reasonably necessary to protect the infrastructure against such malfunction or failure, and in proportion to the Eurosystem's contribution to such loss or damage. The circumstances specified in paragraphs 1 and 2 of Article 30 shall apply as grounds for exclusion of the liability under this Article. In case the Eurosystem and the [NCB] do not agree on the extent and/or proportion of the Eurosystem's contribution to the Eurosystem's loss under sub-paragraphs (i) and (ii), the Dispute Resolution and Escalation Procedure pursuant to Article 37 shall be initiated in order to settle the issue in an amicable way. Any net reimbursement to be paid by the [NCB] to the Eurosystem under this paragraph shall only be due once the dispute has been settled and shall be limited to EUR 10 000 000 per calendar year for all events that occurred in that calendar year. If a dispute under this paragraph cannot be settled pursuant to Article 37, a Party may initiate the court proceedings set out in



## **Currency Participation Agreement**

---

Article 47. The procedures for the exercise and payment of claims of the Eurosystem against the [NCB] under this paragraph are set out in **Schedule 12**.

2. The obligations of the [NCB] pursuant to paragraph 1 shall not be construed as a limitation of any claim for loss or damage the [NCB] may have against the Eurosystem under this Agreement, in particular pursuant to Article 28.
3. To the extent legally feasible under the law applicable to the [NCB], the [NCB] shall procure that its legal and contractual arrangements with a Third Party contain provisions that (i) prevent such Third Parties from asserting a claim directly or indirectly against the Eurosystem in relation to the T2S Services used by the [NCB] and/or (ii) do not provide for a liability regime to such Third Parties which is more favourable than the liability regime applying between the Eurosystem and the NCB under this Agreement.

### **Article 30**

#### **Force Majeure and acts by Third Parties**

1. Each Party shall under no circumstances be obliged to perform or have any liability for its failure to perform any of its duties and obligations under this Agreement to the extent that such failure results from any act, fault, or omission of the other Party or a Third Party for which it is not responsible, or a Force Majeure event.
2. Without prejudice to Article 32, the Eurosystem shall not be responsible for the acts and omissions of communication, network and connectivity service providers, and in particular not for the performance of the Connectivity Services or any performance failures of a T2S Network Service Provider.
3. Each Party shall give notice to the other Party without undue delay upon becoming aware of any actual or imminent failure referred to in paragraph 1, and use its reasonable efforts to resolve such failure as soon as is reasonably possible.

### **Article 31**

#### **Costs and Pricing**

1. Without prejudice to the Change and Release Management procedure and unless otherwise provided in this Agreement, neither Party shall bear any of the costs related to the development of T2S or the rights and obligations under this Agreement which the other Party incurs during the Development Phase and/or the Operational Phase, and the [NCB] shall not bear any of the costs related to the development of T2S or the rights and obligations under this

## Currency Participation Agreement

---

Agreement which the Eurosystem incurs during the Development Phase and/or the Operational Phase.

2. The [NCB] acknowledges that **Schedule 7** shall, to the extent relevant for this Agreement, apply to all T2S Services, including the services provided by the [NCB] to its Dedicated Cash Account Holders in [currency].

### Article 32

#### T2S Network Service Provider

1. The Eurosystem shall allow the [NCB] to connect its IT systems to the T2S Platform, either via a Value-Added Connection or via a Dedicated Link Connection.
2. The [NCB] shall inform the Eurosystem about the solution it has chosen for its connection to T2S at least six months prior to the intended start date of its testing activities.
3. The [NCB] shall use reasonable efforts to ensure that its connectivity with the T2S Platform functions properly at all times. The [NCB] shall provide in its rules or contractual terms for an obligation to be imposed on its Dedicated Cash Account Holders to use reasonable efforts to ensure that their connectivity with the T2S Platform functions properly at all times.
4. The [NCB] shall inform the Eurosystem of its intention to change its T2S Network Service Provider(s) as soon as reasonably possible.
5. As far as the Value-Added Connections are concerned, the following provisions shall apply:
  - (a) The Eurosystem shall communicate to the [NCB] during the Development Phase in accordance with **Schedule 2** which T2S Network Service Provider(s) that it has selected for the provision of Connectivity Services to the [NCB]. The requirements according to which the T2S Network Service Provider(s) have been selected, and which they need to comply with are specified in attachments 1 (technical requirements) and 2 (business requirements) to the Licence Agreement, available on the Banca d'Italia's website. Changes to these requirements shall be managed in accordance with **Schedule 9** and the Licence Agreement.
  - (b) The Eurosystem shall exercise due care in coordinating the Connected NCBs' monitoring of the compliance of the T2S Network Service Provider(s) with those requirements pursuant to sub-paragraph [a] which the [NCB] can monitor itself. The Eurosystem shall exercise due care in the monitoring of the compliance of the T2S Network Service Provider(s) with those requirements pursuant to sub-paragraph [a] which the [NCB] cannot monitor itself. The Eurosystem shall address material breaches of such requirements in accordance with the relevant contractual provisions with the T2S Network Service Pro-

## Currency Participation Agreement

---

viders. If the [NCB] connects to the T2S Platform via a T2S Network Service Provider in respect of which the Eurosystem has identified a material breach or a potential material breach of the requirements, the Eurosystem shall inform the [NCB] about the (potential) material breach it has identified, as well as about the steps it has undertaken to remedy (or avoid) such a (potential) material breach. Should the material breach by the T2S Network Service Provider(s) not be remedied within a reasonable timeframe, the Eurosystem shall take the appropriate measures towards the T2S Network Service Provider(s), subject to the Eurosystem's arrangements with the T2S Network Service Provider(s), and provide support to the [NCB].

- (c) The [NCB] shall carry out its own due assessment as regards the ability of the selected T2S Network Service Provider(s) to offer a Value-Added Connection to the [NCB] and as regards the reliability of these T2S Network Service Provider(s) (financially, operationally, technically or otherwise) towards the [NCB]. The [NCB] may not rely solely on the results of the selection process undertaken by the Eurosystem regarding the selection of the T2S Network Service Provider(s).
- (d) The Eurosystem shall not be responsible for any cost or loss that the [NCB] may incur as a result of a need to transition to a different T2S Network Service Provider, if the T2S Network Service Provider with which the [NCB] has contracted the Connectivity Services loses, for whatever reason, its status as a T2S Network Service Provider.
- (e) For the avoidance of doubt and notwithstanding paragraph 1 of Article 30, the [NCB] shall not be responsible to the Eurosystem for the acts and omissions of its Network Service Provider(s). The [NCB] shall inform the Eurosystem and the other Connected NCBs about any concerns it may have regarding the, financial, operational or technical reliability of the T2S Network Service Provider(s) as well as any performance issues regarding the delivery of the Value-Added Connection provided by its T2S Network Service Provider(s). The Eurosystem shall assess whether or not the information provided by the [NCB] could reasonably indicate non-compliance by the T2S Network Service Provider(s) with the requirements referred to in sub-paragraph a. If the Eurosystem, acting reasonably, decides that the T2S Network Service Provider does not comply with the relevant requirements, the Eurosystem shall forthwith take appropriate steps against the T2S Network Service Provider, subject to the Eurosystem's arrangements with the T2S Network Service Provider. At all times, the Eurosystem shall keep the [NCB] informed of the steps it takes and discuss the proposed actions with the [NCB] in advance.
- (f) The Parties shall monitor the risk situation of the T2S Network Service Provider(s) within their respective contractual relationships with their T2S Network Service Provider(s) and discuss them as appropriate within the Information Security framework.

## Currency Participation Agreement

---

- (g) The Parties shall analyse the impact on the T2S Programme Plan in accordance with **Schedule 2**, whenever the Eurosystem starts a new selection process of a T2S Network Service Provider.
  - (h) The provision of Connectivity Services is outside of the scope of the T2S Services and the Eurosystem is not responsible to the [NCB] for the acts and omissions of the T2S Network Service Provider(s).
6. The Eurosystem shall communicate to the [NCB] in accordance with **Schedule 2** the entity that will offer the necessary Physical Connectivity Services for the Dedicated Link Connection, as well as the necessary specifications for the Value-added Connectivity Services, which the [NCB] has to implement, in order to establish a Dedicated Link Connection with the T2S Platform. The rights and obligations of the Parties related to the Dedicated Link Connection will be specified outside this Agreement.

### CHAPTER 5 INTELLECTUAL PROPERTY RIGHTS, CONFIDENTIALITY AND DATA PROTECTION

#### Article 33 Intellectual Property Rights

1. Each Party and, where applicable, its licensors, shall retain all rights and titles in their Background IPRs. In particular, the Eurosystem shall not acquire any right, title or interest in or to the IPRs of the [NCB] or its licensors (including but not limited to software, data, documentation, processes and procedures of the [NCB]), save to the extent required for the performance of this Agreement.
2. The Parties agree that no IPRs developed or created before or during the course of this Agreement by or for the benefit of the Eurosystem or its subcontractors shall be transferred, licensed or otherwise conveyed to the [NCB], save as expressly set out in this Agreement. This includes without limitation (i) all IPRs developed or created in connection with the development of T2S or the establishing or provision of T2S Services (ii) changes to T2S or to the T2S Scope Defining Set of Documents implemented pursuant to Article 23 and **Schedule 9**, and (iii) the T2S Documentation and any other documents created or used for the development and operations of T2S.

## Currency Participation Agreement

---

3. Notwithstanding paragraph 2 above, the Parties may use general project know-how acquired in connection with T2S, in particular in connection with **Schedule 9**, including after the termination of this Agreement.
4. The Eurosystem shall provide the T2S Services in a manner which shall ensure that no IPR of any Third Party is infringed through the use of T2S Services by the [NCB] in line with this Agreement. If legal action is commenced or threatened against the [NCB] based on an alleged infringement of the IPR of any Third Party through the use of the T2S Services by the [NCB], the [NCB] shall (a) notify the Eurosystem in accordance with Article 44 as soon as reasonably practicable, (b) allow the Eurosystem, at its expense, control of the defence of the claim (without prejudice to the [NCB's] right to take an active role in the proceedings at its own expense); (c) not make admissions, agree to any settlement or otherwise compromise the defence of the claim without the prior written consent of the Eurosystem, such consent not being unreasonably withheld; and (d) give, at the Eurosystem's request, reasonable assistance in connection with the conduct of the defence. If the [NCB] is held liable for the infringement of the Third Party's IPR according to an Enforceable Judgement or has, with the prior written consent of the Eurosystem, settled the claim, the Eurosystem shall reimburse the [NCB] in accordance with **Schedule 12** for all payments that the [NCB] has to make to the relevant Third Party. The consent referred to in the previous sentence shall not be unreasonably withheld. This reimbursement obligation shall not apply with regard to any Third Party claim asserted before a court outside (i) the Union or (ii) the home country of any Connected NCB. In this case, the liability rules pursuant to Article 28 shall apply
5. The Eurosystem grants to the [NCB] a non-exclusive and non-transferable licence to copy the T2S Documentation and any other document made available to the [NCB] for any purpose connected to the use of the T2S Services or other purpose that is incidental to the rights granted to the [NCB] under this Agreement.
6. The T2S Trademarks and Logos remain the sole property of the Eurosystem. The Eurosystem grants to the [NCB] the non-exclusive, non-transferable right to use the T2S Trademarks and Logos in the territories, in which they are protected, for the T2S Services in conformity with applicable law.
7. The [NCB's] trade marks and logos remain its (or its Affiliates') sole property. The [NCB] grants to the Eurosystem the non-exclusive, non-transferable right to use the [NCB's] trade-marks and logos in the territories, in which they are protected, for the T2S Services in conformity with applicable law.

# Currency Participation Agreement

---

## Article 34

### Confidentiality

1. The Parties acknowledge and agree that they have received and will receive Confidential Information in connection with this Agreement.
2. The Parties agree that all Confidential Information shall be used only for the purpose of exercising rights or complying with obligations under this Agreement and the receiving Party shall ensure that only such personnel to whom disclosure of the Confidential Information is required for the purpose of exercising any rights or the performance of the receiving Party's obligations under this Agreement shall have access to the Confidential Information and only to the extent necessary to exercise these rights or perform these obligations.
3. Without prejudice to paragraph 2 and Article 35, to the extent that Confidential Information disclosed by the [NCB] consists of statistical or personal data, such data may only be disclosed by the Eurosystem with the [NCB's] consent. The [NCB] shall cooperate in developing efficient procedures for obtaining this consent both for single and regular use of this data.
4. The receiving Party of each item of Confidential Information shall use all reasonable efforts, taking into account the materiality and proprietary nature of the particular Confidential Information, to protect such Confidential Information from unauthorised use or intentional, inadvertent or otherwise disclosure and, in any event, shall exercise at least the same reasonable level of care to avoid any such unauthorised use or disclosure as it uses to protect its Confidential Information.
5. Notwithstanding the foregoing, a Party may disclose Confidential Information to third parties with the prior written consent of the other Party, and each Party shall be free to disclose Confidential Information without the consent of the other Party:
  - (a) as required by a court of competent jurisdiction or a Relevant Competent Authority or an administrative body of a competent jurisdiction, or otherwise required by applicable laws, but only to the extent legally required; or
  - (b) in any potential or actual litigation among the Parties arising in connection with the T2S Programme, to the extent required to establish, exercise or defend a legal claim; or
  - (c) to their directors, officers, personnel, attorneys, consultants, auditors, subcontractors, insurers and agents on a strict need-to-know basis in connection with their duties, as long as such persons are advised of the confidential nature of such information and their obligation to protect it as confidential and are bound by confidentiality undertakings consistent with those contained in this Agreement, or pursuant to national legislation,

## Currency Participation Agreement

---

provided that, with respect to paragraph (a) above, the Party shall, subject to applicable laws, inform the other Party reasonably in advance in order to enable it to take precautionary actions.

If this Agreement is terminated or expires for any reason, the receiving Party of each item of Confidential Information, including but not limited to documents, contracts, records or properties, shall return it to the disclosing Party and/or, at the disclosing Party's discretion, destroy it and provide a corresponding certificate to the disclosing Party, except to the extent that retention of any Confidential Information is required by applicable laws or expressly permitted under this Agreement. A receiving Party may keep one copy of the Confidential Information for backup, audit and compliance purposes, subject to the obligation to keep this copy confidential and not use the information for any other purpose. The same shall apply where the [NCB] withdraws or is excluded from this Agreement as between the [NCB] and the Eurosystem. This confidentiality obligation shall remain in force following the termination or expiration of this Agreement.

6. Nothing in this Article limits the ability of the Parties to provide the text of this Agreement to the relevant Union institutions and bodies, and national authorities, including the Relevant Competent Authorities, for purposes related to receiving regulatory assessments or approvals necessary for provision and use of the T2S Services or establishing the tax status of the T2S Services, in line with the division of responsibilities in this respect.
7. The Parties acknowledge and agree that this Agreement may be published (including publication on the T2S website) once the Governing Council has approved it and decided to offer this Agreement to Eligible NCBs.

### Article 35

#### Data protection

1. Each Party shall comply with the data protection laws applicable to it and in particular [for EEA NCBs: the relevant transposition of Directive 95/46/EC] [OR] [for non-EEA NCBs: legislation applicable to the [NCB] which is at least equivalent to Directive 95/46/EC] or, as applicable, Regulation (EC) No 45/2001.
2. The Eurosystem shall use personal data solely for the purpose of providing and using the T2S Services. Within these limits, the Eurosystem may transfer personal data to Third Parties including T2S Network Service Providers. Where the Eurosystem receives personal data from the [NCB] under this Agreement, and where the Eurosystem (and/or any of its subcontractors and/or Third Parties used to provide the T2S Services) transfers such personal data to a country outside the European Union which does not provide an adequate level of protection, as the



## **Currency Participation Agreement**

---

level of protection in the European Union, the Parties shall agree on the terms and conditions for the data transfer which shall be based on the standard contractual clauses for the transfer of personal data to processors established in third countries as approved by Decision 2010/87/EU.

3. The [NCB] shall acquaint itself with the respective T2S Network Service Provider's data retrieval policy prior to entering into a contractual relationship with such T2S Network Service Provider. The [NCB] shall, to the extent required under applicable law, have obtained or shall obtain all necessary authorisations and approvals from or shall make the necessary notifications to the relevant regulatory or administrative authorities as well as other interested parties required for the Eurosystem to use and store data as contemplated under this Agreement.

### **CHAPTER 6 MISCELLANEOUS**

#### **Article 36 Governing law**

This Agreement shall be governed by the laws of Germany with the exception of its conflict of laws principles.

#### **Article 37 Dispute Resolution and Escalation Procedure**

1. The Parties shall attempt to resolve disputes between them arising out of or relating to this Agreement in a constructive manner that reflects the concerns and legitimate interests of each Party at the appropriate levels of authority within each Party prior to the initiation of judicial proceedings. In particular, the Parties shall aim to settle a dispute already at the appropriate level and within the appropriate framework with the objective of avoiding the need to invoke this Dispute Resolution and Escalation Procedure.
2. Either Party may initiate the Dispute Resolution and Escalation Procedure by giving written notice to the other Party as specified below, except where a specific dispute resolution procedure is specified in the relevant documentation. It is the expectation of the Parties that each step as follows is completed within a reasonable timeframe:



## Currency Participation Agreement

---

- (a) Step 1: if the parties to the dispute cannot find a mutually agreeable solution to a dispute at working level, a party to the dispute may escalate the issue to the NECSG and the T2S Board;
- (b) Step 2: the NECSG and the T2S Board shall discuss the issue within the respective body. If the dispute has not been resolved and if the initiator belongs to the NECSG, the NECSG may propose to the T2S Board that the dispute is escalated to Step 3(a) or 3(b), or if the initiator belongs to the T2S Board, the T2S Board may propose that the dispute is escalated to Step 3(a) or 3(b);
- (c) Step 3(a): the NECSG shall meet with the chairperson of the T2S Board. In considering the issue, the NECSG may request the advice of the CSG and/or the AG. If the NECSG and the chairperson of the T2S Board come to a mutually agreeable solution, the proposed solution must be submitted to the T2S Board for endorsement. Where the NECSG and the chairperson of the T2S Board have not found a mutually agreeable solution, the issue may be escalated to Step 3(b);

Step 3(b): the T2S Board shall meet with the NECSG member of the Connected NCB(s) in dispute with the Eurosystem or, if deemed appropriate considering the subject-matter of the dispute, with all NECSG members. Following agreement of the parties, one or more expert panels may be established on an ad hoc basis which shall provide advice on technical issues relevant to a dispute. In addition, the T2S Board may seek advice from the CSG and/or the AG. If a mutually agreeable solution cannot be found, the issue may be escalated to the Governors' Forum by any Party without delay;

- (d) Step 4: if a dispute is escalated to the Governors' Forum, it may seek advice of the CSG and/or the AG. Following agreement of the Governors' Forum, one or more expert panels may be established on an ad hoc basis which shall provide advice especially on technical issues relevant to a dispute in order to assist in finding a solution to the dispute. If the Governors' Forum agrees on a solution, the proposed solution must be submitted to the Governing Council and the governing bodies of the respective Connected NCBs for endorsement;
  - (e) Step 5: where despite the Eurosystem's commitment to settle disputes in an amicable way and to facilitate that all Connected NCBs can fulfil their statutory, legal and regulatory responsibilities within the Lean Scope of T2S in a technically viable way, there is an insurmountable obstacle to a consensual solution, the Governing Council and the relevant Connected NCB may terminate the CPA in accordance with the relevant provisions of Article 39.
3. At each stage of the escalation process and without prejudice to the mandate of the Governors' Forum, adequate consideration shall be given to related matters that are the subject of

## Currency Participation Agreement

---

similar escalation procedures between the Eurosystem and a Participating CSD in relation to T2S.

4. The details of the NECSG's mandate are specified in Annex 1 to **Schedule 8**.

### Article 38

#### Governors' Forum

1. The Governors' Forum is mandated to discuss in exceptional circumstances T2S matters relevant to Connected NCBs that could not be resolved through the Dispute Resolution and Escalation Procedure with the objective that the Governors' Forum shall aim at discussing and settling such disputes by agreeing on a common resolution by way of consensus. Any such resolution of the Governors' Forum shall be submitted to the Governing Council for endorsement after the governing bodies of the Connected NCBs concerned have endorsed any such resolution. The details of its mandate are specified in Annex 2 to **Schedule 8**.
2. The Governors' Forum shall be composed of the governors of the Connected NCBs and an equal number of members of the Governing Council.
3. The President of the ECB shall call for a meeting of the Governors' Forum if:
  - (a) one or more members of the NECSG consider that a decision of the T2S Board negatively affects the concerned Connected NCBs ability to safeguard the integrity of the respective currencies, (which includes the implementation of monetary policy including all credit operations as well as the settlement in Central Bank Money in the respective currencies) or financial stability; or
  - (b) one or more governors of the respective Connected NCB(s) wish to discuss any matter in relation to T2S; or
  - (c) the Governing Council wishes to consult the Governor's Forum before taking a decision in relation to T2S or to discuss any matter in relation to T2S.
4. The Eurosystem may reject a Connected NCB's refusal of a Change Request for the following reasons:
  - (a) the need to safeguard the general Eurosystem central bank functions of safeguarding the integrity of the euro or of financial stability or of preventing the distortion of competition between private market participants; or
  - (b) the need to preserve the integrity of T2S for economic, functional or technical reasons.

If the issue has been escalated to the Governors' Forum, where no agreement on an amicable solution of the issue can be found or such a solution is not endorsed by the Governing Coun-

## Currency Participation Agreement

---

cil or the governing body of the Connected NCB concerned, the Connected NCB concerned may terminate this Agreement and may require that it exits within a maximum period of 24 months from the date of the Governing Council's decision to implement the change. The Connected NCB concerned shall endeavour to exit from T2S as soon as reasonably possible already before the expiry of that period. During the exit period and to the extent relevant for the operation of T2S, the Connected NCB shall not be affected by the Change it rejected.

### Article 39

#### Duration, suspension and termination

1. This Agreement shall become effective on the Agreement Date and shall, subject to Article 23 and, Article 26 as well as this Article, continue in full force and effect for an indefinite period of time, unless in the event that T2S as a whole is terminated by the Eurosystem, in which case the Agreement shall be terminated with a minimum notice period of 365 days.
2. The provisions of this Agreement shall not have any retroactive effect except for Article 4, Article 33 and Article 34, which shall apply retroactively.
3. The [NCB] may unilaterally terminate this Agreement with six months' prior notice thereof, unless otherwise agreed in this Agreement or between the Eurosystem and the [NCB]. Without prejudice to paragraph [11] **OR** [10], the [NCB] shall coordinate all exit activities with its Dedicated Cash Account Holders, so that all necessary arrangements are made when the [NCB] will have exited T2S.
4. Each Party may terminate this Agreement:
  - (a) if the other Party is in material breach of any provisions of this Agreement and such breach has not been remedied within 90 calendar days of a written warning notice of such breach with immediate effect; or
  - (b) if the right of termination for cause (*Kündigung aus wichtigem Grund*), which is not covered by sub-paragraph (a), is provided for under mandatory rules of German statutory law with a notice period of 365 days, except where another notice period is provided by applicable law.
5. If due to a major technical threat to the security or integrity of T2S stemming from the [NCB's] technical connection to or use of T2S, the [NCB] remains unable to perform its obligations, and such a threat cannot be resolved by a temporary disconnection of the [NCB] or any of its Dedicated Cash Account Holders in accordance with **Schedule 6**, the Eurosystem may suspend its obligations under this Agreement immediately. The Eurosystem shall also, to the extent possible, give reasonable prior notice to the [NCB] of the planned suspension, and,

## Currency Participation Agreement

---

to the extent possible, consult the [NCB] prior to the planned suspension or provide all relevant information related to the suspension to the [NCB] after the [NCB] has been suspended. A suspension shall be terminated as soon as the reason for suspension has ended.

6. If, due to a Force Majeure event, one of the Parties remains unable to perform its obligations, the other Party may suspend the obligations of this Agreement immediately or, to the extent possible, with reasonable prior notice. Neither Party shall have any liability to the other as a result of such suspension, but any such suspension shall be without prejudice to any rights which may have arisen prior to suspension. A suspension shall be terminated as soon as the reason for suspension has ended.
7. [For non-EEA NCB relevant only: The Eurosystem may terminate this Agreement with reasonable prior notice to the [NCB], where the eligibility conditions for the [currency] pursuant to paragraph (1)(a) of Article 5 are not met and such default is not remedied within a reasonable period of time.]
8. If the [NCB] considers that its rights and obligations under this Agreement would be materially and adversely affected by a change pursuant to Article 23, or such a change would be in conflict with Legal and Regulatory Requirements, and any such change cannot be implemented as a Specific Change, it may with at least 90 calendar days prior notice to the Eurosystem unilaterally terminate this Agreement.
9. Without prejudice to either Party's rights and prerogatives and prior to giving notice to the respective other Party, any request to terminate this Agreement shall be subject to the prior Dispute Resolution and Escalation Procedure with a view to attempting in good faith to reach a resolution to the need for such termination, except if the Parties agree that the Dispute Resolution and Escalation Procedure is unlikely to result in an amicable resolution of the issue or if the [NCB] has renounced its right to resort to the Dispute Resolution and Escalation Procedure.
10. All notices under this Article shall be subject to confirmation of delivery of the notice by the Party receiving the notice.
11. The details of the cooperation and assistance to be provided by the Eurosystem in case of termination are specified in **Schedule 11** and are based on the following principles:
  - (a) the [NCB] shall be responsible for the set up and execution of the exit plan;
  - (b) without prejudice to paragraph 4 of Article 38, if the [NCB] terminates this Agreement pursuant to paragraph 2, until its exit it shall maintain its internal systems sufficiently compatible with the T2S functionality and with agreed Service Levels until its exit, so as to allow T2S to provide the agreed services to other T2S Actors, which may imply that the [NCB] is required to implement authorised changes, in particular in case of Fast-track

## Currency Participation Agreement

---

Changes, as specified in **Schedule 9**. Irrespective of the cause of termination, the [NCB] shall continue to participate in the Change and Release Management procedures until its exit;

(c) irrespective of the cause of termination and subject to paragraph 4 of Article 38, the Eurosystem shall continue to provide T2S Services to the [NCB] for a period of up to 24 months, following the date of the notice of termination on request of the [NCB];

(d) irrespective of the cause of termination, the Eurosystem shall provide the required assistance, as reasonably necessary, to the [NCB] and, except in case of termination for cause by the [NCB], the [NCB] shall reimburse the costs for planning, coordination and execution of exit activities beyond the normal operational support to the Eurosystem; and

(e) the Eurosystem shall maintain at the disposal of the [NCB] the relevant documents, data and archives related to T2S Services provided to the [NCB].

12. To the extent required, the Eurosystem and the [NCB] shall continue to cooperate in good faith on any remaining issues deriving from the [NCB's] participation in T2S

13. [Only for Non-euro Area NCBs of the EU: This Agreement shall expire on the date that the Member State of the Union of the [NCB] adopts the euro.]

### Article 40

#### Own fees and costs

Each Party shall bear its own costs and expenses connected with the preparation, execution, operation and termination of this Agreement, including the costs of its legal and other advisors, without prejudice to other provisions of this Agreement.

### Article 41

#### Entire agreement

Without prejudice to Article 2, this Agreement and the Schedules represent the complete agreement regarding the subject-matter hereof and replace any prior oral or written communications between the Eurosystem and the [NCB].

## Currency Participation Agreement

---

### Article 42

#### No waiver

1. The exercise or waiver, in whole or in part, of any right, remedy, or duty provided for in this Agreement shall not constitute the waiver of any prior, concurrent or subsequent right, remedy, or duty within this Agreement.
2. In relation to disputes between the Parties arising out of or in connection with this Agreement, the [NCB] and the Eurosystem irrevocably and unconditionally waive their respective privileges and immunities in relation to the jurisdiction of the Court of Justice pursuant to Article 47 and irrevocably agree that either Party will not claim any such immunity in proceedings before the Court of Justice. Nothing in or relating to this Agreement shall be deemed to be or shall constitute a waiver of any of the privileges and immunities of the [NCB] or the Eurosystem in relation to immunity from execution or enforcement and attachment or arrest of property.

**OR** [for non-euro area NCBs outside EU opting for jurisdiction of courts of Frankfurt instead of Court of Justice – with corresponding amendment in Article 47]

2. In relation to disputes between the Parties arising out of or in connection with this Agreement, the [NCB] and the Eurosystem irrevocably and unconditionally waive their respective privileges and immunities in relation to the jurisdiction of the courts of Frankfurt am Main pursuant to Article 47 and irrevocably agree that either Party will not claim any such immunity in proceedings before the courts of Frankfurt am Main. Nothing in or relating to this Agreement shall be deemed to be or shall constitute a waiver of any of the privileges and immunities of the [NCB] or the Eurosystem in relation to immunity from execution or enforcement and attachment or arrest of property.

### Article 43

#### Survival

Any terms of this Agreement that by their nature extend beyond the termination or expiration of this Agreement shall remain in effect until fulfilled, including examination, Confidential Information, court proceedings, data protection, governing law and jurisdiction, indemnification, Intellectual Property Rights, limitation of liability, charges and survival.

[*where applicable*: **Schedule 13** shall remain in full force and effect until the end of the calendar year following the calendar year of termination or expiry of this Agreement.]

# Currency Participation Agreement

---

## Article 44

### Notices

1. Except where otherwise provided for in this Agreement, all notices required or permitted pursuant to this Agreement shall be in writing delivered by hand or sent by registered post, facsimile or otherwise or by an authenticated message through a T2S Network Service Provider to the authorised person notified as such by the other Party. Except as otherwise provided for in the MOP, all notices of the [NCB] to the Eurosystem in relation to this Agreement shall be submitted to the Chairperson of the T2S Board and all notices of the Eurosystem to the [NCB] in relation to this Agreement shall be submitted to: [xxx].
2. Except as otherwise provided in this Agreement, to prove that a notice has been sent, it shall be sufficient to prove that the notice was delivered to the relevant address or that the envelope containing such notice was properly addressed and posted except that confirmation of receipt shall be required for notices in relation to Articles [21, 24, 25, 34, 36 and 44] and for all notices in relation to **Schedule 8**.
3. All notices shall be given in English.

## Article 45

### Invalid or incomplete provisions

If a provision of this Agreement is or becomes invalid or is inadvertently incomplete, the validity of the other provisions of this Agreement shall not be affected thereby. The invalid or incomplete provision shall be replaced or supplemented by a legally valid arrangement which is consistent with the intentions of the Parties' intentions or with what would have been the Parties' intention according to the aims of this Agreement had they recognised the invalidity or incompleteness. It is the intention of the Parties that this Article shall not merely result in a reversal of the burden of proof but that Section 139 of the BGB is contracted out in its entirety.

## Article 46

### Subcontracting

1. The [NCB] shall inform the Eurosystem reasonably in advance when it plans to outsource or subcontract any part of its obligations or to assign or transfer any rights or obligations arising out of or in connection with the performance of this Agreement to any Third Party.
2. Due to the public nature of T2S, the operation and running of T2S can only be entrusted to one or more Eurosystem Central Banks. The development and operation of T2S is performed

## Currency Participation Agreement

---

by the 4CB or by an Affiliate of the 4CB or by one or more Euro Area NCBs pertaining to the 4CB, as part of an internal distribution of work within the Eurosystem and is not to be considered as outsourcing, subcontracting, assigning or transferring within the meaning of this Article.

3. Without prejudice to paragraph 2, the Eurosystem may only outsource or subcontract its tasks under this Agreement to a Third Party that have or may have a material impact on the performance of its obligations under this Agreement, if it has the express, prior written consent of the [NCB] which shall not be unreasonably withheld or delayed. No such consent is needed if the Third Party is an Affiliate of one or more of the 4CB and if the rights and obligations of the Parties remain materially unchanged. Outsourcing and subcontracting within the meaning of this Article do not include the procurement of services and/or components necessary for the 4CB to build, upgrade and maintain T2S and the procurement of services by the Eurosystem, and therefore no consent of the [NCB] is needed.
4. Any request for consent under paragraph 3 shall be answered within four weeks after the Eurosystem has received a confirmation of receipt of the request. Any refusal of consent shall give reasons for the refusal. If there is no response within four weeks, the Eurosystem may reiterate its request. The [NCB] shall from that point have two weeks within which to respond to the Eurosystem. If there is no response within these two weeks, the [NCB] shall be deemed to have given its consent.
5. In any case of outsourcing or subcontracting undertaken by a Party, it shall remain liable to the other Party for the performance of its duties and obligations under this Agreement. The Party concerned shall cause its subcontractors to be bound by confidentiality obligations similar to the ones provided by this Agreement.

### Article 47

#### Court proceedings

1. The Parties agree that any dispute between the Parties arising out of or in connection with this Agreement shall be decided through proceedings between all Parties to this Agreement and that any such dispute, subject to the prior completion of the Dispute Resolution and Escalation Procedure set out in Article 37 (except for issues that have undergone the decision-making process in Section 1.2. and 1.3 of **Schedule 8** after which the Dispute Resolution and Escalation Procedure does not have to be initiated) and without prejudice to a Party's termination rights set out in this Agreement, shall be brought before [the Court of Justice of the European Union by either of the Parties] OR [*For Norges Bank and Icelandic CB*] [the courts of Frankfurt].



## Currency Participation Agreement

---

2. The members of the Eurosystem have authorised the European Central Bank to act in the name and on behalf of all other members of the Eurosystem in all matters related to arbitration and court proceedings arising under this Article.

### Article 48

#### Extension to other Parties

The [NCB] shall accept adhesion to this Agreement as Party of any national central bank of a Member State adopting the euro as its currency, provided that any such national central bank confirms in writing that it is bound by the terms of this Agreement as if it had signed this Agreement. The [NCB] shall be given no less than three months' prior written notice of adhesion of any such national central bank to this Agreement, and any such national central bank shall confirm in writing that it is bound by the terms of this Agreement as if it had signed this Agreement.

Done at Frankfurt am Main on [DATE]. The [NCB] and the ECB shall receive one original copy each. Each Eurosystem Central Bank shall receive a certified copy of the original copy deposited at the ECB.

# **CURRENCY PARTICIPATION AGREEMENT**

## **SCHEDULE 1**

### **DEFINITIONS**

## Schedule 1 – Definitions

### 1. Definitions

In this Agreement, unless the context requires otherwise, terms defined in singular have the same meaning in plural, and vice versa.

In this Agreement, references to Union legislation are intended as referring to the most recent version of that legal act.

In this Agreement, unless the context requires otherwise, terms with initial capital letter have the following meanings:

‘4CB’	means the Deutsche Bundesbank, the Banco de España, the Banque de France and the Banca d’Italia, collectively, in their capacity as national central bank [NCBs] responsible for building, maintaining and running the T2S Platform based on the relevant contractual arrangements and on decisions of the Governing Council.
‘Acceptance Tests of T2S’	means that the [NCB] shall have the right to test T2S’ compliance with <b>Schedule 5</b> and the T2S Scope Defining Set of Documents.
‘Advisory Group (AG)’	means the T2S Advisory Group, the mandate and composition of which is set out in the Annex to Guideline ECB/2012/13.
‘Affiliate’	means a legal entity which, with respect to any person, directly, or indirectly through one or more intermediaries, controls, is controlled by or is under common control with the person in question. For the purposes of this definition, ‘control’ means the possession, directly or indirectly, of more than 50% of the equity interests of a person or the power to direct or cause the direction of the management and policies of a person, in whole or in part, whether through ownership of voting interests, by contract or otherwise.
‘Agreement’	means this Currency Participation Agreement, including the Schedules and Annexes.
‘Agreement Date’	means the date on which both Parties signed this Agreement.
‘Annex’	means an Annex to one of the Schedules to this Agreement.
‘Application-to-Application (‘A2A’)	means a connectivity mode to exchange information between the T2S software application and the application(s) at the T2S Actor.
‘Background IPRs’	means all IPRs owned by or licensed to the [NCB] or to the Eurosystem prior to the Agreement Date.

## Schedule 1 – Definitions

‘Basic Custody Services’	means the holding and administration, by an entity entrusted with such tasks, of securities and other financial instruments owned by a Third Party. Basic Custody Services include the safekeeping of securities, the distribution of interest and dividends on the securities in safekeeping, and the processing of corporate actions on the said securities.
‘Batch Settlement’	means the set of sequenced, scheduled processes in T2S that settle or attempt to settle all instructions that are eligible for settlement on an transaction-by-transaction basis.
‘BGB’	means the Bürgerliches Gesetzbuch, i.e., the German Civil Code.
‘Business Continuity and Disaster Recovery’	means the set of rules and procedures aimed at resuming normal T2S Services, in compliance with the Service Levels as described in <b>Schedule 6</b> , after the occurrence of an incident, as well as at mitigating the impact of such an incident.
‘Central Bank (CB)’	means the European Central Bank (ECB), each Euro Area NCB and each Connected NCB.
‘Central Bank Money (CeBM)’	means the liabilities of a Central Bank, in the form of either banknotes or bank deposits held at a Central Bank, which can be used for settlement purposes.
‘Central Bank Static Data’	means the set of business objects, specific to a Central Bank in T2S and owned by that Central Bank, that T2S requires to process the transactional data related to that Central Bank.
‘Central Securities Depository (CSD)’	means an entity that a) enables securities to be established and settled in book entry form, and/or maintains and administers securities on behalf of others through the provision or maintenance of securities accounts; and b) operates or provides for a Securities Settlement System in accordance with Article 2(a) of Directive 98/26/EC or for entities not located in the EEA in accordance with the relevant national legislation equivalent with Directive 98/26/EC and/or that is regulated by Central Bank; and c) is recognised as a CSD by national regulation and/or legislation and/or authorised or regulated as such by the Relevant Competent Authority.
‘CESR/ESCB Recommendations for Securities Settlement Systems’	means the Committee of European Securities Regulators (CESR)/European System of Central Banks (ESCB) Recommendations for Securities Settlement Systems and Recommendations for Central Counterparties in the European Union.
‘Change and Release Management (CRM)’	means the set of rules used and the activities performed when a Change Request as described in, <b>Schedule 9</b> is initiated and until it is rejected or the change is implemented into the production environment.
‘Change Management’	means the processes used and the activities performed when a Change Request as described in, <b>Schedule 9</b> is initiated and until it is rejected or authorised for implementation.

## Schedule 1 – Definitions

‘Change Request’	means a request of a Party for a change that is subject to the Change and Release Management process, as described in <b>Schedule 9</b> .
‘Change Review Group (CRG)’	means the group established by the Steering Level and composed of the relevant T2S Actors mandated to analyse Change Requests and make proposals on the content of T2S releases, as further specified in <b>Schedule 9</b> .
‘Collateral Management System (CMS)’	means a system to manage collateral (i.e. assets, pledged as a guarantee for repayment of loans or sold as part of repurchase agreements) for Central Banks, CSDs and Directly Connected Parties.
‘Collateral Value’	means price of collateral including accrued interest, adjusted with appropriate haircuts and, if applicable, with the pool factor or public index.
‘Common Change’	means a change implemented for the benefit of all T2S Actors as described in <b>Schedule 9</b> .
‘Common Components’	means a set of hardware, software and other technical infrastructure elements available for use by more than one TARGET Service for the purposes of one or more functionalities. In the TARGET2-Securities environment, the Common Components used to deliver the functionalities are indicated in the T2S Operational Governance Process Framework, which is listed in the Annex to Schedule 2 of the FA and CPA as a T2S deliverable.
‘Common Static Data’	means the business information, which is available to all T2S Actors and which T2S requires to process business operations. This includes but is not limited to processing schedules, system entities, the SWIFT BIC Directory, system configuration data, attribute domains that are not specific to a CSD or central bank and standardised roles and privileges from which CSDs and Central Banks can configure their specific roles and access rights for their system users.

Schedule 1 – Definitions

<p>‘Confidential Information’</p>	<p>means any information, data, documentation or material that includes trade and business secrets, know how and information regarding the business, financial situation, products and prospects, processes and methodologies, customers, suppliers and employees, systems, programmes, algorithms, source codes, technical and security requirements and specifications (including any information that any party is obliged to keep confidential according to a contractual agreement or by law), and any other information, data, material or documentation (in each case to the extent marked as confidential or with a similar designation, or which a reasonable person would consider as confidential) related to a Party or its Affiliates, which such a Party has disclosed (in whatever form) to the other Party in connection with this Agreement. Confidential Information does not include information that: (a) has been designated by a Party as being intended for disclosure to Third Parties and does not reveal Confidential Information received by another Party; (b) becomes generally available to the public other than as a result of a breach of the confidentiality obligations under this Agreement; or (c) is received from a Third Party not bound by an obligation of confidentiality with respect to such information (while the receiving Party is aware or made aware by the other Party of this fact); (d) was known to or legally in a Party's possession without obligations of confidentiality prior to such information being provided as Confidential Information in accordance with this Agreement; or (e) is developed by either Party (or its Affiliates or their employees or representatives) independently without the use of Confidential Information of the other Party.</p>
<p>‘Connected NCB’</p>	<p>means an Eligible NCB having signed a CPA.</p>
<p>‘Connectivity Services’</p>	<p>means the combination of Physical Connectivity Services and Value-added Connectivity Services.</p>
<p>‘Crisis’ or ‘Crisis Situation’</p>	<p>means a situation that requires the involvement of the senior manager of the [NCB] (referred to as NCB crisis manager in <b>Schedule 6</b>), in order to manage a severe technical incident or market disturbance, either in accordance with the requirements specified in the MOP or because the procedures described in the MOP are not sufficient to effectively handle the situation.</p>
<p>‘CSD Steering Group (CSG)’</p>	<p>means the T2S governance body which, with respect to a set of matters stipulated in the Framework Agreement, makes resolutions and delivers opinions on behalf of the Contracting CSD and Participating CSDs. The CSG mandate is annexed to <b>Schedule 8</b> of the FA.</p>
<p>‘Currency Participation Agreement (CPA)’</p>	<p>means each of the contractual agreement to be entered into by the Eurosystem and an Eligible NCB to allow for securities settlement in Central Bank Money in the non-euro currency they are responsible for.</p>

Schedule 1 – Definitions

‘Decision (2010/87/EU)’	means Commission Decision 2010/87/EU of 5 February 2010 on standard contractual clauses for the transfer of personal data to processors established in third countries under Directive 95/46/EC of the European Parliament and of the Council (OJ L 39, 12.2.2010, p. 5).
‘Decision ECB/2012/6’	means Decision ECB/2012/6 of 29 March 2012 on the establishment of the TARGET2-Securities Board and repealing Decision ECB/2009/6 (ECB/2009/6) (OJ L 117, 1.5.2012, p. 13).
‘Decision ECB/2011/20’	means Decision ECB/2011/20 of 16 November 2011 establishing detailed rules and procedures for implementing the eligibility criteria for central securities depositories to access TARGET2-Securities services (OJ L 319, 02.12.2011, p. 117).
‘Dedicated Cash Account (DCA)’	means a cash account in T2S operated by a Central Bank.
‘Dedicated Cash Account Holder (DCA Holder)’	means a holder of a DCA which is directly connected to T2S (i.e. through A2A and/or U2A).
‘Dedicated Link Connection’	means a solution to connect the T2S data centres with the data centres of the Directly Connected T2S Actors, whereby the Value-added Connectivity Services are implemented in T2S and in the systems of the Directly Connected T2S Actors.
‘Delivery-versus-Payment (DvP)’	means a securities settlement mechanism which links a securities transfer and a funds transfer in such a way as to ensure that delivery occurs if – and only if – the corresponding payment occurs.
‘Development Phase’	means the period, during which the Eurosystem specifies, develops and tests T2S and establishes its operational framework; this period ends on the date that the Governing Council decides that the full scope of T2S Services as documented in <b>Schedule 5</b> are operational in the T2S production environment, as depicted in Annex 1 to <b>Schedule 1</b> .
‘Directive 95/46/EC’	means Directive 95/46/EC of the European Parliament and of the Council of 24 October 1995 on the protection of individuals with regard to the processing of personal data and on the free movement of such data (OJ L 281, 23.11.1995, p. 31).
‘Directive 98/26/EC’	means Directive 98/26/EC of the European Parliament and of the Council of 19 May 1998 on settlement finality in payment and securities settlement systems (OJ L166, 11.6.1998, p. 45).
‘Direct Loss’	means loss or damage directly caused to the damaged Party as a result of the gross or ordinary negligence of the other Party in performing its duties and obligations under this Agreement. Lost revenues, lost profits, lost savings and reputational damage shall not qualify as Direct Loss, instead they shall qualify as indirect losses.

## Schedule 1 – Definitions

‘Directly Connected Party (DCP)’	means a T2S User, which has been authorised by its Contracting CSD or Central Bank to access T2S directly to use T2S Services (e.g. directly connected DCA Holder).
‘Directly Connected T2S Actor’	means either any of the Participating CSDs, or any of the Connected NCBs, or any of the DCPs or directly connected DCA Holders.
‘Dispute Resolution and Escalation Procedure’	means the procedure described in Article 37] of this Agreement for resolving disputes between the Parties.
‘Dynamic Data’	see ‘Transactional Data’.
‘ECB’	means the European Central Bank.
‘Eligible NCB’	means (i) each Non-euro Area NCB, and (ii) each Other Central Bank from the country belonging to the European Economic Area, or from another country in the case where it is deemed eligible pursuant to the Governing Council decision referred to in recital F of the Currency Participation Agreement.
‘Enforceable Judgement’	means a binding and enforceable judgment or equivalent type of decision rendered by a court or award rendered by an arbitral tribunal
‘ESMA’	means European Securities and Markets Authority
‘Euro Area NCB’	means the NCB of a Union Member State whose currency is the euro.
‘Eurosistem’	means, in accordance with Article 1 of the Statute of the ESCB and of the European Central Bank, the ECB and the NCBs of the Union Member States whose currency is the euro..
‘Eurosistem Acceptance Testing (EAT)’	means the formal testing conducted by the Eurosistem to determine whether the T2S Platform is compliant with the T2S Scope Defining Set of Documents.
‘Eurosistem Central Bank’	means either the ECB or the Euro Area NCB, as the case may be.
‘Exit Management’	means a set of rules and procedures applied on termination of the Agreement, howsoever caused, as described in <b>Schedule 11</b> .
‘External Examiner’	means a well-reputed, internationally active auditing firm that has the tasks set out in Article 24 of this Agreement assigned to it.
‘Fast-track Change’	means a change that is imposed by Legal and Regulatory Requirements, or by CSG resolutions related to risk management, or changes that are critical for the stability of the T2S Platform or by Central Bank decisions related to safeguarding the currency/-ies or related to crisis management measures to ensure financial stability and that, owing to the time constraints, has to be implemented in a shorter timeframe than normal, which will be decided on an ad-hoc basis, as specified in <b>Schedule 9</b> .



## Schedule 1 – Definitions

‘Force Majeure’	means any circumstances beyond the reasonable control of the non-performing Party, including, without limitation, an element of nature or an act of God, earthquake, fire, flood, war, terrorism, civil, industrial or military disturbance, sabotage, labour strike or lock-outs, pandemic, epidemic, riot, loss or malfunction of utilities or communication services, court order, act of civil or military authority, or governmental, judicial or regulatory action.
‘Framework Agreement (FA)’	means the contractual framework between a CSD and the Eurosystem for the Development Phase and the Operational Phase of T2S.
‘Free of Payment (FoP)’	means the delivery of securities with no corresponding payment.
‘General Specifications (GS)’	means together with the GFS and the GTD, the document that describes how the Eurosystem envisages implementing the URD. In particular, the General Specifications focus on those user requirements that do not have a functional or technical dimension, such as operational support, testing, migration and Information Security.
‘General Functional Specifications (GFS)’	means a general functional description of the T2S Business Application to be developed to comply with the URD. It will include elements such as the functional architecture (domains, modules and interactions), the conceptual models, the data model or the data flow process.
‘General Principles of T2S’	means the general principles approved by the Governing Council to define the main cornerstones of T2S, as referenced to in the URD.
‘General Technical Design (GTD)’	means the document that details the solution envisaged for the T2S non-functional requirements, more specifically with regard to the application design and the infrastructure design
‘Governors’ Forum’	has the meaning set out in Article 38 and <b>Schedule 8</b> .
‘Governance’	means the set of rules and procedures concerning the management of T2S Services, including the related decision-making of the parties involved in T2S, as specified in <b>Schedule 8</b> .
‘Governance Bodies’	means the bodies specified in Article [21 (6)] of this Agreement and involved in the decision-making process with final decisions being taken by the Governing Council in accordance with Article [21] of this Agreement and in accordance with <b>Schedule 8</b> .
‘Governing Council’	means the decision-making body of the ECB comprising the members of the Executive Board of the ECB and the governors of the Euro Area NCBs, as provided for in Article 10 of the Statute of the ESCB.
‘Graphical User Interface (GUI)’	means the interface that allows a user to interact with a software application through the use of graphical elements (e.g. windows, menus, buttons and icons) on a computer screen using the keyboard and the mouse.

Schedule 1 – Definitions

‘Guideline ECB/2012/13’	means Guideline ECB/2012/13 of 18 July 2012 on TARGET2-Securities (OJ L 215, 11.8.2012, p. 19), and repealing Guideline ECB/2010/2.
‘Information Security’	means a set of requirements and procedures, described in <b>Schedule 10</b> and based on International Organisation for Standardisation (‘ISO’) Standard 27002:2013, as the latter is amended or replaced from time to time, aimed at safeguarding the integrity, confidentiality and availability of the T2S information and T2S Services.
‘Information Technology Infrastructure Library (ITIL)’	means the set of best practices for managing IT infrastructure, development and operations, maintained under the auspices of the Office of Government Commerce, an office of the UK Treasury.
‘Insolvency Event’	means a collective judicial or administrative proceeding, including an interim proceeding, in which the assets and affairs of the Contracting CSD are subject to control or supervision by a court or other competent authority for the purpose of reorganisation or liquidation.
‘Intellectual Property Rights (IPRs)’	means any patents, utility models, designs, trademarks, copyrights (each of the foregoing, to the extent applicable, registered, applied for or unregistered), inventions whether or not patentable, database rights, know-how and all rights having equivalent or similar effect in any jurisdiction.
‘Intended Settlement Date (ISD)’	means the date on which the parties to a securities transaction agree that settlement is to take place. The ISD is also referred to as the contractual settlement date or value date.
‘International Securities Identification Number (‘ISIN’)	means the number, which uniquely identifies a security. Its structure is defined in ISO 6166.
‘Investor CSD’	means a CSD that holds a security for which it is not the/an Issuer CSD. It holds these securities either directly or indirectly, via one or more intermediaries, at the/an Issuer CSD
‘Issuer CSD’	means a CSD, which holds a primary deposit in the relevant securities, either in dematerialised or physical form.
‘Key Performance Indicator(s) (KPI(s))’	means a metric used to quantify the expected performance of the Eurosystem and to monitor compliance with the Service Level Agreement.
‘Lean Scope of T2S’	means the scope of T2S defined by the URD resulting from the market involvement and is restricted by the General Principles of T2S, as referenced in the URD.
‘Legal and Regulatory Requirements’	means all applicable requirements (as may be amended from time to time) that a Connected NCB must comply with, including those of a legal, regulatory (including fiscal), supervisory and oversight nature and that are relevant in the context of T2S.

## Schedule 1 – Definitions

‘Licence Agreement’	means the contract signed by the Banca d'Italia, in the name and on behalf of the Eurosystem, and each NSP, which contains the requirements which the latter has to fulfil to be entitled to deliver the Connectivity Services to the Eurosystem and to the Directly Connected T2S Actors.
‘Maintenance Window’	means the period for system maintenance, during which T2S is planned to be unavailable, as defined in <b>Schedule 6</b> .
‘Manual of Operational Procedures (MOP)’	means the document that describes the procedures to be applied by all T2S Actors, aimed at ensuring the smooth conduct of daily operations and at minimizing the duration and impact of service interruptions or deteriorations.
‘Matching’	means the process used for comparing the settlement details provided by parties in order to ensure that they agree on the terms of the transaction.
‘Member State’	means a country that is a member of the Union.
‘Migration’	means a set of rules and procedures concerning the [NCB’s] migration to T2S, as described in <b>Schedule 4</b> .
‘Migration Period’	means the time period beginning on the date on which the T2S Board confirms that the T2S production environment is ready for CSDs and Central Banks to connect (SP14.1 – Ready to connect to Production (Wave 1)) and ending on the date on which [all CSDs and Central Banks] that have signed the FA and the CPA, respectively, have migrated to T2S.
‘Multilateral Character of T2S’	has the meaning set out in Article [3] of this Agreement.
‘National User Group (NUG)’	has the meaning set out in the Annex to the T2S Guideline and link the respective national market with the AG.
‘ <i>NCB-specific Requirements</i> ’	<i>means features affecting the design, functionality and/or operational or legal requirements of T2S or Legal and Regulatory Requirements, that are specific to the [NCB] and that are described in <b>Schedule 13</b>.</i>
‘NCBs’ Acceptance Tests of the T2S Services’	means the process whereby the Connected NCB assesses the compliance of the relevant T2S Services with <b>Schedule 5</b> and the T2S Scope Defining Set of Documents as further specified in Article [13] of this Agreement and in <b>Schedule 3</b> .
‘Non-euro Currencies Steering Group (NECSG)’	means the T2S governance body which, with respect of a set of matters stipulated in the CPA, makes resolutions and delivers opinions on behalf of the non-euro area NCBs having signed the CPA. The NECSG mandate is annexed to <b>Schedule 8</b> of the CPA.
‘Non-euro Area NCB’	means the NCB of a Union Member State, whose currency is not the euro.

## Schedule 1 – Definitions

‘Operations Managers Group (OMG)’	means the group established by the Steering Level and composed of the relevant T2S Actors that develops and maintains the Manual of Operational Procedures, meets to review the T2S service performance against the Service Level Agreement and coordinates the management of operational incidents, as specified in Schedule 6.
‘Operational Phase’	means the time period when the full scope of T2S Services are operational in the T2S production environment and beginning on the T2S Go-Live Date, as depicted in Annex 1 to <b>Schedule 1</b> .
‘Other Central Bank’	means the Central Bank of a country outside the EU.
‘Other T2S Specification Documents’	means the set of documents, when added to the T2S Scope Defining Set of Documents, that provide a full description of T2S. This includes the GFS non-Functional Chapters.
‘Parallel Currency Participation Agreement’	means an agreement essentially identical, save for the identity of the Parties, to this Agreement, entered into between a Connected NCB (other than the [NCB]) and the Eurosystem.
‘Participating CSD(s)’	means the CSD(s) that have signed the Framework Agreement.
‘Party’ or ‘Parties’	means the Connected NCB and the Eurosystem or either of them (as required by context).
‘Payment Bank’	means a commercial bank used to affect money settlements. In the context of securities settlement, a Payment Bank provides cash on behalf of a CSD participant to support the settlement of securities.
‘Payment Free of Delivery (PFoD)’	means a transfer of cash without the delivery of securities.
‘Physical Connectivity Services’	means the implementing, maintaining and keeping available of a data communication network for the purpose of exchanging files and messages between the Directly Connected T2S Actors and T2S, as more specifically described in the Licence Agreement.
‘Pricing’	means a set of rules and procedures that is applied to price the T2S Services and T2S-related services provided by the Eurosystem, as described in <b>Schedule 7</b> .
‘Project Managers Group (PMG)’	means the group established by the Steering Level and composed of the relevant T2S Actors that coordinates and monitors activities to ensure that the initial release as well as subsequent releases of T2S go live, as specified in <b>Schedule 2, 3 and 4</b> .
‘Real-time Settlement’	means the continuous process in T2S that settles or attempts to settle instructions that are eligible for settlement on a transaction-by-transaction basis.

## Schedule 1 – Definitions

‘Regulation (EC) No 45/2001’	means Regulation (EC) No 45/2001 of the European Parliament and of the Council of 18 December 2000 on the protection of individuals with regard to the processing of personal data by the Community institutions and bodies and on the free movement of such data (OJ L 8, 12.1.2001, p. 1).
‘Regulation (EU) No 909/2014’	means Regulation (EU) No 909/2014 of the European Parliament and of the Council of 23 July 2014 on improving securities settlement in the European Union and on central securities depositories and amending Directives 98/26/EC and 2014/65/EU and Regulation (EU) No 236/2012 (OJ L 257, 28.8.2014, p. 1), also referred to as ‘CSDR’.
‘Release Management’	means the set of rules used and the activities performed to implement a set of authorised changes and defect corrections in a new version of the T2S Business Application, as set out in <b>Schedule 9</b> .
‘Relevant Competent Authority’	means any organisation having regulatory, supervisory or oversight authority over the [NCB], or a Connected NCB or a Participating CSD (as required by the context).
‘RTGS Participants’	means participants in the RTGS System that are considered as participants according to the national implementation of Article 2 of Settlement Finality Directive [OR <i>if the NCB is established outside the European Economic Area</i> : participants in the [NCB’s] RTGS System that enjoy an equivalent protection to that in force for ‘participants’ as defined in Article 2 of the Settlement Finality Directive].
‘RTGS System’	means a Real-Time Gross Settlement System operated by the [NCB] or by another Central Bank (as required by the context) which is connected to T2S to provide liquidity in [currency] to T2S.
‘Schedule’	means a Schedule to this Agreement.
‘Second T2S Protocol’	means the protocol signed by all Eurosystem CBs the purpose of which is for the Eurosystem CBs to grant each other a power of attorney to sign the Framework Agreement with the CSDs in the name and on behalf of all the Eurosystem CBs.
‘Securities Account’	means an account maintained by a CSD to which securities may be credited or debited.
‘Securities Reference Data’	means the business information for a financial instrument, excluding any CSD-specific attributes, that is under the responsibility of the SME and available to all Participating CSDs, that T2S stores and requires for processing settlement instructions-related operations, including the calculation of cash penalties in the context of the T2S Penalty Mechanism service.

## Schedule 1 – Definitions

‘Securities Settlement System’	means a system as defined in Article 2(a) of Directive 98/26/EC for the execution of transfer orders related to title to or interest in a security or securities by means of a book entry on a register, or otherwise.
‘Service Description’	means the description of the T2S Services, contained in <b>Schedule 5</b> .
‘Service Level’	means level of performance of a T2S Service that <b>Schedule 6</b> and that the Contracting CSD requires to deliver its services to its customers.
‘Service Level Agreement (SLA)’	means the agreement defining the Service Levels, measured against agreed KPIs where relevant, to be provided by the Eurosystem to the Connected NCBs, as specified in <b>Schedule 6</b> and in relation to T2S Services.
‘Service Level Report’	means the monthly report made available by the Eurosystem to the [NCB] to determine the degree of the Eurosystem’s compliance with the Service Level Agreement, as specified in <b>Schedule 6</b> , in particular as regards the KPIs.
‘Settlement Day’	means a day on which T2S settlement takes place according to the daily processing schedule.
‘Settlement Finality Directive’	means Directive 98/26/EC of the European Parliament and of the Council of 19 May 1998 on settlement finality in payment and securities settlement systems (OJ L 166, 11.6.1998, p. 45).
‘Specific Change’	means any new feature, functionality or service – or any amendment of an existing feature, functionality or service – which is not implemented as a Common Change (within the applicable governance arrangements), but which some Participating CSDs and/or Central Banks wish to implement, provided that it is compliant with the Lean Scope of T2S, and for which they jointly accept to bear the investment and running costs.
‘Statute of the ESCB’	means the Statute of the European System of Central Banks and of the European Central Bank (Protocol No 4 to the Treaty on the Functioning of the European Union, OJ C 83, 30.3.2010, p. 230).
‘Steering Level’	means the level comprising the T2S Board for tasks delegated by the Governing Council, the NECSG and the CSG, as specified in <b>Schedule 8</b> .
‘Suspension’	means the temporary freezing – possibly limited to the T2S Services relevant to the cause of suspension – of the rights and obligations of the Contracting [NCB] for a period of time to be determined by the Eurosystem, as described in Article [39].

Schedule 1 – Definitions

‘T2S Actor’	means either the Participating CSDs, a CSD participant (a legal entity or, as the case may be, an individual) having a contractual relationship with the CSD for the processing of its securities settlement-related activities in T2S, or a Central Bank, whose currency is available for settlement-related processing in T2S, or a member of a Central Bank having a contractual relationship with the Central Bank for the processing of its settlement-related cash-processing activities in T2S.
‘T2S Board’	means the Eurosystem management body established pursuant to Decision ECB/2012/6, which has the task of developing proposals for the Governing Council on key strategic issues and executing tasks of a purely technical nature in relation to T2S.
‘T2S Business Application’	means the software developed and operated by the 4CB on behalf of the Eurosystem with a view to enabling the Eurosystem to provide the T2S Services on the T2S Platform.
‘T2S Documentation’	means the T2S non-scope defining set of documents that consists of the other T2S Specification Documents, the T2S Operational Phase Documents and the T2S Project Documents as described in <b>Schedule 2</b> Annex 8 (T2S Deliverables List and Management Process).
‘T2S-Enabled Services’	means the services of the [NCB] it provides to its Dedicated Cash Account Holders on the basis of the T2S Services.
‘T2S Go-Live Date’	means the first Settlement Day after which the first Participating CSD(s)/NCB(s) have migrated to T2S.
‘T2S Memorandum of Understanding’	means the Memorandum of Understanding concluded on 16 July 2009 between the Eurosystem and the Contracting CSDs as well as other European CSDs, showing the commitment towards T2S and setting out the mutual obligations and responsibilities for the time period up to the conclusion of a definitive agreement.
‘T2S Network Service Provider (T2S NSP)’	means a network service provider (NSP) that has concluded a Licence Agreement with the Eurosystem to provide Connectivity Services to T2S. It is a business or organisation providing the technical infrastructure, including hardware and software, to establish a secure and encrypted network connection that permits the exchange of information between T2S and T2S Actors.
‘T2S Operator’	means the legal and/or organisational entity/entities that operate/operates the T2S Platform. As part of an internal distribution of work within the Eurosystem, the Governing Council entrusted the 4CB with operating T2S, on behalf of the Eurosystem.

## Schedule 1 – Definitions

‘T2S Operational Phase Documents’	means the set of documents that describes how T2S provides its services when it is in production. It encompasses the documentation for T2S as a software application and the manuals describing the rules and procedures for operating T2S.
‘T2S Platform’ or ‘TARGET2-Securities (T2S)’	see ‘TARGET2-Securities (T2S)’.
‘T2S Programme’	means the set of related activities and deliverables needed to develop T2S until the full Migration of all CSDs, which have signed the Framework Agreement and all Euro Area NCBS as well as all Connected NCBS.
‘T2S Programme Plan’	means the common Eurosystem-CSD-Central Bank plan, outlining the milestones, Key Milestones and timelines to deliver the T2S Programme as well as the respective actions and contributions required from the Eurosystem, the CSDs and other T2S Stakeholders, as described in <b>Schedule 2</b> .
‘T2S Project Documents’	means the set of documents required for planning, monitoring and successfully completing the scheduled activities (e.g. User Testing, Migration, client readiness tracking) in the T2S project lifecycle but not during the operational part, i.e. from the start of the T2S Programme until T2S is live, or during any subsequent preparation for releases.
‘T2S Scope Defining Set of Documents’	means the set of documents defining the scope of T2S composed of the URD, the UDFS, the GUI Business Functionality, the GFS Functional Chapter, the Data Migration Tool Requirements and Related Procedures and the Data Migration Tool File Specifications.
‘T2S Services’	means the services to be provided by the Eurosystem to the Contracting CSDs and Central Banks as specified in this Agreement and any other relevant agreement.
‘T2S Stakeholder’	means any organisation; legal entity or governmental entity; public or private interest groups; or individual that has a valid interest in the outcome of the T2S project and the governance and operation of T2S.
‘T2S Threat Catalogue’	means the information on relevant threats to the T2S Platform,, which serves as the basis for the specification of appropriate security controls and, at a later stage, the evaluation of residual risks in terms of impact and likelihood, as described in <b>Schedule 10</b> (Information Security).
‘T2S Trademarks and Logo’	means all “T2S”-trademarks and / or the logo  owned by a Eurosystem Central Bank.
‘T2S User’ or ‘User’	see ‘User’
‘TARGET2’	means the payment system functioning in accordance with Guideline ECB/2012/27 of 5 December 2012 on a Trans-European Automated Real-time Gross settlement Express Transfer system (TARGET2) (OJ L 30, 30.1.2013, p. 1).



## Schedule 1 – Definitions

‘TARGET2-Securities (T2S)’ or ‘T2S Platform’	means the set of hardware, software and other technical infrastructure components through which the Eurosystem provides the services to CSDs that allow core, neutral and borderless settlement of securities transactions on DvP basis in Central Bank Money.
‘Third Party’	means an individual or legal entity, which is not party to the contractual relationship, as defined in this Agreement. For the avoidance of doubt, a Third Party is a person or legal entity other than the [NCB], the European Central Bank, Euro Area NCB or the T2S Operator.
‘Transactional Data’	means the information that T2S creates and stores through the execution of a business process event where the content of the information defines that event. This includes but is not limited to inbound and outbound XML messages, all types of settlement instructions and all data that T2S generates for the life cycle of the instruction (e.g. securities positions) and static data maintenance instructions. This is also referred to as Dynamic Data in the Schedules and in other documentation.
‘Transfer Order’	has the meaning set out in Article 2(i) of Directive 98/26/CE.
‘Treaty on the Functioning of the European Union (TFEU)’ or ‘Treaty’	means the Treaty on the Functioning of the European Union (OJ C 83, 30.3.2010, p. 47).
‘User’ or ‘T2S User’	means a legal entity or, as the case may be, an individual, that has a contractual relationship with the Contracting CSD or another Participating CSD for the processing of its settlement-related activities in T2S, or a member of a CB (whose currency is available for settlement-related processing in T2S) having a contractual relationship with the CB for the processing of its securities settlement-related cash-processing activities in T2S.
‘User Detailed Functional Specifications (UDFS)’	means the a detailed description of the functions managing the T2S external data flows (from A2A). It will include the necessary information for the users to adjust or to develop their internal information systems with a view to connecting them to T2S.
‘User Handbook (UHB)’	means the document describing the way in which T2S Users can make use of a number of T2S software functions that are available in a U2A (screen- based) mode
‘User Requirements Document (URD)’	means document setting out the user requirements for T2S as published by the ECB on 3 July 2008 and as subsequently amended through the T2S change and release management procedure.
‘User Testing ‘ or ‘User Tests’	means a set of rules and procedures concerning the T2S’s testing by the Connected NCBs as described in <b>Schedule 3</b> .
‘User-to-Application (U2A)’	means a connectivity mode to exchange information between software applications of T2S and a T2S Actor through the GUI.

**Schedule 1 – Definitions**

---

'Value-added Connection'	means a solution to connect the T2S data centres with the data centres of the Directly Connected T2S Actors, whereby both the Value-added Connectivity Services and the Physical Connectivity Services are provided by a NSP.
'Value-added Connectivity Services'	means the set of messaging services, security services and operational services either provided by an NSP in accordance with the Licence Agreement, or implemented in T2S and in the systems of the Directly Connected T2S Actors.

**Annex 1 – Diagram of Phases/Periods**

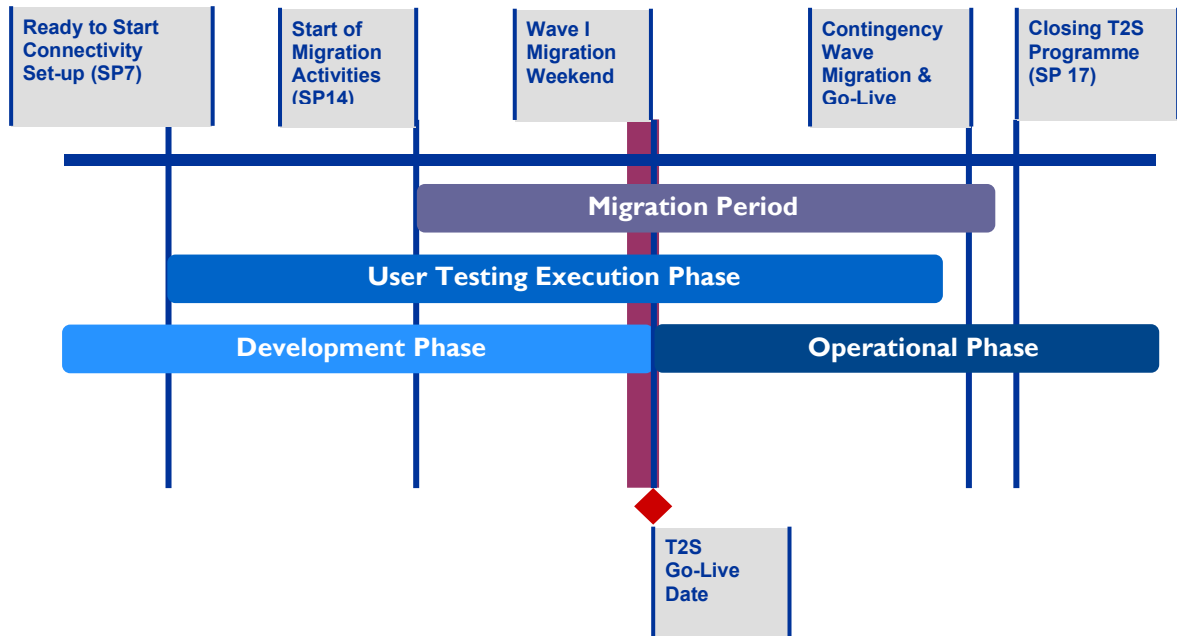

# **CURRENCY PARTICIPATION AGREEMENT**

## **SCHEDULE 2**

### **T2S PROGRAMME PLANNING AND MONITORING**

# Currency Participation Agreement

## Schedule 2 – T2S Programme Planning and Monitoring

---

### Table of contents

<b>1</b>	<b>INTRODUCTION.....</b>	<b>1</b>
1.1	Context.....	1
1.2	Structure of Schedule.....	2
<b>2</b>	<b>SCOPE AND OBJECTIVES.....</b>	<b>4</b>
2.1	Scope.....	4
2.2	Objectives .....	4
<b>3</b>	<b>GENERAL RESPONSIBILITIES OF THE PARTIES TO THIS AGREEMENT... </b>	<b>5</b>
3.1	General Responsibilities of the Eurosystem .....	5
3.2	General Responsibilities of the Contracting National Central Banks (CBs).....	5
3.3	General responsibilities of the Project Manager Group (PMG).....	7
<b>4</b>	<b>SUPPORTING DOCUMENTATION.....</b>	<b>8</b>
4.1	T2S Programme Work Breakdown Structure .....	8
4.2	T2S Programme Deliverables .....	8
4.3	Milestones .....	9
<b>5</b>	<b>T2S PROGRAMME PLAN.....</b>	<b>10</b>
5.1	CB-relevance of planning items.....	10
5.2	T2S Programme Plan Views .....	11
5.3	T2S Critical Path.....	14
<b>6</b>	<b>MONITORING FRAMEWORKS.....</b>	<b>15</b>
6.1	T2S Programme Status Assessment Framework .....	15
6.2	T2S Risk and Issue Management and Monitoring Framework.....	17
6.3	T2S Monitoring of Client Readiness Framework .....	22
<b>7</b>	<b>PROCESSES.....</b>	<b>27</b>
7.1	Methodology and Conventions .....	27
7.2	Programme Plan Preparation, Adaptation and Assessment Review Process.....	29
7.3	Adaptation Process for updated Annexes without affecting the plan: .....	32
7.4	Disagreement Resolution process .....	34

# Currency Participation Agreement

## Schedule 2 – T2S Programme Planning and Monitoring

---

### 1 **1 Introduction**

#### 2 **1.1 Context**

3 T2S is a large-scale programme, involving a significant number of actors. Owing to this  
4 complexity, a successful development, implementation and production start of T2S requires  
5 agreement between the parties to this Agreement on their roles and responsibilities as well as the  
6 respective expectations and commitments during the programme. It is not sufficient for the parties  
7 to this Agreement to the T2S Programme to establish and monitor stand-alone project plans  
8 independently of each other. It requires a common programme plan that:

- 9     ▪ is based upon clearly identified and scoped deliverables;
- 10    ▪ takes into account all the respective constraints and dependencies of the parties to this  
11      Agreement; and
- 12    ▪ undergoes regular, close monitoring over the life of the programme, with decisions  
13      committing all parties.

14 As the plan may evolve during the course of the T2S Programme, a comprehensive framework  
15 must exist to manage events that may affect the programme's deliverables and milestones,  
16 including a review and decision-making process for adapting the programme plan. This requires a  
17 regular dialogue between the parties to this Agreement to enable them to manage their own parts  
18 of the programme, and jointly make proposals on common tasks and activities affecting the other  
19 parties to this Agreement. Contracting National Central Banks (CBs) must be in the position to  
20 organise their planning and their internal resources. Conversely, the Eurosystem planning of the  
21 User Testing and Migration phases, as well as the start operations in T2S, requires the input of all  
22 T2S Actors.

23 A successful programme delivery requires a consistent and complete framework to plan,  
24 coordinate, monitor and report the activities of the T2S Actors. Article 25 of the CPA defines the  
25 process of updating this Schedule 2. This Schedule 2 specifies the process of updating Annexes of  
26 Schedule 2 (see Section 7).

27

# Currency Participation Agreement

## Schedule 2 – T2S Programme Planning and Monitoring

---

### 28 1.2 Structure of Schedule

29 The Schedule 2 contains different sections and has several Annexes.

30 The third section presents the general responsibilities of the Eurosystem and the Contracting CBs.

31 The fourth section describes the main documents supporting the monitoring of the T2S  
32 Programme Plan.

33 The fifth section presents the three official views of the T2S Programme plan and their main  
34 features.

35 The sixth section presents the main principles and conventions used for progress monitoring, for  
36 risk monitoring and for the management of bilateral relations between the Eurosystem and each  
37 Contracting CB.

38 The seventh section documents the T2S Programme Plan monitoring process and includes the  
39 process for changing Schedule 2 Annexes.

40 The Annexes to Schedule 2 have three objectives:

- 41 ▪ to provide the initial state of the T2S Programme planning documentation, which may evolve  
42 according to the processes defined in Schedule 2;
- 43 ▪ to provide the templates used for programme reporting purposes; and
- 44 ▪ to provide the initial state of the supporting documentation.

45 Schedule 2 includes the following Annexes:

#### 46 Annexes with focus on the plan substance:

- 47 ▪ Annex 1 - T2S Executive Summary Plan
- 48 ▪ Annex 2 - T2S Operational Plan
- 49 ▪ Annex 3 - T2S Detailed Plan
- 50 ▪ Annex 4 - T2S Programme Plan assumptions

#### 51 Annexes with focus on reporting templates:

- 52 ▪ Annex 5 - T2S Programme Progress Reporting templates
- 53 ▪ Annex 6 - T2S Risk and Issue Reporting templates

# Currency Participation Agreement

## Schedule 2 – T2S Programme Planning and Monitoring

---

- 54 Annexes with focus on supporting documents:
- 55   ▪ Annex 7 - T2S Programme Work Breakdown Structure (WBS)
- 56   ▪ Annex 8 - T2S list of Deliverables
- 57   ▪ Annex 9 - T2S list of Synchronisation points
- 58   ▪ Annex 10 - T2S list of Milestones on the critical path



# Currency Participation Agreement

## Schedule 2 – T2S Programme Planning and Monitoring

---

### 59    **2    Scope and Objectives**

#### 60    **2.1    Scope**

61    This document on Programme Planning and Monitoring (Schedule 2 of the CPA) presents the  
62    commitment of the Eurosystem to establish and maintain a common programme plan (the T2S  
63    Programme Plan) and defines roles, responsibilities, processes and interactions of the parties to  
64    this Agreement.

#### 65    **2.2    Objectives**

66    The objectives of Schedule 2 are:

- 67    ▪    to document the baseline T2S Programme Plan and its underlying assumptions;
- 68    ▪    to define the framework for coordinating, managing and attempting to resolve potential  
69    disagreement on the T2S Programme Plan;
- 70    ▪    to provide all parties to this Agreement with the necessary information to develop, coordinate  
71    and manage their respective project plans in coordination with the T2S Programme Plan;
- 72    ▪    to define a monitoring and reporting framework on the progress against the T2S Programme  
73    Plan, including risks and issues; and
- 74    ▪    to define a monitoring framework for client readiness.

# Currency Participation Agreement

## Schedule 2 – T2S Programme Planning and Monitoring

---

### 75 **3 General Responsibilities of the parties to this Agreement**

#### 76 **3.1 General Responsibilities of the Eurosystem**

77 The Eurosystem commits to deliver and maintain the documentation, frameworks and processes,  
78 as defined in this Schedule and its Annexes. This means that at any point in time there will be a  
79 valid programme plan and an agreed framework to provide all parties to this Agreement with  
80 relevant information on the programme status detailing the main principles, frameworks,  
81 processes and tools to support the programme monitoring. The Eurosystem commits to follow the  
82 framework and processes defined in this Schedule.

83 Furthermore, the responsibilities of the Eurosystem include:

- 84 ▪ preparing and maintaining the T2S Programme Plan;
- 85 ▪ organizing a close coordination with Contracting CBs for reviewing and proposing changes  
86 to the plan to the Steering Level;
- 87 ▪ providing on a regular basis to Contracting CBs an accurate T2S Programme status  
88 assessment based on the T2S Programme Plan;
- 89 ▪ preparing reports on, and response plans for, risks and issues pertaining to the T2S  
90 Programme Plan with emphasis on activities and deliverables that impact Contracting CBs;
- 91 ▪ establishing and chairing the Project Managers Group (PMG) to review, discuss and agree on  
92 the T2S Operational Plan and the T2S Programme status for Contracting CBs relevant  
93 planning items with Contracting CSDs and Contracting CBs; and
- 94 ▪ establishing and attending a bilateral forum between the Eurosystem and each Contracting  
95 CB to review and discuss the Contracting CB's individual status assessment for their  
96 activities within the T2S Programme Plan.

#### 97 **3.2 General Responsibilities of the Contracting National Central Banks (CBs)**

98 Contracting CBs are responsible for ensuring their own readiness and for undertaking reasonable  
99 efforts to coordinate the readiness of their clients (including those who are directly connected to  
100 T2S) to start with T2S. Contracting CBs commit to follow the framework and processes defined  
101 in this Schedule and its Annexes.

102 Furthermore, the responsibilities of the Contracting CBs include:

# Currency Participation Agreement

## Schedule 2 – T2S Programme Planning and Monitoring

---

- 103   ▪ establishing their own adaptation plans to start operations with T2S in synchronisation with  
104   the T2S Programme Plan;
- 105   ▪ providing relevant and accurate information on progress and achievement of milestones,  
106   deliverables and synchronisation points, as well as on risks and issues, including response  
107   plans, potentially affecting the T2S Programme Plan. This is to enable the Eurosystem to  
108   maintain the T2S Programme Plan and consolidate the information received in the context of  
109   the monitoring of client readiness;
- 110   ▪ participating in the PMG to review, discuss and agree on the T2S Operational Plan and the  
111   T2S Programme status for activities, deliverables and milestones affecting the plans of  
112   Contracting CBs; and
- 113   ▪ participating in a bilateral forum between the Eurosystem and each Contracting CB to review  
114   and discuss the Contracting CB's individual status assessment of its activities within the T2S  
115   Programme Plan to become operational on T2S.

116

# Currency Participation Agreement

## Schedule 2 – T2S Programme Planning and Monitoring

---

### 117 **3.3 General responsibilities of the Project Manager Group (PMG)**

118 The PMG shall be composed of representatives of the Eurosystem, Contracting CSDs and  
119 Contracting CBs. Schedule 1 and Schedule 8 define the general role of the PMG. The following  
120 specifies the responsibilities of the PMG when supporting activities as defined in Schedule 2. The  
121 PMG shall:

- 122     ▪ Meet (physically or via conference call) on a regular basis and on an ad hoc basis when  
123         requested by one of the members. The PMG determines the frequency of its meetings based  
124         on its needs.
- 125     ▪ Assess the T2S Operational Plan and propose updates as detailed in Section 7.
- 126     ▪ Assess the T2S Programme status report and propose changes.
- 127     ▪ Identify risks and issues related to the execution of the T2S Plan
- 128     ▪ Propose mitigation or resolution measures for all risks and issues identified.
- 129     ▪ Discuss and propose solutions for multilateral issues related to the readiness of one of its  
130         members.
- 131     ▪ Act proactively and in good faith to achieve agreement between PMG members.
- 132     ▪ Prepare escalations on and escalate disagreements to the Steering Level.
- 133     ▪ Be informed on a regular (e.g. quarterly) basis and identify the needs of the changes to the  
134         T2S Scope Defining Set of Documents.

### 135 4 Supporting Documentation

136 The Eurosystem provides the documents described in this section as background information  
137 supporting programme planning and monitoring. The Annexes to Schedule 2 contain the baseline  
138 versions of these documents. These documents may evolve in the course of the programme as  
139 defined by the processes in Section 7.

140 The supporting documentation provides the reference that allows the reader to understand the  
141 content and construction of the plans and reports.

#### 142 4.1 T2S Programme Work Breakdown Structure

143 The Eurosystem defines and maintains a *Work Breakdown Structure (WBS)* for the purpose of  
144 programme planning and monitoring. The WBS is a Deliverable-oriented hierarchical  
145 decomposition of the work that the T2S Programme needs to execute to deliver T2S successfully.  
146 The WBS is the basis for grouping, aggregating and classifying the activities and deliverables for  
147 the T2S Programme Plan as well as for T2S programme status monitoring.

#### 148 4.2 T2S Programme Deliverables

149 A Deliverable is a unique and verifiable product, result, or capabilities to perform a service,  
150 required to complete a process or phase<sup>1</sup>.

151 The specification of the Deliverable consists of the information documented in the introduction to  
152 Annex 8 (e.g. name of the Deliverable, its classification according to the WBS)

153 The Eurosystem defines and maintains the List of Deliverables.

---

<sup>1</sup> In line with the PMBOK®

# Currency Participation Agreement

## Schedule 2 – T2S Programme Planning and Monitoring

---

### 154 **4.3 Milestones**

155 Milestones are significant points or events in the programme<sup>2</sup>. In addition to this standard  
156 milestone definition, the T2S Programme Plan includes specific milestones as defined in the  
157 subsequent paragraphs.

#### 158 **4.3.1 Synchronisation Points**

159 A synchronisation point is a point of time in the programme at which the T2S Programme is to  
160 reach a specific objective. The purpose of a synchronisation point is to monitor at foreseen time  
161 intervals that the progress of all parties to this Agreement is in line with the programme plan.

162 The Eurosystem provides the list of synchronisation points, which includes the list of the  
163 deliverables and milestones that require delivery or completion by the Eurosystem, Contracting  
164 CSDs and Contracting CBs in order to have successfully achieved the synchronisation point.

#### 165 **4.3.2 Critical Milestones**

166 Critical milestones are milestones on the critical path of the T2S Programme Plan.

---

<sup>2</sup> In line with the PMBOK®

### 167 **5 T2S Programme Plan**

168 The T2S Programme Plan is the common Eurosystem-CSD-CB plan. This chapter describes the  
169 three views of the T2S Programme Plan that the Eurosystem provides in order to allow  
170 Contracting CSDs and Contracting CBs to monitor the progress of the T2S Programme and  
171 update their own plans.

172 The T2S Programme WBS, based on work streams, provides the organisational structure for  
173 activities, tasks, and milestones of the plans.

#### 174 **5.1 CB-relevance of planning items**

175 The T2S Programme Plan differentiates between CB-relevant, non-CB-relevant and CB-internal  
176 planning items, specifically identified in the T2S Programme Plan.

##### 177 **5.1.1 CB-relevant planning items**

178 These are planning items (e.g. deliverables, milestones and processes) affecting, or being affected  
179 by the Contracting CBs.

- 180 ▪ Deliverables are CB-relevant if the Contracting CB is:
  - 181 ▪ the assignee;
  - 182 ▪ the addressee;
  - 183 ▪ the reviewer; or
  - 184 ▪ being consulted.
- 185 ▪ Meetings, workshops are CB-relevant when:
  - 186 ▪ the Contracting CB is participating (e.g. NECSG, PMG, AG, Sub Groups); or
  - 187 ▪ feedback is expected on specific topics (e.g. planning workshops)
- 188 ▪ Programme phases, activities and tasks are CB-relevant when the Contracting CB is involved  
189 as an actor, e.g. as a reviewer or an observer.
- 190 ▪ Programme phases, activities and tasks affecting the successful and timely completion of the  
191 Synchronisation Points.

# Currency Participation Agreement

## Schedule 2 – T2S Programme Planning and Monitoring

---

192 The Eurosystem will provide status reporting on these items in the PMG. Contracting CBs can  
193 review/analyse, discuss, and envisage alternative solutions for these items.

### 194 **5.1.2 Non CB–relevant planning items**

195 These are planning items (e.g. deliverables, milestones and processes) that do not require any  
196 Contracting CB involvement. The T2S Programme Plan does not present the details of activities  
197 or steps leading to a deliverable, but it provides milestones and summary tasks to ease plan  
198 readability.

199 Some examples for these items:

- 200 ▪ Internal Eurosystem activities or deliverables not impacting the critical path or the delivery of  
201 a Contracting CB deliverable (e.g. Internal Detailed Functional Specifications, Internal  
202 development process);
- 203 ▪ predecessor of processes highlighted above (all the tasks preparatory to the deliverables, e.g.  
204 information security preparatory work related to the deliverable ‘risk assessment’); and
- 205 ▪ independent processes (e.g. Internal Eurosystem governance).

206 The Eurosystem shall provide a status reporting and information on planning items that are not  
207 CB-relevant that are in the Operational Plan. However, Contracting CBs do not analyse and  
208 propose alternative solutions for these planning items.

### 209 **5.1.3 Internal CB planning items**

210 The T2S Programme Plan presents the main dependencies, relating to the completion process for  
211 specific milestones, called *Synchronisation Points*. Since Contracting CBs may be ready at  
212 various points in time, the T2S Programme Plan only presents the ultimate deadline before a  
213 delay could affect the critical path.

214 In the context of the monitoring of client readiness, Contracting CBs report progress on these  
215 items to their relationship manager, who in turn reports to the PMG. These items are under  
216 management responsibility of the Contracting CB. Therefore, the Eurosystem does not analyse or  
217 propose alternative solutions for these items.

## 218 **5.2 T2S Programme Plan Views**

219 The Eurosystem ensures the synchronisation of three different views of the T2S Programme Plan:



# Currency Participation Agreement

## Schedule 2 – T2S Programme Planning and Monitoring

---

- 220 - the T2S Detailed Plan, which presents the most detailed level and is to be used as  
221 reference to support detailed discussions when issues arise at the level of the T2S  
222 Operational Plan;
- 223 - the T2S Operational Plan, which forms the baseline subject to monitoring at PMG level;
- 224 - the T2S Executive Summary Plan, which is the plan communicated externally and which  
225 contains the most important dates of the T2S Programme Plan.

226 The Eurosystem produces an initial version of the plans in June of each year. The Eurosystem  
227 reviews the draft plans with Contracting CBs, wherever CB-relevant, in order to deliver an agreed  
228 T2S Operational Plan in September following the process described in Section 7 of the present  
229 Schedule.

### 230 5.2.1 T2S Detailed Plan

231 The T2S Detailed Plan provides for the T2S Programme the accurate and detailed planning for all  
232 deliverables and activities, relevant for Contracting CBs as well as selected deliverables,  
233 milestones and activities not CB-relevant or CB-internal to ease readability. It also provides the  
234 necessary details until the end of the project, bearing in mind that the accuracy of the information  
235 decrease with time. The purpose of the T2S Detailed Plan is to provide the single point of  
236 reference and to support discussion within the PMG when the T2S Operational Plan does not  
237 provide sufficient detail.

238 The Eurosystem produces an updated version of this plan in June. The Eurosystem reviews a draft  
239 T2S Detailed Plan with Contracting CBs, wherever CB-relevant, to support the delivery of the  
240 T2S Operational Plan in September.

241 The T2S Detailed Plan specifies:

- 242 ▪ all CB-relevant deliverables, milestones and activities (flagged as “CB-relevant”);
- 243 ▪ selected deliverables, milestones and tasks that are not-CB-relevant or CB-internal, but  
244 required for the understanding of the plan and for a global overview of the programme;
- 245 ▪ the synchronisation points for the monitoring of client readiness for Contracting CSDs and  
246 Contracting CBs; and
- 247 ▪ a Schedule of meetings and workshops, requiring the participation of Contracting CSDs  
248 and/or Contracting CBs.

# Currency Participation Agreement

## Schedule 2 – T2S Programme Planning and Monitoring

---

249 The T2S Programme Office provides updates of this plan as references to support the bilateral  
250 meetings for monitoring of client readiness (MCR) and the meetings of the PMG.

251 Should a regular update relate to an internal Eurosystem activity (4CB or ECB) and have no  
252 impact on the T2S Operational Plan (e.g. critical path, readiness; review period, etc.), the  
253 Eurosystem amends the T2S Detailed Plan, without prior discussion at PMG level.

### 254 **5.2.2 T2S Operational Plan (One-Year Rolling)**

255 The T2S Operational Plan aggregates the detail of the T2S Detailed Plan for one calendar year,  
256 including all tasks starting and/or finishing in that year. It also provides summary tasks and  
257 activities for the subsequent years until completion of the programme. This plan forms the  
258 baseline and is the basis for the reporting of the T2S Programme status. The purpose of the T2S  
259 Operational plan is:

- 260 ▪ to coordinate the activities and interactions on deliverables between the Eurosystem and  
261 Contracting CBs;
- 262 ▪ to enable Contracting CBs to develop and to monitor their own internal plans for T2S and to  
263 determine their resource requirements; and
- 264 ▪ to support Contracting CBs in performing their own assessment of the progress of the T2S  
265 Programme.

266 The T2S Operational Plan specifies for the one calendar year:

- 267 ▪ all major deliverables, dependencies, milestones and aggregated tasks ;
- 268 ▪ whether a planning item is CB-relevant;
- 269 ▪ the synchronisation point for the monitoring of client readiness for Contracting CSDs and  
270 Contracting CBs; and
- 271 ▪ a summary task of the period of time requiring the participation of Contracting CSDs and/or  
272 Contracting CBs.

# Currency Participation Agreement

## Schedule 2 – T2S Programme Planning and Monitoring

---

273 The Eurosystem provides updates of this plan to support the meetings for monitoring of client  
274 readiness and the meetings of the PMG. If a planning update affects another party (in the larger  
275 sense: readiness with external provider, review period, dependency Eurosystem, Contracting  
276 CSDs and Contracting CBs etc...) or influences the critical path, focussed information will be  
277 provided, including the explanation of the issue, the impact analysis and whenever relevant, the  
278 presentation of alternative solutions to be envisaged.

### 279 **5.2.3 T2S Executive Summary Plan**

280 The T2S Executive Summary Plan documents the milestones, synchronisation points and the  
281 duration of activities for the major deliverables and phases of the T2S Programme in order to  
282 provide a high-level summary view of the T2S Programme Plan.

### 283 **5.3 T2S Critical Path**

284 The critical path is the sequence of activities/tasks with the longest overall duration, determining  
285 the shortest time possible to complete the programme.

286 The T2S Detailed Plan documents the critical path for the Eurosystem activities and includes  
287 some external dependencies such as activities of Contracting CBs. Building the critical path for  
288 external dependencies requires a series of assumptions, as the plan cannot reflect detailed  
289 dependencies with each Contracting CB. The Eurosystem provides all such assumptions (Annex  
290 4 to this Schedule) when providing the T2S Detailed Plan. The T2S Detailed and T2S Operational  
291 Plan highlights (MS Project) the tasks belonging at the critical path in red. The critical path may  
292 change because of updates of the T2S Detailed Plan.

# Currency Participation Agreement

## Schedule 2 – T2S Programme Planning and Monitoring

---

### 293 **6 Monitoring frameworks**

294 The next sections define supporting materials and the methodology followed to assess progress  
295 and report the risks and issues.

296 Section 7 describes the underlying process.

### 297 **6.1 T2S Programme Status Assessment Framework**

#### 298 **6.1.1 Objectives and Scope**

299 The Eurosystem establishes a T2S Programme status assessment framework. The objectives of  
300 the framework are:

- 301 ▪ Organise regular reporting to all parties to this Agreement at the various levels of governance  
302 about the progress of the T2S Programme against the T2S Operational Plan;
- 303 ▪ to enable proper monitoring by providing a status report;
- 304 ▪ to facilitate the coordination of activities and interactions on deliverables between the  
305 Eurosystem and the Contracting CBs; and
- 306 ▪ to ensure that possible plan deviations against the Operational Plan are identified, discussed  
307 and addressed in a timely and appropriate manner.

308 In regularly scheduled (multilateral) assessment meetings with Contracting CBs, the Eurosystem  
309 reports on the progress against the T2S Operational Plan. Contracting CBs report their progress  
310 on deliverables pertaining to synchronisation points on a bilateral basis as part of the monitoring  
311 of client readiness.

#### 312 **6.1.2 Key Element of Programme Status Assessment and Monitoring**

313 The process description for programme assessment and monitoring is Annex 5 to this Schedule.

# Currency Participation Agreement

## Schedule 2 – T2S Programme Planning and Monitoring

---

### 314 6.1.2.1 T2S Progress Dashboard

315 The T2S Programme WBS specifies the structure of the dashboard template, presented in Annex  
316 5 and 6 to this Schedule. Using the WBS, the T2S dashboard presents a high-level overview of  
317 the progress achieved and the overall risk situation for the main streams of the programme  
318 (aggregation of activities and deliverables at work stream level).

319 The T2S Progress Dashboard presents the following elements:

- 320 ▪ status, with colour coding;
- 321 ▪ change (for status), compared to previous report;
- 322 ▪ trend, expected in the next report;
- 323 ▪ risk, with colour coding; and
- 324 ▪ change, (for risk) compared to previous report.

### 325 6.1.2.2 T2S Programme Status Report

326 The Eurosystem provides a T2S Programme Status. The T2S Programme Status Report includes:

- 327 ▪ the high-level T2S Progress Dashboard, as described in the previous Section;
- 328 ▪ per work stream a status assessment for each CB-relevant deliverable with a status “green”,  
329 “yellow” or “red”;
- 330 ▪ per work stream a detailed status assessment for each CB-relevant deliverable with a status  
331 “yellow” or “red”;
- 332 ▪ per work stream a risk assessment for each CB-relevant deliverable. A detailed risk  
333 assessment is provided in case the risk criticality is “yellow” or “red”; and
- 334 ▪ per work stream an issue description (incl. a response plan) for each issue pertaining to a CB-  
335 relevant Deliverable, in case a risk has materialised.

### 336 6.1.2.3 Conventions

337 The Eurosystem prepares a programme status assessment for each Deliverable, using colour  
338 coding (Green/Yellow/Red). This assessment evaluates the status of a Deliverable based on time,  
339 quality and scope.

# Currency Participation Agreement

## Schedule 2 – T2S Programme Planning and Monitoring

---

340 A specific colour, based on a three colours scheme, specifies the progress:

Colour	Description
Green	Deliverable is within the required scope and quality and is on time
Yellow	Deliverable will not have the required scope, will be delayed and/or not of the required quality if no corrective measures are taken
Red	Corrective measures have not delivered the expected effect or no corrective measures are possible. Deliverable will be delayed to achieve the required quality or scope if no extraordinary action is taken and requires escalation as described in section 7.2.

341

342 In addition to the colour reported for the progress assessment, the reporting of the Deliverable  
343 shows:

- 344 ▪ the change from the previous progress assessment; and
- 345 ▪ the expected trend for the next monitoring period.

346 The T2S Programme Status Report provides detailed information for each activity or Deliverable  
347 with a “yellow” or “red” status, including:

- 348 ▪ the list of achievements;
- 349 ▪ when relevant, the list of milestones missed or delayed; and
- 350 ▪ the list of mitigating actions already started or envisaged to manage the situation.

## 351 **6.2 T2S Risk and Issue Management and Monitoring Framework**

### 352 **6.2.1 Definitions, Scope and Objectives**

353 The Eurosystem establishes a T2S Risk and Issue Management and Reporting Framework as  
354 comprehensive tool for the handling of risks and issues. The term ‘risk’ refers to a ‘threat’ to the  
355 successful delivery of the T2S Programme. The framework does not track and manage  
356 ‘opportunities’. ‘Issues’ define materialised risks.

357 The objectives of the framework that all parties to this Agreement are to follow are:

- 358 ▪ to identify, manage and monitor risks and issues, potentially affecting the successful delivery  
359 of the T2S Programme;
- 360 ▪ to inform and discuss between all parties to this Agreement in case of risks/issues, which may

# Currency Participation Agreement

## Schedule 2 – T2S Programme Planning and Monitoring

---

361 potentially impact T2S Operational Plan;

362 ▪ to ensure that potential risks are addressed in a timely and appropriate manner; and

363 ▪ to ensure that planning issues are identified, discussed and addressed in a timely and  
364 appropriate manner.

### 365 **6.2.2 Principles**

366 The T2S Risk and Issue Management and Reporting Framework covers all risks, which may  
367 materialise during the programme’s lifetime (i.e. from today until ‘start operation’) and all  
368 identified issues. The framework also foresees for each risk a root cause analysis, which identifies  
369 the underlying cause leading to the risk. The assumption is that one root cause will exist for each  
370 risk.

371 The assessment of programme risks applies a common grading scale for probability and impact.  
372 A probability/impact matrix is then applied to determine the criticality zone each risk is allocated  
373 to. The actual risk situation (reflecting the status of implementation of mitigation measures) is  
374 decisive for assessing the criticality.

375 The parties to this Agreement shall report:

376 ▪ risks and the related risk response strategy as soon as possible following the formal risk  
377 assessment; and

378 ▪ issues as soon as possible after their identification.

### 379 **6.2.3 Risk and Issue Identification and Registration**

380 All parties to this Agreement ensure that the appropriate risk and issue management functions as  
381 well as operational processes are in place for the registration of identified risks and issues,  
382 potentially affecting the various programme deliverables and milestones. All parties to this  
383 Agreement commit to share risks and issues in the appropriate forums, as defined hereafter in the  
384 Sections “T2S Monitoring of Client Readiness Framework” and “Processes”.

### 385 **6.2.4 Risk Assessment**

386 The party to this Agreement identifying a risk (risk owner) shall evaluate the risk, based on:

387 ▪ the impact on the T2S Programme; and

# Currency Participation Agreement

## Schedule 2 – T2S Programme Planning and Monitoring

388   ▪ the probability of the risk materialising.

### 389   6.2.4.1   Risk Impact Grading Scale

390   The T2S Risk and Issue Management Framework applies a five-level impact grading scale:

391

		Impact				
		5 Very Severe	4 Major	3 Significant	2 Low	1 Negligible
Project Objective	Scope	Project end item is effectively useless	Scope change unacceptable	Major areas of scope affected	Minor areas of scope affected	Scope impact barely noticeable
	Quality	Project end item is effectively useless	Quality reduction unacceptable	Quality reduction requires an approval	Only very demanding applications are affected	Quality degradation barely noticeable
	Cost	> 10 M euros	1M – 10M euros	100,000 – 1M euros	10,000 – 100,000 euros	<10,000 euros
	Time <sup>3</sup>	> 20% time increase	10 - 20% time increase	5 - 10% time increase	1 - 5% time increase	< 1% time increase

392   **Figure 1:   Risk Impact Grading Scale**

393

394   The programme objectives scope, quality, cost and time are the basis for evaluating the risk  
 395   impact, following the international standard Project Management Book of Knowledge (PMBOK)  
 396   with the exception of the cost dimension. The use of this standard facilitates the assessment of the  
 397   risk by determining the effect of the materialisation of an identified risk on each project objective.  
 398   The highest category of the risk’s impact on a project objective defines the overall impact of the  
 399   risk.

400

---

<sup>3</sup> The percentages are calculated against the overall project duration.



# Currency Participation Agreement

## Schedule 2 – T2S Programme Planning and Monitoring

### 401 6.2.4.2 Risk Probability Grading Scale

402 The T2S Risk and Issue Management Framework applies a five-level probability grading scale.

403

Risk Probability				
1 Very Unlikely	2 Unlikely	3 Possible	4 Likely	5 Almost Certain

404 **Figure 2: Risk Probability Grading Scale**

405

406 The description of the risk probability level uses a percentage to classify the risk according to a  
 407 probability that it materialises. When possible, the assessment of the probability of a risk  
 408 eventuating is based on comparable large-scale programmes. However, the experience of  
 409 management in similar programmes and projects and the experience in operating in similar  
 410 complex environments and organisations are also factors in determining the probability for  
 411 common risk programme risks.

### 412 6.2.4.3 Probability-Impact Matrix

413 The impact of a T2S-related risk and the probability of occurring determine its level of criticality.

414 The T2S Programme uses the following probability/impact matrix for determining the criticality  
 415 of a risk according to a three colour scheme.

416

Impact	5	Red	Red	Red	Red	Red
	4	Yellow	Yellow	Red	Red	Red
	3	Green	Yellow	Yellow	Yellow	Yellow
	2	Green	Green	Green	Green	Yellow
	1	Green	Green	Green	Green	Green
		1	2	3	4	5
		Probability				

417 **Figure 3: Probability-Impact Matrix**

418

- 419 ▪ The intersection between the impact of the risk and its probability in the matrix specifies the  
 420 level of criticality of a risk to the T2S Programme (labelled with the colours green, yellow

# Currency Participation Agreement

## Schedule 2 – T2S Programme Planning and Monitoring

---

421 and red). The level of criticality determines on how the risk is managed.

422 In case the criticality level of a work stream for which several risks have been identified needs to  
423 be determined, the most severe risk determines the criticality level of the entire work stream.

### 424 **6.2.5 Risk Tolerance Policy**

425 The T2S Programme risk tolerance policy defines the level of programme risk that the ECB  
426 (ESCB/Eurosystem) is prepared to accept. The T2S Programme risk tolerance policy stipulates  
427 that the criticality of a risk and determines the body responsible for accepting a non-mitigated  
428 risk. The framework considers risks allocated to the green criticality level as accepted ex ante. All  
429 risks allocated beyond the tolerated level, i.e. those in the yellow and red zone, are subject to  
430 further risk management measures. Risks allocated to the red zone have the highest priority for  
431 mitigation.

### 432 **6.2.6 Risk Response Plan**

433 Risk response plans address identified T2S risks. Unless exempted by the confidentiality rules,  
434 the PMG monitors the implementation of the risk response plan, as indicated in the risk  
435 identification form, based on status reports received from the risk owners. The T2S Programme  
436 Office informs the Steering Level of the status of mitigation via the regular status reports. In case  
437 the risk has been reported to the other parties to this Agreement, the respective status information  
438 is provided in the (multilateral) monitoring meetings as defined hereafter in the Sections “T2S  
439 Monitoring of Client Readiness Framework” and “Processes”.

### 440 **6.2.7 Issue Response Plan**

441 Issue Response Plans address identified issues affecting the successfully delivery of T2S. The  
442 implementation of the issue response plan and sharing of information on issues is analogous to  
443 the process for risk response plans.

### 444 **6.2.8 Risk/Issue Reporting**

445 Based on the information received via the risk/issue notification forms, the Eurosystem registers  
446 each identified risk/issue. A risk/issue sheet provides high-level information on the risk/issue and  
447 its background and forms part of the T2S Programme Status Report.

# Currency Participation Agreement

## Schedule 2 – T2S Programme Planning and Monitoring

---

### 448 6.3 T2S Monitoring of Client Readiness Framework

#### 449 6.3.1 Definitions, Objectives and Scope

450 In the context of this Schedule, Client Readiness is defined as the capability of a Contracting CB  
451 (and their respective communities - including DCAH) to fulfil the legal, functional, technical and  
452 organisational requirements (i.e. all showstopper are resolved) to start operation in T2S relative to  
453 the synchronisation points (CB-relevant milestones), as specified in the T2S Programme Plan.

454 The term Monitoring of Client Readiness (MCR) defines the framework to ascertain the readiness  
455 of a Contracting CB (and their respective communities- including DCAH) to start operation in  
456 T2S based on the Contracting CBs' progress against the agreed milestones and deliverables of the  
457 T2S Operational Plan for the current phase of the T2S Programme. As a component of T2S  
458 Programme Planning and Monitoring, the parties to this Agreement agree to establish such a  
459 framework to allow the Eurosystem to monitor the readiness status of Contracting CBs to start  
460 operation with T2S.

461 The objectives of the MCR Framework are:

- 462 ▪ to ensure accurate reporting on the progress of a Contracting CB regarding its readiness level  
463 relative to the T2S Programme Plan;
- 464 ▪ to establish the necessary collaborative measures, rules, procedures and tools to support the  
465 monitoring process; and
- 466 ▪ to foster the communication between individual Contracting CBs and the Eurosystem on  
467 programme-plan-related issues, with a view to ensure timely and proactive identification and  
468 notification of any event that would have a material effect on the T2S Programme Plan and  
469 the start operation of T2S.

470 The scope of the MCR includes activities that the Contracting CBs and their communities  
471 (including DCAH) must undertake to ensure the required readiness level relative to the T2S  
472 Operational Plan and to the successful and timely completion of the Synchronisation Points.

473 MCR covers all phases of the T2S Programme until start of full operation of T2S with the  
474 successful implementation of the last of the planned migration waves. It also includes the  
475 monitoring of and reporting on the readiness of the Contracting CB clients, indirectly and directly  
476 connected to T2S. It should be noted that the Contracting CBs are responsible for tracking their  
477 own community (including DCAH) and accurately reporting to the Eurosystem.

# Currency Participation Agreement

## Schedule 2 – T2S Programme Planning and Monitoring

---

478 MCR encompasses the following activities:

- 479     ▪ the monitoring of the fulfilment of the mutual obligations, milestones and deliverables;
- 480     ▪ the monitoring and review of the mutual obligations in regular intervals and for individual  
481         periods, as bilaterally agreed, to ascertain their status as compared to the T2S Programme  
482         Plan; and
- 483     ▪ the identification and notification of delays or any event affecting the successful and timely  
484         completion of the Synchronisation Points.

### 485     **6.3.2 Monitoring of Client Readiness and Reporting**

#### 486     **6.3.2.1 Principles**

487 Gathering client readiness relevant information from the Contracting CB and comparing the  
488 Contracting CB's adaptation and migration plan to the overall T2S Programme Plan ensures that  
489 all Contracting CBs consistently and jointly progress towards a successful start operation in T2S.  
490 At the synchronisation points, the parties to this Agreement can assess whether they remain  
491 aligned with the T2S Programme Plan. MCR identifies risks (incl. potential mitigation measures)  
492 as well as issues (incl. response plans), which potentially affect the Eurosystem, Contracting  
493 CSDs or Contracting CBs or the successful start operation of T2S. Between synchronisation  
494 points, the Contracting CBs and the Eurosystem collaborate closely to support each other in the  
495 timely achievement of the relevant assessments, deliverables and milestones.

496 The parties to this Agreement agree to meet bilaterally to review, assess and discuss the  
497 Contracting CB's progress at least once per synchronisation point, based on agreed assessment  
498 criteria and status reporting methodology of this Schedule. Contracting CBs agree to report for  
499 readiness monitoring:

- 500     ▪ the progress against their adaptation plan and status of their deliverables; and
- 501     ▪ their risks and issues pertaining to their adaptation and affecting the successful completion of  
502         synchronisation points.

#### 503     **6.3.2.2 Periodicity**

504 The periodicity of meetings is dependent on the phase of the T2S Programme. Meetings will  
505 occur:

# Currency Participation Agreement

## Schedule 2 – T2S Programme Planning and Monitoring

---

- 506   ▪ on a quarterly basis from the signature of the CPA until the start of the User Testing;
- 507   ▪ on a monthly basis from the start of User Testing; and
- 508   ▪ on an ad hoc basis when requested by one of the parties to this Agreement.

### 509   **6.3.2.3    Organisation**

510   MCR includes all Contracting CBs participating in the T2S Programme. The Eurosystem  
511   monitors actively the degree of client readiness and asks the Contracting CBs for regular  
512   monitoring of the status of the different activities and of the preparedness level of their  
513   communities (including DCAH).

514   The Eurosystem monitors Client Readiness at three levels:

- 515   ▪ The first level of monitoring is at the operational level of the client relationship management,  
516   with support provided by the other functions of the T2S Programme. The formal  
517   communication and exchange of information between the Contracting CB and the T2S  
518   Programme Office takes place by means of (a) written submissions or (b) bilateral meetings  
519   between representatives of the Contracting CB and representatives of the T2S Programme.  
520   Aiming at ensuring an efficient and effective communication, a Contracting CB has a single  
521   person of contact within the client relationship area of the T2S Programme. The role of the  
522   single person of contact is to bundle the issues, comments and questions of the Contracting  
523   CB, to coordinate and align these issues, comments and questions with other Contracting  
524   CSDs and Contracting CBs and to ensure final response and implementation;
- 525   ▪ The second level of monitoring of client readiness is at the level of the PMG, which looks for  
526   common alternatives to resolve issues causing a delay or a risk of delay to a synchronisation  
527   point; and
- 528   ▪ The third level of client readiness monitoring is at the Steering Level.

# Currency Participation Agreement

## Schedule 2 – T2S Programme Planning and Monitoring

---

### 529 6.3.3 Client Readiness Reporting

530 The Eurosystem regularly reports on the overall Client Readiness (Contracting CSDs and  
531 Contracting CBs) as part of the programme status assessment and discusses the status with the  
532 Contracting CBs in multilateral meetings. The status of a specific Contracting CB in the context  
533 of MCR is subject to the confidentiality and transparency rules (see Section 6.3.4). The  
534 Eurosystem intends to publish aggregated client readiness-relevant information on a regular basis  
535 to provide a summary of the T2S readiness status covering the entire community (including  
536 DCAH). The Eurosystem reviews this assessment with the Contracting CBs prior to publication.

### 537 6.3.4 Confidentiality and Transparency Rules

538 The Eurosystem is committed to full transparency regarding T2S. T2S communication on client  
539 readiness addresses a wide spectrum of recipients, comprising individual Contracting CBs,  
540 various T2S governance bodies and the public.

541 Full transparency does not preclude confidentiality. As a matter of principle, and as reflected in  
542 the business rules below, Contracting CB readiness status and internal issues, discussed in the  
543 MCR bilateral meetings, remain confidential unless they affect the overall readiness, other  
544 Contracting CBs, the T2S Programme organisation and/or the T2S business case. Communication  
545 of any other topics to a third party shall require prior written mutual consent. The business rules,  
546 which govern the confidentiality versus transparency dimensions, are set out below:

# Currency Participation Agreement

## Schedule 2 – T2S Programme Planning and Monitoring

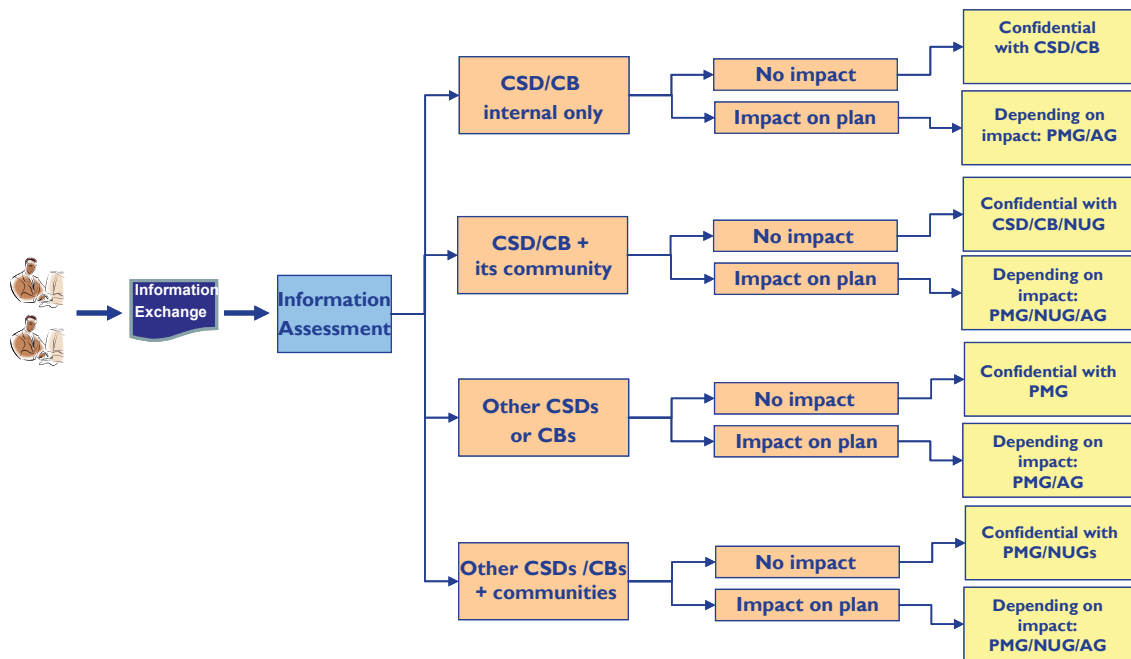

547

# Currency Participation Agreement

## Schedule 2 – T2S Programme Planning and Monitoring

---

### 548 **7 Processes**

549 The below processes only cover topics related to Schedule 2; therefore, the process actors' roles,  
550 as described below, are only applicable to the Schedule 2 topics and should not be read as a  
551 limitation to their roles in other topics of the CPA.

#### 552 **7.1 Methodology and Conventions**

553 The T2S monitoring process is represented in a diagram and supported by a high-level process  
554 description.

555 Individual sub-processes are described, but not supported by business diagrams.

556 There is no specific section to describe the individual activities, decision points or business rules.

557 Likewise, the adaptation process for Schedule 2 Annexes is represented in a diagram and  
558 supported by a high-level process description.

559









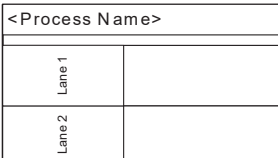

# Currency Participation Agreement

## Schedule 2 – T2S Programme Planning and Monitoring

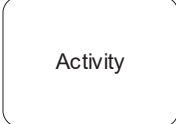
560 **7.1.1 Standards**

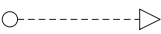
561 The document uses a simplified version of the Business Process Modelling Notation (BPMN) 2.0  
 562 notation, as documented below.

563

Convention	Description
	Pools (Participants) and lanes represent responsibilities of a business actor for activities in a process. A pool or a lane can be an organization, a role, or a system. Lanes may subdivide pools or other lanes hierarchically.
	This symbol represents the starting point for a process.
	This symbol represents the termination of a process.
	An Activity is a unit of work or action.
	This symbol defines the execution order of activities.
	This symbol defines an indirect execution of activity (e.g. sending/exchange of information).
	This symbol represents a decision, resulting in the triggering of different activities. It typically follows an activity.
	Gateway, used to ease the readability of the flow transfers
	A Data Object represents information flowing through the process, such as business documents, e-mails, or letters
	Indicates reference to an external process not described in the current business process map

# Currency Participation Agreement

## Schedule 2 – T2S Programme Planning and Monitoring

### 564 7.2 Programme Plan Preparation, Adaptation and Assessment Review Process

565

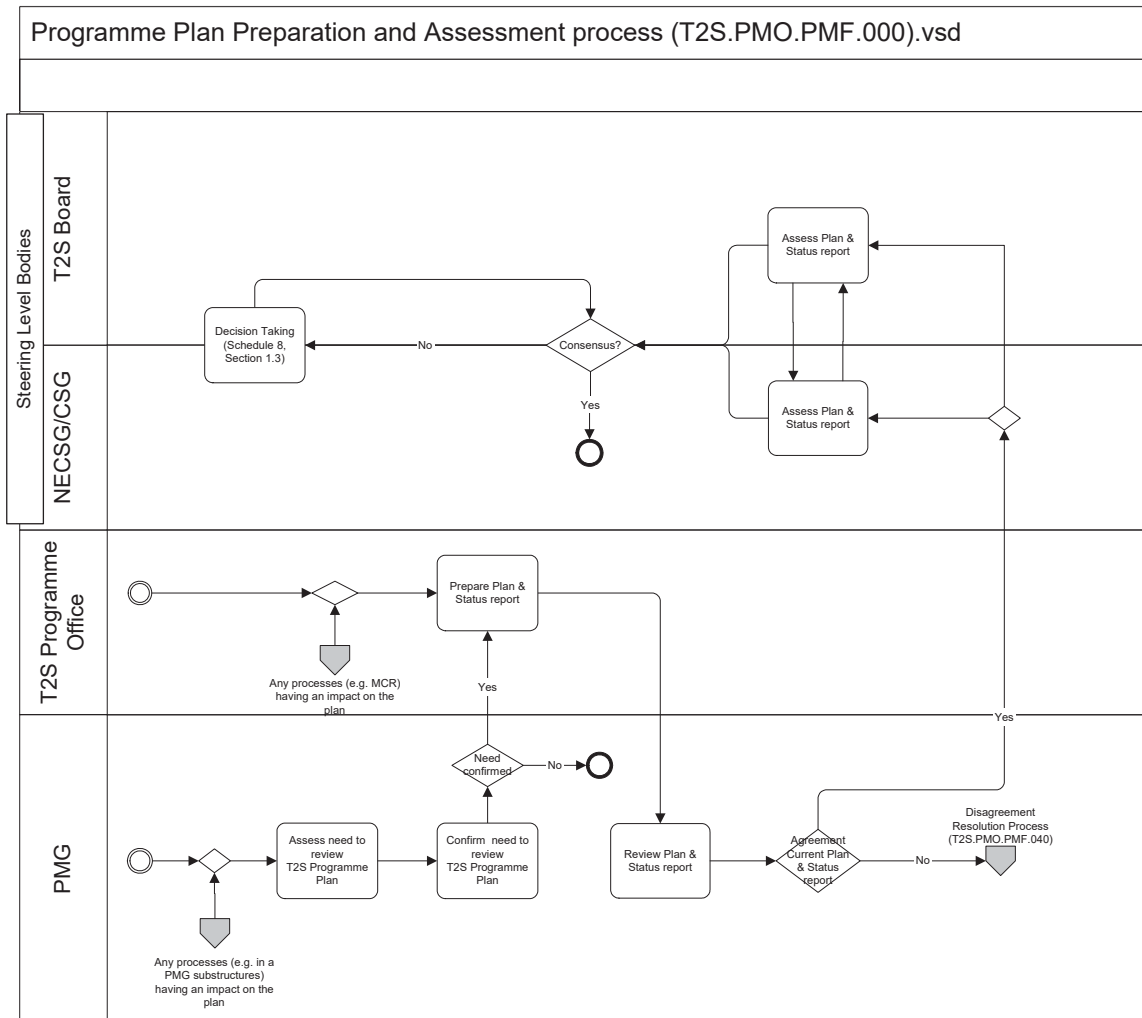

566

567

# Currency Participation Agreement

## Schedule 2 – T2S Programme Planning and Monitoring

---

### 568 7.2.1 Process Actors and their Roles

Process Actor	Process Role
T2S Programme Office	<p>The T2S Programme Office is responsible for collecting information from the Eurosystem, Contracting CSDs and Contracting CBs in order to prepare for PMG and Steering Level review:</p> <ul style="list-style-type: none"><li>▪ An updated T2S Programme Plan;</li><li>▪ A Programme Status Report (including progress, risks and issues).</li></ul> <p>The T2S Programme Office sends the relevant information (T2S Programme Plan and Programme Status Report) to the PMG, at least 1 week before PMG meetings. The T2S Programme Office is responsible for organising and chairing the PMG meetings.</p>
PMG	<p>In this process, the PMG is responsible for :</p> <ul style="list-style-type: none"><li>• Assessing and agreeing on the updates of the T2S Operational Plan</li><li>• Assessing and agreeing on the T2S Programme status report.</li></ul> <p>Its responsibility is to analyse the plan and the reporting packages, propose improvements or changes, and highlight risks and issues. When alternatives for solving an issue exist, the PMG will assess them and propose the best way forward.</p> <p>It is the responsibility of the PMG to act pro-actively and in good faith to try to achieve agreement between PMG members.</p>
NECSG	<p>The NECSG is responsible for assessing the programme plan and programme status, taking into account the recommendations supplied by the PMG and taking all necessary steps to reach a consensus at Steering Level.</p>
T2S Board	<p>The T2S Board is responsible for assessing the programme plan and programme status, taking into account the recommendations supplied by the PMG and taking all necessary steps to reach a consensus at Steering Level. The T2S Board also coordinates the work at Steering Level to reach a consensus following the process described in Schedule 8, Section 1.3.</p>

569

# Currency Participation Agreement

## Schedule 2 – T2S Programme Planning and Monitoring

---

### 570 7.2.2 High-Level Process Description

571 This section provides an overview of the process to monitor the T2S Programme Plan. This  
572 includes progress and risk reporting, and adaptation to the plan. This process encompasses the  
573 ongoing monitoring of the programme by the different actors. It applies to production of the  
574 programme status reports and to updates of the plan. It may also result in changes to the different  
575 supporting documents, e.g. to document changes in planning assumptions. This process does not  
576 apply to changing the layouts of plans and supporting documents, as described in the Annexes of  
577 this Schedule 2. Such changes follow the process for the adaptation of Schedules described in  
578 section 7.3.

579 The T2S Programme Office collects information from the Eurosystem, Contracting CSDs and  
580 Contracting CBs for plan updates and status reporting.

581 Based on the information received, the T2S Programme Office updates the T2S Operational Plan,  
582 prepares a Programme status reports.

583 When applicable, the T2S Programme Office prepares presentations on changes, impacts and  
584 alternative solutions.

585 The T2S Programme Office sends the various plans and the programme status report to the PMG  
586 at least one week before the meeting.

587 The T2S Programme office presents the overall programme plan and status during the PMG  
588 sessions for review and discussion.

589 Once the PMG has reviewed and agreed on the T2S Operational Plan and status reports, it  
590 forwards the plan and status reports to the Steering Level for endorsement. The T2S Board  
591 coordinates the work at Steering Level to reach a consensus following the process described in  
592 Schedule 8, Section 1.3.

593 In case of disagreement on the implementation, the PMG may initiate the PMG disagreement  
594 resolution process in order to seek for guidance from the Steering Level.

595

596 The PMG meets at least quarterly or as agreed with the PMG members.

597

# Currency Participation Agreement

## Schedule 2 – T2S Programme Planning and Monitoring

### 598 7.3 Adaptation Process for updated Annexes without affecting the plan:

599

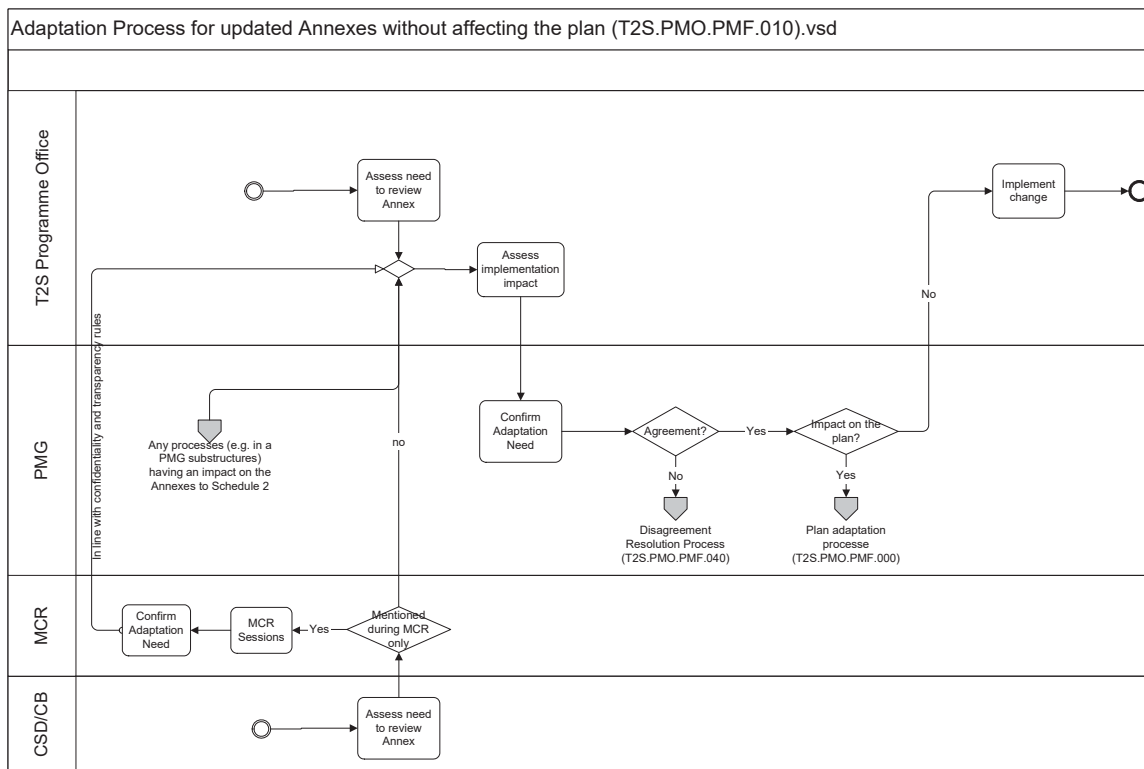

600

601

### 602 7.3.1 Process Actors and their Roles

Process Actor	Process Role
T2S Programme Office	The T2S Programme Office is responsible for: <ul style="list-style-type: none"> <li>identifying and raising adaptation requests;</li> <li>collecting adaptation requests;</li> <li>undertaking the impact assessment for the requested adaptation;</li> <li>communicating the results of the impact analysis to the PMG; and</li> <li>implementing the adaptation in the applicable processes and templates.</li> </ul>
CB	<ul style="list-style-type: none"> <li>The Contracting CBs are responsible identifying and raising adaptation requests, if relevant.</li> </ul>
Monitoring of Client Readiness	The MCR is responsible for providing information on the reasons for the adaptation request to the T2S Programme Office to allow for an impact assessment.

# Currency Participation Agreement

## Schedule 2 – T2S Programme Planning and Monitoring

---

PMG	In this process, the PMG is responsible for: <ul style="list-style-type: none"><li>▪ reviewing and discussing the adaptation requests;</li><li>▪ confirming the need of the adaptation or rejecting the request to the Steering Level; and</li><li>▪ escalating Disagreement on adaptation request to the Steering Level.</li></ul>
-----	---

603 **7.3.2 High Level Process Description**

604 This section provides a process to adapt the Annexes to the present Schedule that do not affect the  
605 plan over time in a controlled way. This process is valid to change the layout of the plan and of  
606 the supporting documentation, but it does not apply for changing the plan (e.g. the Eurosystem  
607 and/or CBs may wish to review the Annexes to Schedule 2 of this CPA in order to improve  
608 reporting). Adaptations approved at Steering Level, do not need to go through this procedure, and  
609 should be directly implemented.

610 The T2S Programme Office and/or CBs may wish to change an Annex.

611 The T2S Programme Office collects the change(s) request. Thereafter, the T2S Programme Office  
612 assesses the change(s) request. The PMG reviews the change(s) request together with the T2S  
613 Programme Office assessment.

614 After agreement on the change(s) at PMG level, the T2S Programme Office implements the  
615 change(s).

616 In case of disagreement, the PMG may initiate the disagreement resolution process to get  
617 agreement on the proposed change(s).

618

# Currency Participation Agreement

## Schedule 2 – T2S Programme Planning and Monitoring

### 619 7.4 Disagreement Resolution process

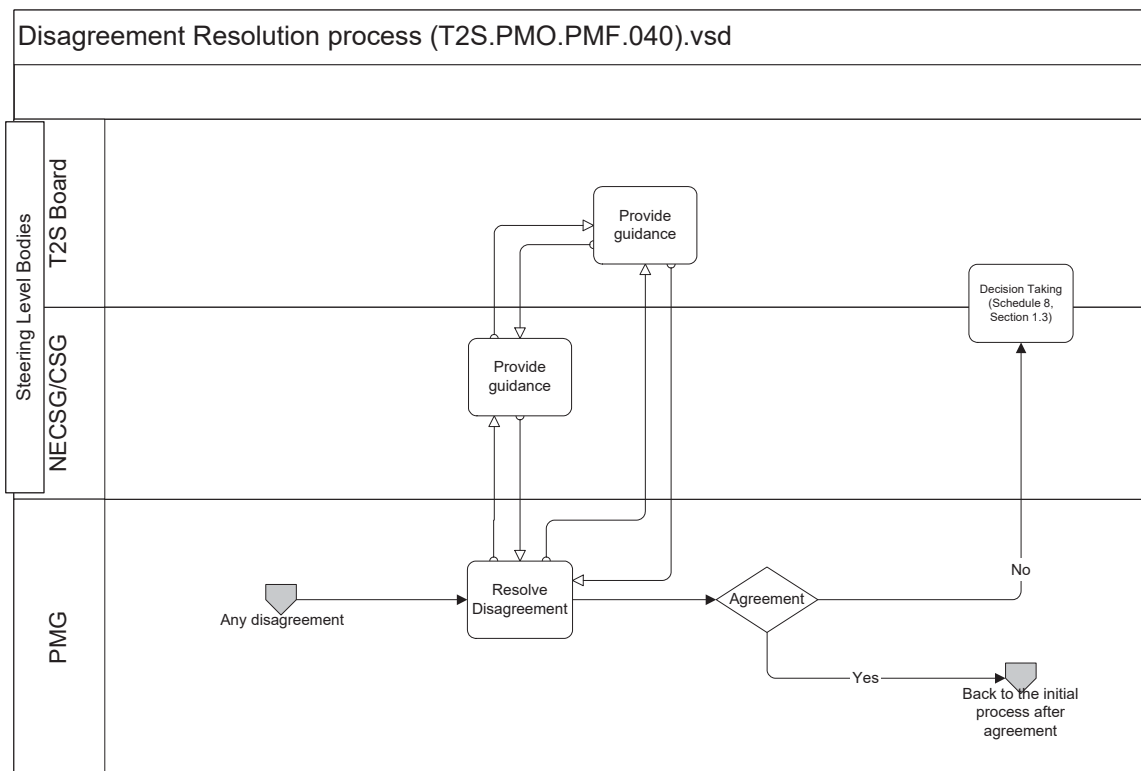

620

621

#### 622 7.4.1 Process Actors and their Roles

623

Process Actor	Process Role
PMG	The PMG is responsible for taking all necessary actions to solve the disagreement.
NECSG	The NECSG is responsible for discussing with T2S Board any disagreement escalated by the PMG and for providing guidance to the PMG. In case of outstanding disagreement after escalation at PMG level, the NECSG takes all necessary steps to reach a consensus at Steering Level.
T2S Board	The T2S Board is responsible for discussing with NECSG any disagreement escalated by the PMG and for providing guidance to the PMG. In case of outstanding disagreement after escalation at PMG level, the T2S Board coordinates the work at Steering Level to reach a consensus following the process described in Schedule 8, Section 1.3.

624

625

# Currency Participation Agreement

## Schedule 2 – T2S Programme Planning and Monitoring

---

626 **7.4.2 High Level Process Description**

627 This Section describes the process to be followed in case of disagreement within the PMG.

628 In case of disagreement within the PMG, the PMG escalates to the Steering Level for guidance on  
629 how to mitigate the disagreement.

630 The Steering Level discussed the escalated issue in view of providing guidance to the PMG.

631 The Parties should aim to conducting the process of resolving disagreements within 2 weeks.

632 In case of outstanding disagreement after escalation at PMG level, the T2S Board coordinates the  
633 work at Steering Level to reach a consensus following the process described in Schedule 8,  
634 Section 1.3, before a potential escalation.

635





# **CURRENCY PARTICIPATION AGREEMENT**

## **SCHEDULE 2 – ANNEX 1**

### **T2S EXECUTIVE SUMMARY PLAN**

# Executive Summary Plan

# T2S Executive Summary Plan

Work Streams	2011				2012				2013				2014			
	Q1	Q2	Q3	Q4	Q1	Q2	Q3	Q4	Q1	Q2	Q3	Q4	Q1	Q2	Q3	Q4
Product Readiness	User Requirements			◆ V 5.1 20/10/11												
	User Handbook						◆ V1.0 27/12/12									
	User Detailed Functional Specification			◆ V1.2 31/10/11			◆ V1.2.1 Sept. 2012									
	Eurosystem Software Development	◆ UDFS/IDFS Integrated in Development Process 01/04/11		◆ Interface Specification frozen 31/10/11			◆ Technical Stability 28/09/12	◆ Functional Stability 29/03/13	◆ Finish Last Iteration 30/12/13							
EAT	4CB Internal Acceptance Test (IAC)			◆ Start 02/04/12									◆ End 30/12/13			
	Eurosystem Acceptance Test	◆ Start Preparation Phase 02/01/11											◆ Start 15/01/14	◆ End 30/09/14		
Operational Readiness	Infrastructure & Network													◆ VAN Acceptance Completed 11/10/13	◆ Availability Dedicated Link 01/11/13	
	Migration			◆ Start Preparation 02/01/12												
Client Readiness	CSD/CB Feasibility Assessment		◆ Start 02/11/11													

\* Including buffer

# T2S Executive Summary Plan

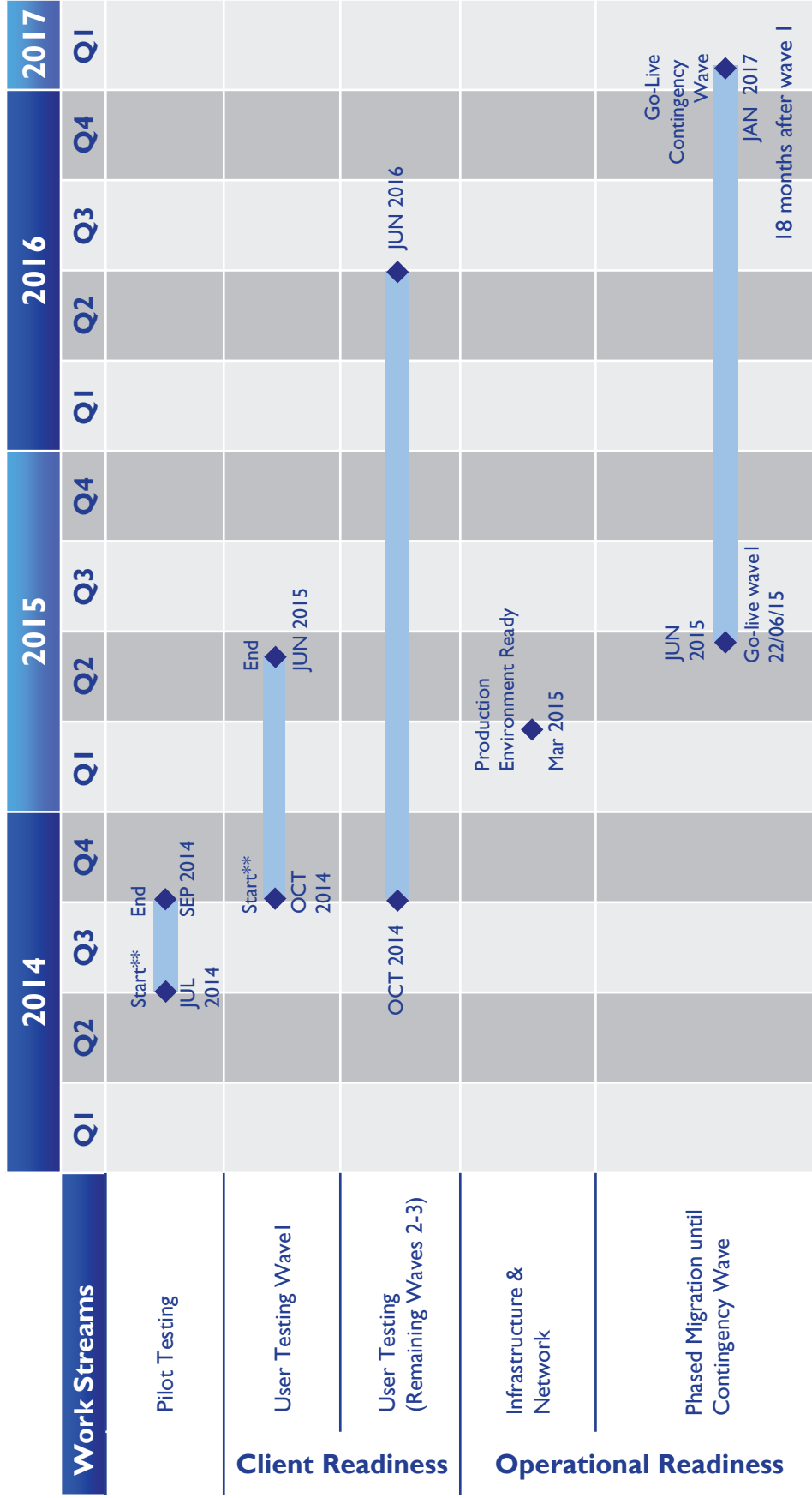

\*\* For simplicity reasons, connectivity's activities which could be performed prior to the start do not appear on this plan view

# Client Readiness Tracking Synchronisation Points 1

Synchronisation Points	2011				2012				2013				2014			
	Q1	Q2	Q3	Q4	Q1	Q2	Q3	Q4	Q1	Q2	Q3	Q4	Q1	Q2	Q3	Q4
SP1 - Start Feasibility Confirmed			20/12/11	◆												
SP2 - Feasibility Confirmation						10/08/12	◆									
SP3 – T2S Programme Plan Comprehensiveness							17/12/12	◆								
SP4 - Network Providers Confirmed												24/04/14	◆			
SP5 - Eurosystem ready for EAT											15/01/14	◆				
SP6 - Eurosystem Ready for User Testing														02/09/14	◆	
SP7 - Start Connectivity Test														07/07/14	◆	
SP8 - Start Bilateral Interoperability Testing															01/10/14	◆

# Client Readiness Tracking Synchronisation Points 2

Synchronisation Points	2014				2015				2016				2017	
	Q1	Q2	Q3	Q4	Q1	Q2	Q3	Q4	Q1	Q2	Q3	Q4	Q1	
SP9 - Start Multilateral Interoperability Test (by Wave)			DEC 2014			JUN 2015								
SPI0 - Start Community Test (by Wave)				MAR 2015				NOV 2015						
SPI1 - Start Business Day Test (by Wave)					MAY 2015				APR 2016					
SPI2 - End of User Testing (by Wave)					JUN 2015					JUN 2016				
SPI3 - Eurosystem Ready for Production (by Wave)			DEC 2014							MAR 2016				
SPI4 - Ready to Connect to Prod. Environment (by Wave)				FEB 2015						MAR 2016				
SPI5 - Ready to upload Static Data (by Wave)				APR 2015						APR 2016				
SPI6 - Ready for Migration Weekend and Start Operations (by Wave)					JUN 2015									
SPI7 - Closing of migration (after Contingency wave)														Contingency Wave JAN 2017 March 2017

# CURRENCY PARTICIPATION AGREEMENT

## SCHEDULE 2 – ANNEX 2 T2S OPERATIONAL PLAN

***Disclaimer:***

Planning is an ongoing process and Annexes with planning elements are subject to change during the lifetime of a project. Planning workshops with CSDs and CBs will continue to agree on the planning for Connectivity, User Testing and Migration. Subsequent plan updates follow the process, documented in the Schedule 2, Section 7.

Annexes 2, 3, 4, 7, 8, 9 and 10 document the planning status as at 7 Nov. 2011.

T2S Operational Plan with Critical Path

31/10/2011

ID	ID Number (Number 1)	Task Name	CSD/CB relevant activities	Duration	Start	Finish	Resource Group for PMG	2011		2012		2013		2014		2015		2016		2017	
								1st Half	2nd Half	1st Half	2nd Half	1st Half	2nd Half	1st Half	2nd Half	1st Half	2nd Half	1st Half	2nd Half	1st Half	2nd Half
1	100	<b>PRODUCT READINESS</b>		1945d	Tue 01/04/08	Fri 02/10/15															
2	500	SPECIFICATION AND DOCUMENTATION		1417d	Fri 28/11/08	Mon 19/05/14															
3	1100	REQUIREMENTS		692d	Thu 26/03/09	Thu 17/11/11															
35	16100	[Deliverable] - User Requirement Document (URD) 5.01	◆	0d	Thu 17/11/11	Thu 17/11/11	Eurosystem														
36	18100	SPECIFICATIONS		1401d	Fri 28/11/08	Thu 24/04/14															
37	18200	General Specification (GS)		1401d	Fri 28/11/08	Thu 24/04/14															
45	26100	GS v. 2.0		257d	Wed 24/04/13	Thu 24/04/14															
46	26200	Internal Eurosystem Preparation [General Specifications v. 2.0]		219d	Mon 10/06/13	Thu 17/04/14															
55	34150	[Deliverable] - General Specification (GS) V. 2.0	◆	0d	Wed 24/04/13	Wed 24/04/13	Eurosystem														
67	47100	General Functional Specifications (GFS)		1231d	Mon 19/01/09	Mon 14/10/13															
81	60100	GFS 4.0 - aligned with URD 5.0		347d	Tue 02/02/10	Wed 01/06/11															
99	74400	Feedback of the ECB T2S project team to the Market on GFS V4.0 13/04	◆	15d	Mon 04/04/11	Fri 22/04/11	Eurosystem														
101	74500	Delivery GFS Note	◆	0d	Wed 01/06/11	Wed 01/06/11	Eurosystem														
102	73400	GFS 5.0		139d	Tue 02/04/13	Mon 14/10/13															
103	73500	Internal Eurosystem Preparation [Production of the GFS V5.0]		134d	Tue 02/04/13	Mon 07/10/13															
113	88150	[Deliverable] - General Function Specification (GFS) V 5.0	◆	0d	Mon 14/10/13	Mon 14/10/13	Eurosystem														
132	155150	Internal Detailed Functional Specification (IDFS)		910d	Wed 16/12/09	Tue 18/06/13															
133	156100	Settlement Algorithm Objectives Document		327d	Fri 15/01/10	Fri 15/04/11															
148	165100	Production of IDFS		910d	Wed 16/12/09	Tue 18/06/13															
156	172200	WS - Delivery IDFS V0.85 to the Development Coordination		0d	Tue 15/02/11	Tue 15/02/11	Eurosystem														
170	97100	User Detailed Functional Specifications (UDFS)		1300d	Thu 01/01/09	Tue 07/01/14															
182	590200	Work on Messages Pillar I-III		1300d	Thu 01/01/09	Tue 07/01/14															
183	105100	Message standardisation		1300d	Thu 01/01/09	Tue 07/01/14															
194	116200	Production of UDFS V1.0, V1.1, V1.2 (in line with GFS V4.0)		560d	Mon 03/08/09	Fri 23/09/11															
195	116300	Production of UDFS V1.0 [dialogue between T2S and its users and detailed msg specification]		560d	Mon 03/08/09	Fri 23/09/11															
231	190500	UDFS v1.0 - Messages		207.75d	Thu 01/04/10	Fri 14/01/11															
232	190550	Pillar III (T2S specific messages)		207.75d	Thu 01/04/10	Fri 14/01/11															
233	190580	Detailed T2S message specification, development and T2S documentation for UDFS		207.75d	Thu 01/04/10	Fri 14/01/11															
239	192400	Production of first draft T2S customised schema files/documentation by 4CB		79.75d	Tue 28/09/10	Fri 14/01/11															
241	134940	Validation of draft T2S customised schema files/documentation by SGMS (incl. feedback of SGMS)	◆	47d	Thu 11/11/10	Fri 14/01/11	SGMS														
242	190450	Validations of the version v0.3 to produce the UDFS V1.0		517d	Thu 01/10/09	Fri 23/09/11															

Task Critical Milestone Critical Task Milestone Group By Summary



T2S Operational Plan with Critical Path  
31/10/2011

ID	ID Number (Number-1)	Task Name	CSD/CB relevant activities	Duration	Start	Finish	Resource Group for PMG	2011		2012		2013		2014		2015		2016		2017	
								1st Half	2nd Half	1st Half	2nd Half	1st Half	2nd Half	1st Half	2nd Half	1st Half	2nd Half	1st Half	2nd Half	1st Half	2nd Half
245	190470	ECB T2S programme Office Market review of UDFS v0.3 (one month)	◆	21d	Thu 30/12/10	Wed 26/01/11	Eurosystem	Q4	Q1	Q1	Q2	Q2	Q3	Q3	Q4	Q4					
246	190490	Reception of consolidated ECB/Market feedback on UDFS v0.3 to FC	◆	0d	Wed 26/01/11	Wed 26/01/11	Eurosystem	Q4	Q1	Q1	Q2	Q2	Q3	Q3	Q4	Q4					
247	190560	Integration of PMG & ECB T2S Programme Office comments in v0.3 to produce the V1.0 of UDFS (1,5 month)	◆	30d	Thu 27/01/11	Wed 09/03/11	Eurosystem	Q1	Q1	Q2	Q2	Q3	Q3	Q4	Q4						
250	190700	Delivery of UDFS V1.0 to the Market by the ECB	◆	1d	Fri 25/03/11	Fri 25/03/11	Eurosystem	Q1	Q1	Q2	Q2	Q3	Q3	Q4	Q4						
251	190800	Validation of complete UDFS V1.0 by the Market	◆	107d	Thu 10/03/11	Fri 05/08/11	Eurosystem	Q1	Q1	Q2	Q2	Q3	Q3	Q4	Q4						
254	195100	Feedback from the Market on the UDFS V1.0	◆	45d	Mon 28/03/11	Fri 27/05/11	CSDs	Q1	Q1	Q2	Q2	Q3	Q3	Q4	Q4						
256	196100	Consolidation of Market comments by the ECB	◆	10d	Mon 30/05/11	Fri 10/06/11	Eurosystem	Q1	Q1	Q2	Q2	Q3	Q3	Q4	Q4						
257	198100	Integration of Market comments in complete UDFS V1.0 (two months)	◆	40d	Mon 13/06/11	Fri 05/08/11	Eurosystem	Q1	Q1	Q2	Q2	Q3	Q3	Q4	Q4						
258	199100	Delivery to ECB T2S Programme Office of UDFS V1.1	◆	0d	Fri 05/08/11	Fri 05/08/11	Eurosystem	Q1	Q1	Q2	Q2	Q3	Q3	Q4	Q4						
259	199200	UDFS v1.2 - Messages	◆	486d	Thu 01/10/09	Wed 10/08/11	Eurosystem	Q3	Q3	Q4	Q4	Q1	Q1	Q2	Q2						
260	134500	Pillar II (new standard)	◆	288d	Thu 28/01/10	Fri 04/03/11	Eurosystem	Q3	Q3	Q4	Q4	Q1	Q1	Q2	Q2						
262	134570	Detailed T2S message specification and development of UDFS documentation for UDFS	◆	288d	Thu 28/01/10	Fri 04/03/11	Eurosystem	Q3	Q3	Q4	Q4	Q1	Q1	Q2	Q2						
263	134600	Customisation of draft ISO schema files (incl. definition of fields)/documentation, validation of draft T2S files/documentation by the SGMS	◆	288d	Thu 28/01/10	Fri 04/03/11	SGMS	Q3	Q3	Q4	Q4	Q1	Q1	Q2	Q2						
266	124150	Final Validation Pillar II by the SGMS	◆	0d	Fri 04/03/11	Fri 04/03/11	SGMS	Q3	Q3	Q4	Q4	Q1	Q1	Q2	Q2						
267	134700	Pillar III (T2S specific messages)	◆	486d	Thu 01/10/09	Wed 10/08/11	Eurosystem	Q3	Q3	Q4	Q4	Q1	Q1	Q2	Q2						
268	134730	Detailed T2S message specification, development and T2S documentation for UDFS	◆	486d	Thu 01/10/09	Wed 10/08/11	Eurosystem	Q3	Q3	Q4	Q4	Q1	Q1	Q2	Q2						
269	134770	Creation of UDFS by 4CB for validation by SGMS (as BNG)	◆	371d	Thu 01/10/09	Wed 02/03/11	Eurosystem	Q3	Q3	Q4	Q4	Q1	Q1	Q2	Q2						
271	134830	SGMS Validate the HLBR (incl. Incorporation of comments by 4CB)	◆	330d	Fri 27/11/09	Wed 02/03/11	SGMS	Q3	Q3	Q4	Q4	Q1	Q1	Q2	Q2						
273	134900	Production of first draft T2S customised schema files/documentation by 4CB	◆	100.75d	Wed 23/03/11	Wed 10/08/11	Eurosystem	Q4	Q4	Q1	Q1	Q2	Q2	Q3	Q3						
275	134950	Validation of T2S customised files by SGMS (incl. Incorporation of comments by 4CB)	◆	61d	Wed 18/05/11	Wed 10/08/11	SGMS	Q4	Q4	Q1	Q1	Q2	Q2	Q3	Q3						
276	134150	Final Validation Pillar III by the SGMS	◆	0d	Fri 01/07/11	Fri 01/07/11	SGMS	Q4	Q4	Q1	Q1	Q2	Q2	Q3	Q3						
277	200100	Final validation of complete UDFS V1.1 by ECB T2S Programme Office	◆	34d	Mon 08/08/11	Fri 23/09/11	Eurosystem	Q4	Q4	Q1	Q1	Q2	Q2	Q3	Q3						
288	211100	[Deliverable] - User Detailed Functional Specification (UDFS) V1.2	◆	0d	Mon 31/10/11	Mon 31/10/11	Eurosystem	Q4	Q4	Q1	Q1	Q2	Q2	Q3	Q3						
289	211200	Start feasibility study	◆	0d	Wed 02/11/11	Wed 02/11/11	CSDs/CBs	Q4	Q4	Q1	Q1	Q2	Q2	Q3	Q3						
290	211300	Production of UDFS V1.2.1 (CR and Architecture Issues)	◆	290d	Mon 01/08/11	Fri 07/09/12	Eurosystem	Q4	Q4	Q1	Q1	Q2	Q2	Q3	Q3						
322	214800	[Deliverable] - User Detailed Functional Specification (UDFS) V1.2.1	◆	0d	Fri 07/09/12	Fri 07/09/12	Eurosystem	Q4	Q4	Q1	Q1	Q2	Q2	Q3	Q3						
323	215100	UDFS v 2.0	◆	86d	Wed 21/08/13	Thu 19/12/13	Eurosystem	Q4	Q4	Q1	Q1	Q2	Q2	Q3	Q3						
326	217100	Validation and revision of UDFS v.2.0 after IAC	◆	64d	Fri 20/09/13	Thu 19/12/13	Eurosystem	Q4	Q4	Q1	Q1	Q2	Q2	Q3	Q3						
327	217200	Internal Eurosystem Preparation [Validation and revision of UDFS v.2.0 after IAC]	◆	62d	Fri 20/09/13	Tue 17/12/13	Eurosystem	Q4	Q4	Q1	Q1	Q2	Q2	Q3	Q3						
335	223150	[Deliverable] - UDFS v.2.0	◆	0d	Thu 19/12/13	Thu 19/12/13	Eurosystem	Q4	Q4	Q1	Q1	Q2	Q2	Q3	Q3						

Legend: Task (blue box), Milestone (black diamond), Critical Milestone (red diamond), Critical Task (red box), Project Summary (grey arrow), Group By Summary (grey arrow)

T2S Operational Plan with Critical Path  
31/10/2011

ID	ID Number (Number 1)	Task Name	CSD/CB relevant activities	Duration	Start	Finish	Resource Group for PMG	2011		2012		2013		2014		2015		2016		2017	
								1st Half	2nd Half	1st Half	2nd Half	1st Half	2nd Half	1st Half	2nd Half	1st Half	2nd Half	1st Half	2nd Half	1st Half	2nd Half
336	536200	Confirm comprehensiveness to start feasibility assessment	◆	0d	Thu 15/12/11	Thu 15/12/11	CSDs,CBs			◆	13/12/2011										
337	212100	<b>Synchronization Point [SP 1 - Start Feasibility Confirmed]</b>	◆	0d	Tue 20/12/11	Tue 20/12/11	Eurosystem,CSDs,CBs			◆	20/12/2011										
338	260100	<b>Graphical User Interface (GUI)</b>		535d	Fri 17/02/10	Thu 01/03/12	Eurosystem,CSDs,CBs														
358	281100	[Deliverable] - Graphical User Interface (GUI) Business Functionalities	◆	0d	Mon 28/02/11	Mon 28/02/11	Eurosystem			◆	28/02/2011										
359	281200	<b>GUI Screens Workshops</b>	◆	72d	Wed 02/03/11	Thu 09/06/11	Eurosystem,CSDs,CBs														
366	281800	<b>GUI Usability Workshops after STIBOS</b>		76d	Mon 07/11/11	Mon 20/02/12	Eurosystem,CSDs,CBs														
367	281850	Sixth Workshop on T2S GUI	◆	0d	Mon 07/11/11	Mon 07/11/11	Eurosystem,CSDs,CBs			◆	07/11/2011										
368	281900	Market Feedbacks on T2S GUI	◆	44d	Mon 07/11/11	Thu 05/01/12	CSDs,CBs														
369	281950	Seventh Workshop on T2S GUI	◆	0d	Mon 06/02/12	Mon 06/02/12	Eurosystem,CSDs,CBs			◆	06/02/2012										
370	282000	Market Feedbacks on T2S GUI	◆	11d	Mon 06/02/12	Mon 20/02/12	CSDs,CBs														
373	282200	<b>DOCUMENTATION</b>		1045d	Tue 04/05/10	Mon 19/05/14															
374	252100	<b>T2S Smooth Cross CSD settlement</b>		305d	Tue 04/05/10	Fri 01/07/11															
378	253200	<b>1st Mini-consultation</b>	◆	89d	Wed 08/09/10	Fri 07/01/11															
391	257275	<b>2nd Mini-consultation</b>	◆	55d	Tue 30/11/10	Fri 11/02/11															
405	257500	Preparation of final deliverable of smooth cross-CSD settlement in T2S	◆	89d	Mon 28/02/11	Thu 30/06/11	TF														
411	259100	[Deliverable] - T2S Smooth Cross CSD settlement Report V1.0	◆	0d	Thu 30/06/11	Thu 30/06/11	Eurosystem			◆	30/06/2011										
412	259200	<b>Adaptation to Cross CSD settlement</b>	◆	369d	Fri 01/07/11	Thu 29/11/12															
413	259300	<b>Task Force Activities/Meetings</b>		369d	Fri 01/07/11	Thu 29/11/12															
416	259600	1st Task Force meeting	◆	1d	Wed 07/09/11	Wed 07/09/11	TF														
418	259800	Mini-consultation 1	◆	64d	Wed 01/02/12	Mon 30/04/12	TF														
420	260000	Mini-consultation 2	◆	64d	Wed 02/05/12	Mon 30/07/12	TF														
428	261600	<b>Preparation of Adaptation to T2S Cross CSD settlement</b>	◆	313d	Thu 08/09/11	Tue 20/11/12															
430	261900	Final Delivery of the TF Report to the AG	◆	0d	Tue 20/11/12	Tue 20/11/12	Eurosystem														
431	262000	[Deliverable] - Adaptation to Cross CSD settlement Report	◆	0d	Tue 20/11/12	Tue 20/11/12	Eurosystem														
432	224200	<b>Business Process Description (BPD)</b>		389d	Tue 25/05/10	Fri 18/11/11															
445	225150	<b>BPD V0.1</b>		198d	Fri 30/07/10	Mon 02/05/11															
465	225550	<b>BPD V1.0</b>		122d	Wed 01/06/11	Fri 18/11/11															
466	227300	<b>On going process of reviewing Business Process Description with the Market</b>		101d	Wed 01/06/11	Wed 19/10/11															
467	227400	<b>First Phase: Production of Business Process Description V0.3</b>		56d	Wed 01/06/11	Wed 17/08/11															
475	228600	<b>Second Phase: Production of Business Process Description V1.0 (including V0.3 &amp; V0.4)</b>		45d	Wed 17/08/11	Wed 19/10/11															
486	230000	[Deliverable] - Business Process Description V 1.0 (BPD)	◆	0d	Fri 18/11/11	Fri 18/11/11	Eurosystem														

Task [ ] Milestone [◆] Critical Milestone [◆] Critical Task [ ] Project Summary [ ] Group By Summary [ ]

T2S Operational Plan with Critical Path  
31/10/2011

ID	ID Number (Number 1)	Task Name	CSD/CB relevant activities	Duration	Start	Finish	Resource Group for PMG	2011		2012		2013		2014		2015		2016		2017	
								1st Half	2nd Half	1st Half	2nd Half	1st Half	2nd Half	1st Half	2nd Half	1st Half	2nd Half	1st Half	2nd Half	1st Half	2nd Half
487	304100	User Handbook (UHB)		661d	Mon 28/02/11	Tue 17/09/13															
488	311100	User Handbook V1.0		475d	Mon 28/02/11	Thu 27/12/12	Eurosystem														
505	324100	[Deliverable] - User Hand Book (UHB) V1.0		0d	Thu 27/12/12	Thu 27/12/12	Eurosystem														
506	325100	User Handbook V 2.0		77d	Mon 03/06/13	Tue 17/09/13	Eurosystem														
517	335200	[Deliverable] - User Hand Book V2.0 (UHB)		0d	Tue 17/09/13	Tue 17/09/13	Eurosystem														
518	34101	T2S Glossary		353d	Wed 02/01/13	Mon 19/05/14															
519	34114	Internal Eurosystem Preparation [T2S Glossary]		347d	Wed 02/01/13	Fri 09/05/14															
532	35100	[Deliverable] - T2S Glossary V1.0		0d	Mon 19/05/14	Mon 19/05/14	Eurosystem														
533	414300	DEVELOPMENT		1615d	Tue 01/04/08	Mon 30/06/14															
534	414400	SOFTWARE AND 4CB TESTING		1232d	Wed 01/04/09	Mon 30/12/13															
541	339100	Application Development & Internal Testing		1232d	Wed 01/04/09	Mon 30/12/13															
543	351130	Development Process - M2 - UDFS/IDFS stabilised and integrated in the development process iterations		0d	Fri 01/04/11	Fri 01/04/11	Eurosystem														
544	351130	Development process - M3 - Interfaces specifications frozen (UDFS/GUJ); Iteration 5 technically integrated and tested		0d	Mon 31/10/11	Mon 31/10/11	Eurosystem														
545	354130	Development Process - M4 - Start of 4CB JAC		0d	Mon 02/04/12	Mon 02/04/12	Eurosystem														
546	355140	Development process - M5 - Technical stability		0d	Fri 28/09/12	Fri 28/09/12	Eurosystem														
547	361101	Development process - M6 - Functional stability		0d	Fri 29/03/13	Fri 29/03/13	Eurosystem														
548	339200	Development process - M7 - 4CB Internal Acceptance check point - Progress status		0d	Mon 30/09/13	Mon 30/09/13	Eurosystem														
559	350100	Iteration 3		197d	Thu 01/07/10	Thu 31/03/11															
563	351100	Iteration 4		196d	Fri 01/10/10	Thu 30/06/11															
568	352100	Iteration 5		195d	Mon 03/01/11	Fri 30/09/11															
573	353100	Iteration 6		261d	Fri 01/04/11	Fri 30/03/12															
579	354100	Iteration 7		261d	Fri 01/07/11	Fri 29/06/12															
585	355100	Iteration 8		260d	Mon 03/10/11	Fri 28/09/12															
591	356100	Iteration 9		257d	Mon 02/01/12	Fri 28/12/12															
597	357100	Iteration 10		256d	Mon 02/04/12	Mon 01/04/13															
603	365200	Iteration 11		332d	Mon 02/07/12	Wed 16/10/13															
617	369700	Iteration 12		318d	Mon 01/10/12	Mon 30/12/13															
622	370100	INFRASTRUCTURE		1615d	Tue 01/04/08	Mon 23/06/14															
633	377150	4CB - Infrastructure Test		550d	Mon 30/04/12	Mon 23/06/14															
634	377155	Preparation Non functional test cases		257d	Mon 30/04/12	Tue 30/04/13															
641	377650	Exchanges with the market (non functional test cases)		40d	Mon 23/07/12	Fri 14/09/12	Eurosystem,CSOs,CBs														

Task Critical Milestone Critical Milestone Critical Task Milestone Project Summary Group By Summary

T2S Operational Plan with Critical Path  
31/10/2011

ID	ID Number (Number 1)	Task Name	CSD/CB relevant activities	Duration	Start	Finish	Resource Group for PMG	2011		2012		2013		2014		2015		2016		2017		
								1st Half	2nd Half	1st Half	2nd Half	1st Half	2nd Half	1st Half	2nd Half	1st Half	2nd Half	1st Half	2nd Half	1st Half	2nd Half	
								Qtr.1	Qtr.2	Qtr.3	Qtr.4	Qtr.1	Qtr.2	Qtr.3	Qtr.4	Qtr.1	Qtr.2	Qtr.3	Qtr.4	Qtr.1	Qtr.2	
648	380110	[Deliverable] - T2S Non-functional Testing Scenarios	◆	0d	Wed 02/09/13	Wed 02/09/13	Eurosystem															
651	380300	<b>Execution Non functional test cases</b>		214d	<b>Tue 30/04/13</b>	<b>Mon 03/03/14</b>																
652	378101	Start Execution Infrastructure test		0d	Tue 30/04/13	Tue 30/04/13	Eurosystem															
659	386100	[Deliverable] - Non Functional Testing Report	◆	0d	Fri 29/02/14	Fri 29/02/14	Eurosystem															
664	388100	<b>EUROSYSTEM ACCEPTANCE TEST</b>		1225d	<b>Mon 03/01/11</b>	<b>Fri 02/10/15</b>																
665	389200	<b>EAT PREPARATION</b>		1225d	<b>Mon 03/01/11</b>	<b>Fri 02/10/15</b>																
983	451300	[Deliverable] - CSDs Market specific test cases for EAT V1.0	◆	0d	Thu 17/10/13	Thu 17/10/13	CSDs															
984	451700	[Deliverable] - CBs Market specific test cases for EAT V1.0	◆	0d	Thu 17/10/13	Thu 17/10/13	CBs															
1045	451400	[Deliverable] - EAT Documentation V1.0 (EAT Test Sebs)		0d	Thu 14/11/13	Thu 14/11/13	Eurosystem															
1071	482300	<b>EAT EXECUTION</b>		265d	<b>Mon 02/12/13</b>	<b>Mon 15/12/14</b>																
1074	485100	<b>Execution Phase EAT Critical</b>		236d	<b>Wed 15/01/14</b>	<b>Fri 12/12/14</b>																
1075	464150	<b>Synchronization Point [SP5: Start of Eurosystem Acceptance Test]</b>		0d	Wed 15/01/14	Wed 15/01/14	Eurosystem															
1076	468120	Start EAT - Eurosystem Acceptance Test (following the Entry Criteria)		0d	Wed 15/01/14	Wed 15/01/14	Eurosystem															
1089	493130	[Deliverable] EAT Assessment Report	◆	0d	Mon 01/09/14	Mon 01/09/14	Eurosystem															
1090	493160	Go-no go decision with CSDs to start the User Testing	◆	0d	Mon 15/09/14	Mon 15/09/14	T2SPB															
1094	498100	<b>EAT Status update (recurrent task during EAT phase until 1 month prior the start of UT)</b>		23d	<b>Wed 12/02/14</b>	<b>Fri 14/03/14</b>																
1099	451800	[Deliverable] - EAT Status update (recurrent task)	◆	0d	Fri 14/03/14	Fri 14/03/14	Eurosystem															
1194	524100	<b>CLIENT READINESS</b>		2134d	<b>Mon 17/11/08</b>	<b>Mon 30/01/17</b>																
1195	524200	<b>SYNCHRONISATION AND ON-BOARDING</b>		2134d	<b>Mon 17/11/08</b>	<b>Mon 30/01/17</b>																
1196	534200	<b>CSD READINESS</b>		1950d	<b>Fri 31/07/09</b>	<b>Mon 30/01/17</b>																
1275	536000	<b>CSDs Feasibility Assessment</b>		280d	<b>Mon 21/11/11</b>	<b>Mon 17/12/12</b>																
1276	536100	Preparation of impact assessment and adaptation plan by CSDs	◆	160d	Mon 21/11/11	Fri 29/06/12	CSDs															
1277	213100	[Deliverable] - CSD Feasibility Assessment	◆	0d	Fri 29/06/12	Fri 29/06/12	CSDs															
1281	214100	<b>Synchronization Point [SP2 - Feasibility Confirmation by CSD/08]</b>	◆	0d	Fri 10/08/12	Fri 10/08/12	Eurosystem															
1284	553000	Update on CSD Feasibility Assessment	◆	0d	Mon 17/12/12	Mon 17/12/12	CSDs															
1285	553100	<b>Synchronisation Point [SP3 - T2S Programme Plan Comprehensiveness]</b>	◆	0d	Mon 17/12/12	Mon 17/12/12	Eurosystem,CSD															
1546	625200	<b>Proof of Eligibility to Participate in T2S (Wave 1)</b>		67d	<b>Mon 10/11/14</b>	<b>Mon 16/02/15</b>																
1553	625600	[Deliverable] - Proof of Eligibility to Participate in T2S (Wave 1)	◆	0d	Mon 19/01/15	Mon 19/01/15	CSDs															
1556	625900	<b>Proof of Eligibility to Participate in T2S (Wave 2)</b>		67d	<b>Mon 13/07/15</b>	<b>Tue 13/10/15</b>																
1563	626700	[Deliverable] - Proof of Eligibility to Participate in T2S (Wave 2)	◆	0d	Tue 15/09/15	Tue 15/09/15	CSDs															
1566	627000	<b>Proof of Eligibility to Participate in T2S (Wave 3)</b>		67d	<b>Fri 01/01/16</b>	<b>Tue 29/03/16</b>																

Task  Critical Milestone  Milestone  Critical Task  Project Summary  Group By Summary

T2S Operational Plan with Critical Path

31/10/2011

ID	ID Number (Number 1)	Task Name	CSD/CB relevant activities	Duration	Start	Finish	Resource Group for PMG	2011		2012		2013		2014		2015		2016		2017	
								1st Half	2nd Half	1st Half	2nd Half	1st Half	2nd Half	1st Half	2nd Half	1st Half	2nd Half	1st Half	2nd Half	1st Half	2nd Half
1573	628000	[Deliverable] - Proof of Eligibility to Participate in T2S (Wave 3)		0d	Thu 03/03/16	Thu 03/03/16	CSDs														
1576	544100	<b>CB READINESS</b>		882d	Fri 31/07/09	Mon 17/12/12															
1581	536300	<b>CBs Feasibility Assessment</b>		280d	Mon 21/11/11	Mon 17/12/12															
1582	536310	Preparation of impact assessment and adaptation plan by CBs		160d	Mon 21/11/11	Fri 29/06/12	CBs														
1583	546500	[Deliverable] - CB Feasibility Assessment		0d	Fri 29/06/12	Fri 29/06/12	CBs														
1587	546600	<b>Synchronization Point [SP2 - Feasibility Confirmation by CSD/CB]</b>		0d	Fri 10/08/12	Fri 10/08/12	Eurosystem														
1590	553200	Update on CB Feasibility Assessment		0d	Mon 17/12/12	Mon 17/12/12	CBs														
1591	546800	<b>Synchronisation Point [SP3 - T2S Programme Plan Comprehensiveness]</b>		0d	Mon 17/12/12	Mon 17/12/12	Eurosystem,CB														
1633	516600	<b>USER TRAINING AND TESTING</b>		1953d	Fri 02/01/09	Wed 13/07/16															
1634	555100	<b>TRAINING PREPARATION</b>		1119d	Mon 02/08/10	Mon 01/12/14															
1635	556100	<b>Preparation of the T2S Training Framework</b>		480d	Mon 02/08/10	Thu 31/05/12															
1645	558100	<b>Training Framework Phase</b>		436d	Thu 30/09/10	Thu 31/05/12															
1654	559700	<b>Consultation of Public Training Framework V0.1 with CSDs and CBs</b>		35d	Mon 16/01/12	Fri 02/03/12															
1655	559800	Delivery of Public Training Framework V0.1 to the CSDs and CBs for advice		0d	Mon 16/01/12	Mon 16/01/12	Eurosystem														
1656	559900	Feedback from CSDs and CBs on Public Training Framework V0.1		20d	Mon 16/01/12	Fri 10/02/12	CSDs,CBs														
1658	556500	Workshop with CSDs and CBs on Public Training Framework V0.1 (in case of need)		1d	Fri 02/03/12	Fri 02/03/12	ECB,4CB,CSDs,CBs														
1668	562100	[Deliverable] - T2S Public Training Framework V1.0		0d	Thu 31/05/12	Thu 31/05/12	Eurosystem														
1678	563100	<b>Training Materials preparation</b>		603d	Mon 23/07/12	Mon 01/12/14															
1685	566400	Publication of T2S Training Calendar		0d	Mon 17/12/12	Mon 17/12/12	Eurosystem														
1686	566500	<b>Internal Eurosystem Preparation [Training Materials]</b>		540d	Fri 28/09/12	Mon 10/11/14															
1700	568100	[Deliverable] - Basic Training Materials		0d	Mon 03/06/13	Mon 03/06/13	Eurosystem														
1702	568400	[Deliverable] - Technical Training Materials		0d	Tue 03/09/13	Tue 03/09/13	Eurosystem														
1704	568600	[Deliverable] - Functional Training Materials		0d	Tue 03/12/13	Tue 03/12/13	Eurosystem														
1706	568800	[Deliverable] - Operational Training Materials		0d	Fri 20/06/14	Fri 20/06/14	Eurosystem														
1708	569000	[Deliverable] - Testing Training Materials		0d	Tue 03/06/14	Tue 03/06/14	Eurosystem														
1710	569200	[Deliverable] - Migration Training Materials		0d	Mon 01/12/14	Mon 01/12/14	Eurosystem														
1711	574200	<b>TRAINING EXECUTION</b>		786d	Mon 01/07/13	Wed 13/07/16															
1712	575100	<b>Training Session</b>		471d	Mon 01/07/13	Wed 06/05/15															
1713	575101	Start training session		0d	Mon 01/07/13	Mon 01/07/13	Eurosystem,CSDs,CBs														
1721	580150	CSDs and CBs training sessions finalised before wave 1		0d	Wed 06/05/15	Wed 06/05/15	Eurosystem,CSDs,CBs														
1722	581100	<b>Refresh-training before go-live</b>		300d	Thu 28/05/15	Wed 13/07/16															

Task [ ] Task [ ] Critical Milestone [ ] Milestone [ ] Critical Task [ ] Project Summary [ ] Group By Summary [ ]

T2S Operational Plan with Critical Path

ID	ID Number (Number 1)	Task Name	CSD/CB relevant activities	Duration	Start	Finish	Resource Group for PMG	2011		2012		2013		2014		2015		2016		2017	
								1st Half	2nd Half	1st Half	2nd Half	1st Half	2nd Half	1st Half	2nd Half	1st Half	2nd Half	1st Half	2nd Half	1st Half	2nd Half
1726	583100	USER TESTING PREPARATION		1465d	Fri 02/01/09	Wed 27/08/14															
1734	592200	T2S User Testing Calendar		224d	Mon 29/04/13	Thu 13/03/14															
1735	592300	Internal Eurosystem Preparation [T2S User Testing Calendar]		90d	Mon 29/04/13	Fri 30/08/13															
1739	593400	Market consultation on T2S User Testing calendar		134d	Mon 02/09/13	Thu 13/03/14															
1756	592300	[Deliverable] - User Testing Calendar		0d	Thu 13/03/14	Thu 13/03/14	Eurosystem														
1757	616200	Certification Test Sets		334d	Fri 01/03/13	Thu 19/06/14															
1758	616300	Internal Eurosystem Preparation [Certification Test Sets]		334d	Fri 01/03/13	Thu 19/06/14															
1762	616540	Market Consultation/Information on Certification test sets		164d	Mon 28/10/13	Thu 19/06/14															
1780	634600	[Deliverable] - CSD Certification Test Cases		0d	Thu 19/06/14	Thu 19/06/14	Eurosystem														
1781	634700	[Deliverable] - CB Certification Test Cases		0d	Thu 19/06/14	Thu 19/06/14	Eurosystem														
1782	634800	[Deliverable] - DCP Certification Test Cases		0d	Thu 19/06/14	Thu 19/06/14	Eurosystem														
1807	603100	UT Registration Guide		284d	Mon 04/03/13	Fri 11/04/14															
1808	603200	Internal Eurosystem Preparation [UT Registration Guide]		100d	Mon 04/03/13	Fri 19/07/13															
1812	606140	Market information on UT Registration Guide		128d	Mon 22/07/13	Wed 22/01/14															
1827	607200	[Deliverable] - Registration Guide for User Testing		0d	Wed 22/01/14	Wed 22/01/14	Eurosystem														
1828	627100	Completed UT Registration Guide for User Testing (network registration)		0d	Fri 11/04/14	Fri 11/04/14	CSDs,CBs														
1829	611100	User Testing Guide		283d	Mon 04/02/13	Wed 12/03/14															
1830	611200	Internal Eurosystem Preparation [User Testing Guide]		150d	Mon 04/02/13	Fri 30/08/13															
1834	612240	Market consultation on User Testing Guide		133d	Mon 02/09/13	Wed 12/03/14															
1849	616100	[Deliverable] - User Testing Guide		0d	Wed 12/03/14	Wed 12/03/14	Eurosystem														
1855	630100	UT Environment Preparation		20d	Wed 11/06/14	Tue 08/07/14															
1869	634200	UT environment ready		0d	Wed 11/06/14	Wed 11/06/14	Eurosystem														
1870	634300	Delivery updated version of the EAT Status update		0d	Wed 27/08/14	Wed 27/08/14	Eurosystem														
1871	497100	Synchronization Point [SP6 - Eurosystem Ready for User Testing]		0d	Tue 02/09/14	Tue 02/09/14	Eurosystem														
1879	636100	USER TESTING EXECUTION		517d	Mon 07/07/14	Wed 29/06/16															
1880	645100	Synchronization Point [SP7 - Start Connectivity Testing]		0d	Mon 07/07/14	Mon 07/07/14	Eurosystem,CSDs,CBs														
1881	645150	Connectivity Testing for interoperability wave 1		82d	Mon 07/07/14	Wed 29/10/14															
1886	646160	[Deliverable] - User Testing Stage Report (Wave 1) V1.0 [Connectivity phase]		0d	Tue 30/09/14	Tue 30/09/14	Eurosystem														
1890	649200	Synchronization Point [SP8 - Start Bilateral Interoperability Testing]		0d	Wed 01/10/14	Wed 01/10/14	Eurosystem,CSDs,CBs														
1891	649250	Acceptance Phase		126d	Thu 02/10/14	Thu 02/04/15															
1892	647200	CSD Acceptance phase wave 1		60d	Thu 02/10/14	Mon 29/12/14															

Task Critical Milestone Critical Task Milestone Project Summary Group By Summary

T2S Operational Plan with Critical Path

31/10/2011

ID	ID Number (Number 1)	Task Name	CSD/CB relevant activities	Duration	Start	Finish	Resource Group for PMG	2011		2012		2013		2014		2015		2016		2017	
								1st Half	2nd Half	1st Half	2nd Half	1st Half	2nd Half	1st Half	2nd Half	1st Half	2nd Half	1st Half	2nd Half	1st Half	2nd Half
1896	649000	CB Acceptance phase wave 1	◆	60d	Thu 02/10/14	Mon 29/12/14															
1900	647350	CSD Acceptance phase wave 2	◆	126d	Thu 02/10/14	Thu 02/04/15															
1904	649300	CB Acceptance phase wave 2	◆	126d	Thu 02/10/14	Thu 02/04/15															
1908	647450	CSD Acceptance phase wave 3	◆	126d	Thu 02/10/14	Thu 02/04/15															
1912	649700	CB Acceptance phase wave 3	◆	126d	Thu 02/10/14	Thu 02/04/15															
1916	647550	Certification Phase		184d	Thu 02/10/14	Mon 22/06/15															
1917	647600	CSD Certification phase wave 1	◆	60d	Thu 02/10/14	Mon 29/12/14															
1921	647890	CB Certification phase wave 1	◆	60d	Thu 02/10/14	Mon 29/12/14															
1925	647990	CSD Certification phase wave 2	◆	125d	Thu 02/10/14	Wed 01/04/15															
1929	648290	CB Certification phase wave 2	◆	125d	Thu 02/10/14	Wed 01/04/15															
1933	648390	CSD Certification phase wave 3	◆	184d	Thu 02/10/14	Mon 22/06/15															
1937	648590	CB Certification phase wave 3	◆	184d	Thu 02/10/14	Mon 22/06/15															
1941	650100	Interoperability - Community - Business Day Testing Wave 1		447d	Mon 01/09/14	Wed 18/05/16															
1942	652100	Interoperability Bilateral Testing Wave 1		55d	Wed 01/10/14	Thu 18/12/14															
2001	714280	[Deliverable] - User Testing Stage Report (Wave 1) V1.1 [Interoperability Bilateral phase]	◆	0d	Thu 18/12/14	Thu 18/12/14	Eurosystem														
2002	714300	Synchronization Point [SP9.1 - Start Multilateral Interoperability Testing (wave 1)]	◆	0d	Mon 29/12/14	Mon 29/12/14	Eurosystem,CSDs,CBs														
2003	722000	Interoperability Multilateral testing Wave 1	◆	45d	Tue 30/12/14	Wed 04/03/15															
2007	723100	[Deliverable] - User Testing Stage Report (Wave 1) V1.2 [Interoperability Multilateral phase]	◆	0d	Wed 04/03/15	Wed 04/03/15	Eurosystem														
2040	726400	Connectivity Testing for Migration wave 1		42d	Mon 01/09/14	Wed 29/10/14															
2044	726800	Migration Wave 1	◆	100d	Wed 03/09/14	Tue 27/01/15															
2053	730100	Synchronization Point [SP10.1 - Start Community Testing Wave 1]	◆	0d	Wed 04/03/15	Wed 04/03/15	Eurosystem,CSDs,CBs														
2054	730200	Connectivity Testing for Community wave 1		20d	Thu 05/02/15	Wed 04/03/15															
2057	731100	Community testing Wave 1	◆	50d	Wed 04/03/15	Thu 14/05/15															
2120	789400	[Deliverable] - User Testing Stage Report (Wave 1) V1.3 [Community phase]	◆	0d	Thu 14/05/15	Thu 14/05/15	Eurosystem														
2121	789500	DCP-DCAH Certification phase wave 1	◆	30d	Thu 05/03/15	Wed 15/04/15															
2124	789800	[Deliverable] - Certification report for DCPs (Wave 1)	◆	0d	Wed 15/04/15	Wed 15/04/15	Eurosystem														
2127	792000	[Deliverable] - Certification report for DCAH (Wave 1)	◆	0d	Wed 15/04/15	Wed 15/04/15	Eurosystem														
2128	796000	Synchronization Point [SP11.1 - Start Business Day Testing Wave 1]	◆	0d	Mon 18/05/15	Mon 18/05/15	Eurosystem,CSDs,CBs														
2129	796100	Business day test Wave 1	◆	19d	Mon 18/05/15	Fri 12/06/15															
2153	832300	[Deliverable] - User Testing Stage Report (Wave 1) V1.4 [Business day phase]	◆	0d	Fri 12/06/15	Fri 12/06/15	Eurosystem														
2154	832400	Progress Report Wave 1 (recurrent task during UT phase until End of User Testing Wave 1)	◆	10d	Fri 28/11/14	Thu 11/12/14															

Task      Task      Task      Critical Milestone      Milestone      Critical Task      Project Summary      Group By Summary

T2S Operational Plan with Critical Path

ID	ID Number (Number 1)	Task Name	CSD/CB relevant activities	Duration	Start	Finish	Resource Group for PMG	2011		2012		2013		2014		2015		2016		2017		
								1st Half	2nd Half	1st Half	2nd Half	1st Half	2nd Half	1st Half	2nd Half	1st Half	2nd Half	1st Half	2nd Half	1st Half	2nd Half	1st Half
								Qtr. 1	Qtr. 2	Qtr. 3	Qtr. 4	Qtr. 1	Qtr. 2	Qtr. 3	Qtr. 4	Qtr. 1	Qtr. 2	Qtr. 3	Qtr. 4	Qtr. 1	Qtr. 2	
2156	832600	[Deliverable] - Progress Report Wave 1		0d	Thu 11/22/14	Thu 11/12/14	CSDs,CBs															
2157	836100	Support Testing for other waves		258d	Mon 01/06/15	Wed 18/05/16																
2160	833100	Synchronization Point [SP12.1 - End of User Testing Execution Phase Wave 1]		0d	Mon 15/06/15	Mon 15/06/15	Eurosystem,CSDs,CBs															
2161	840100	Interoperability - Community - Business Day Testing Wave 2		487d	Mon 07/07/14	Wed 18/05/16																
2162	840200	Connectivity Testing for Interoperability wave 2		82d	Mon 07/07/14	Wed 29/10/14																
2167	840560	[Deliverable] - User Testing Stage Report (Wave 2) V2.0 [Connectivity phase]		0d	Fri 26/09/14	Fri 26/09/14	Eurosystem															
2168	842100	Interoperability Bilateral testing Waves 2		115d	Wed 01/10/14	Wed 18/03/15																
2227	914180	[Deliverable] - User Testing Stage Report (Wave 2) V2.1 [Interoperability Bilateral phase]		0d	Wed 18/03/15	Wed 18/03/15	Eurosystem															
2228	913000	Synchronization Point [SP9.2 - Start Multilateral Interoperability Testing (Wave 2)]		0d	Thu 02/04/15	Thu 02/04/15	Eurosystem,CSDs,CBs															
2229	911000	Interoperability Multilateral testing Wave 2		40d	Fri 03/04/15	Fri 29/05/15																
2233	913100	[Deliverable] - User Testing Stage Report (Wave 2) V2.2 [Interoperability Multilateral phase]		0d	Fri 29/05/15	Fri 29/05/15	Eurosystem															
2266	917300	Connectivity Testing for Migration wave 2		42d	Wed 01/10/14	Fri 28/11/14																
2270	917700	Migration Wave 2		150d	Mon 06/10/14	Fri 08/05/15																
2280	920100	Synchronization Point [SP10.2 - Start Community Testing Wave 2]		0d	Fri 29/05/15	Fri 29/05/15	Eurosystem,CSDs,CBs															
2281	920200	Connectivity Testing for Community wave 2		40d	Fri 03/04/15	Fri 29/05/15																
2284	922100	Community Testing Wave 2		115d	Fri 29/05/15	Wed 04/11/15																
2347	979300	[Deliverable] - User Testing Stage Report (Wave 2) V2.3 [Community phase]		0d	Wed 04/11/15	Wed 04/11/15	Eurosystem															
2348	979400	DCP-DCAH Certification phase wave 2		65d	Thu 09/07/15	Wed 07/10/15																
2351	979700	[Deliverable] - Certification report for DCPs (Wave 2)		0d	Wed 07/10/15	Wed 07/10/15	Eurosystem															
2354	981000	[Deliverable] - Certification report for DCAH (Wave 2)		0d	Wed 07/10/15	Wed 07/10/15	Eurosystem															
2355	102400	Synchronization Point [SP11.2 - Start Business Day Testing Wave 2]		0d	Mon 09/11/15	Mon 09/11/15	Eurosystem,CSDs,CBs															
2356	986100	Business day test Wave 2		44d	Mon 09/11/15	Mon 11/01/16																
2380	1022300	[Deliverable] - User Testing Stage Report (Wave 2) V2.4 [Business day phase]		0d	Mon 11/01/16	Mon 11/01/16	Eurosystem															
2381	1022500	Progress Report Wave 2 (recurrent task during UT phase End of User Testing Wave 2)		10d	Fri 28/11/14	Thu 11/12/14																
2383	1022700	[Deliverable] - Progress Report Wave 2 (recurrent task)		0d	Thu 11/12/14	Thu 11/12/14	CSDs,CBs															
2384	1022800	Support Testing for other waves		319d	Thu 05/03/15	Wed 18/05/16																
2387	1023100	Synchronization Point [SP12.2 - End of User Testing Execution Phase Wave 2]		0d	Mon 18/01/16	Mon 18/01/16	Eurosystem,CSDs,CBs															
2388	2200000	Interoperability - Community - Business Day Testing Wave 3		517d	Mon 07/07/14	Wed 29/06/16																
2389	2200100	Connectivity Testing for Interoperability wave 3		82d	Mon 07/07/14	Wed 29/10/14																
2394	2200600	[Deliverable] - User Testing Stage Report (Wave 3) V2.0 [Connectivity phase]		0d	Tue 30/09/14	Tue 30/09/14	Eurosystem															
2395	2201000	Interoperability Bilateral testing Wave 3		185d	Wed 01/10/14	Tue 23/06/15																

Task Critical Milestone Critical Task Project Summary Group By Summary



T2S Operational Plan with Critical Path

31/10/2011

ID	ID Number (Number 1)	Task Name	CSD/CB relevant activities	Duration	Start	Finish	Resource Group for PMG	2011		2012		2013		2014		2015		2016		2017	
								1st Half	2nd Half	1st Half	2nd Half	1st Half	2nd Half	1st Half	2nd Half	1st Half	2nd Half	1st Half	2nd Half	1st Half	2nd Half
2457	2273080	[Deliverable] - User Testing Stage Report (Wave 3) V3.1 [Interoperability Bilateral phase]	◆	0d	Tue 23/06/15	Tue 23/06/15	Eurosystem														
2458	2273500	Synchronization Point [SP2.3 - Start Multilateral Interoperability Testing (wave 3)]	◆	0d	Tue 23/06/15	Tue 23/06/15	Eurosystem,CSDs,CBs														
2459	2273100	Interoperability Multilateral Testing Wave 3	◆	93d	Wed 24/06/15	Fri 30/10/15	Eurosystem,CSDs,CBs														
2463	2275000	[Deliverable] - User Testing Stage Report(Wave 3) V3.2 [Interoperability Multilateral phase]	◆	0d	Fri 30/10/15	Fri 30/10/15	Eurosystem														
2496	2282050	Connectivity Testing for Migration wave 3	◆	40d	Fri 10/04/15	Fri 05/06/15	Eurosystem														
2500	2282400	Migration Wave 3	◆	148d	Fri 17/04/15	Mon 09/11/15	Eurosystem,CSDs,CBs														
2510	2284000	Synchronization Point [SP.10.3 - Start Community Testing Wave 3]	◆	0d	Mon 09/11/15	Mon 09/11/15	Eurosystem,CSDs,CBs														
2511	2284100	Connectivity Testing for Community wave 3	◆	40d	Tue 13/10/15	Mon 07/12/15	Eurosystem														
2514	2285000	Community testing Wave 3	◆	125d	Mon 09/11/15	Wed 27/04/16	Eurosystem														
2577	2345100	[Deliverable] - User Testing Stage Report (Wave 3) V3.3 [Community phase]	◆	0d	Wed 27/04/16	Wed 27/04/16	Eurosystem														
2578	2346000	DCP-DCAH Certification phase wave 3	◆	135d	Tue 22/12/15	Wed 22/06/16	Eurosystem														
2581	2346300	[Deliverable] - Certification report for DCPs (Wave 3)	◆	0d	Fri 18/03/16	Fri 18/03/16	Eurosystem														
2584	2346700	[Deliverable] - Certification report for DCAH (Wave 3)	◆	0d	Fri 18/03/16	Fri 18/03/16	Eurosystem														
2585	2351100	Synchronization Point [SP11.3 - Start Business Day Testing Wave 3]	◆	0d	Wed 27/04/16	Wed 27/04/16	Eurosystem,CSDs,CBs														
2586	2352000	Business day test Wave 3	◆	40d	Wed 27/04/16	Wed 22/06/16	Eurosystem														
2610	2390200	[Deliverable] - User Testing Stage Report (Wave 3) V3.4 [Business day phase]	◆	0d	Wed 22/06/16	Wed 22/06/16	Eurosystem														
2611	2391000	Progress Report Wave 3 (recurrent task during UT phase End of User Testing Wave 3)	◆	10d	Fri 28/11/14	Thu 11/12/14	Eurosystem														
2613	2391200	[Deliverable] - Progress Report Wave 3 (recurrent task)	◆	0d	Thu 11/12/14	Thu 11/12/14	CSDs,CBs														
2614	2394400	Support Testing for other waves	◆	161d	Thu 05/03/15	Wed 14/10/15	Eurosystem														
2617	2394200	Synchronization Point [SP.12.3 - End of User Testing Execution Phase Wave 3]	◆	0d	Wed 29/06/16	Wed 29/06/16	Eurosystem,CSDs,CBs														
2619	1310100	CONTRACTUAL FRAMEWORK		602d	Tue 01/09/09	Wed 31/12/11															
2748	1027100	OPERATIONAL READINESS		1984d	Mon 15/06/09	Mon 30/01/17															
2749	1027200	NETWORK AND CONNECTIVITY		1260d	Mon 15/06/09	Thu 24/04/14															
2750	1028100	NETWORK AND CONNECTIVITY		1260d	Mon 15/06/09	Thu 24/04/14															
2809	1063480	Tender process for Value-Added Services (VA-NSPs)		147d	Fri 08/07/11	Tue 31/01/12															
2811	1059100	[Deliverable] - Tender for Network Connectivity (VAN)		0d	Fri 08/07/11	Fri 08/07/11	Eurosystem														
2814	1061100	Signature of Network Service Provider Agreement		0d	Tue 31/01/12	Tue 31/01/12	Eurosystem														
2815	1062000	CSDs - Network Service Provider negotiations		543d	Tue 28/02/12	Fri 11/04/14															
2818	1063120	CSD: Network Agreement Contract signed	◆	0d	Fri 11/04/14	Fri 11/04/14	CSDs														
2821	1063190	CB: Network Agreement Contract signed	◆	0d	Fri 11/04/14	Fri 11/04/14	CBs														
2822	1060500	Tender process for Dedicated line (DL-NSPs) (to be updated after PB meeting in June)		498d	Tue 01/03/11	Thu 31/01/13	Eurosystem														

Task Critical Milestone Critical Milestone Critical Task Milestone Project Summary Group By Summary

T2S Operational Plan with Critical Path

31/10/2011

11 of 16

ID	ID Number (Number 1)	Task Name	CSD/CB relevant activities	Duration	Start	Finish	Resource Group for PMG	2011		2012		2013		2014		2015		2016		2017			
								1st Half	2nd Half	1st Half	2nd Half	1st Half	2nd Half	1st Half	2nd Half	1st Half	2nd Half	1st Half	2nd Half	1st Half	2nd Half	1st Half	2nd Half
								Qtr.1	Qtr.2	Qtr.3	Qtr.4	Qtr.1	Qtr.2	Qtr.3	Qtr.4	Qtr.1	Qtr.2	Qtr.3	Qtr.4	Qtr.1	Qtr.2	Qtr.3	Qtr.4
2829	1061000	Contract Signature for dedicated link	◆	0d	Thu 31/09/13	Thu 31/09/13	Eurosystem																
2837	1064100	Implementation Phase 2 - VAN Network		322d	Wed 01/08/12	Mon 04/11/13																	
2842	1067100	Start of VAN Networks connectivity tests with CSDs/CBs (Finish acceptance VAN Networks by 4CB)		0d	Mon 04/11/13	Mon 04/11/13	Eurosystem																
2843	1077300	Implementation - Phase 2 - Dedicated Links		196d	Fri 01/02/13	Mon 04/11/13	Eurosystem																
2847	1077700	Start of DL connectivity tests with DiGoAs		0d	Mon 04/11/13	Mon 04/11/13	Eurosystem																
2849	1037100	Implementation - Phase 3 - Network - Connectivity Guides		173d	Tue 30/04/13	Thu 02/01/14																	
2850	1038100	Internal Eurosystem Preparation [Connectivity Guide]		173d	Tue 30/04/13	Thu 02/01/14																	
2852	1042200	[Deliverable] - Connectivity Guide for VAN and Direct connectivity (Testing) V1.0	◆	0d	Tue 30/07/13	Tue 30/07/13	Eurosystem																
2855	1043100	[Deliverable] - Connectivity Guide for VAN and Direct connectivity V2.0	◆	0d	Thu 02/01/14	Thu 02/01/14	Eurosystem																
2856	1081100	INFORMATION SECURITY		1221d	Wed 01/09/10	Fri 29/05/15																	
2857	1082100	INFORMATION SECURITY		1221d	Wed 01/09/10	Fri 29/05/15																	
2858	1084280	T2S Threat Catalogue		508d	Mon 03/01/11	Thu 13/12/12																	
2859	1084290	Internal Eurosystem Preparation [T2S Threat Catalogue]		505d	Mon 03/01/11	Mon 10/12/12																	
2867	1091500	[Deliverable] - T2S Threat Catalogue		0d	Thu 13/12/12	Thu 13/12/12	Eurosystem																
2906	1107250	Risk analysis on T2S Compliance with T2S Information Security policy [Risk evaluation table & Risk treatment plan]		197d	Wed 13/08/14	Fri 22/05/15																	
2907	1107260	Internal Eurosystem Preparation [Risk analysis on T2S Compliance with T2S Information Security policy]		197d	Wed 13/08/14	Fri 22/05/15																	
2920	1108100	[Deliverable] - Risk Analysis on T2S Compliance with T2S Information Security policy	◆	0d	Fri 22/05/15	Fri 22/05/15	Eurosystem																
2932	1109200	OPERATIONS		1275d	Thu 01/12/11	Wed 02/11/16																	
2933	1110100	OPERATIONAL PROCEDURES		1275d	Thu 01/12/11	Wed 02/11/16																	
2934	1111100	Manual of Operational Procedures (MOP)		1275d	Thu 01/12/11	Wed 02/11/16																	
2935	1111150	Production MOP V1.0 (before starting User Test)		616d	Thu 01/12/11	Thu 24/04/14																	
2936	1112050	First set of review cycles		348d	Thu 01/12/11	Mon 08/04/13																	
2942	1113500	First Market consultation on Manual of Operational Procedures (MOP)	◆	198d	Thu 28/06/12	Mon 09/04/13																	
2946	1115100	Review MOP V0.1 by OMG	◆	30d	Fri 13/07/12	Thu 23/08/12	OMG																
2950	1119100	Review MOP V0.2 by OMG	◆	30d	Tue 23/10/12	Mon 03/12/12	OMG																
2963	1124000	Second set of review cycles		275d	Tue 12/03/13	Mon 07/04/14																	
2966	1124300	Second Market consultation on Manual of Operational Procedures (MOP)	◆	215d	Tue 04/06/13	Mon 07/04/14																	
2983	1140100	[Deliverable] - Manual of Operational Procedures (MOP) V1.0 for Business Day Test wave 1	◆	0d	Thu 24/04/14	Thu 24/04/14	Eurosystem																
2984	1140200	Production MOP V1.2 (revised MOP V1.0 before Start Operation in T2S wave 1)	◆	18d	Tue 19/05/15	Thu 11/06/15																	
2988	1121100	[Deliverable] - Manual of Operational Procedures (MOP) V1.2 before Start Operation in T2S Wave 1	◆	0d	Thu 11/06/15	Thu 11/06/15	Eurosystem																
2989	1121200	Production MOP V1.3 (revised MOP V1.2 after Start Operation in T2S wave 1 and during Business Day Test wave 2)	◆	121d	Tue 21/07/15	Thu 07/01/16																	

Task Milestone Critical Milestone Critical Task Project Summary Group By Summary

T2S Operational Plan with Critical Path  
31/10/2011

ID	ID Number (Number - 1)	Task Name	CSD/CB relevant activities	Duration	Start	Finish	Resource Group for PMG	2011		2012		2013		2014		2015		2016		2017		
								1st Half	2nd Half	1st Half	2nd Half	1st Half	2nd Half	1st Half	2nd Half	1st Half	2nd Half	1st Half	2nd Half			
2995	1145200	[Deliverable] - Manual of Operational Procedures (MOP) V1.3 during Business Day Test Wave 2	◆	0d	Thu 07/01/16	Thu 07/01/16	Eurosystem	Qtr 1	Qtr 2	Qtr 3	Qtr 4	Qtr 1	Qtr 2	Qtr 3	Qtr 4	Qtr 1	Qtr 2	Qtr 3	Qtr 4	1st Half	2nd Half	
2996	1145300	Production MOP V1.4 (revised MOP V1.3 after Start Operation in T2S wave 2 and during Business Day Test wave 3)	◆	50d	Thu 25/02/16	Mon 02/05/16	Eurosystem															
3002	1145800	[Deliverable] - Manual of Operational Procedures (MOP) V1.4 during Business Day Test Wave 3	◆	0d	Mon 02/05/16	Mon 02/05/16	Eurosystem															
3003	1145900	Production MOP V2.0 (Operational activities after Start Operation in T2S wave 3)	◆	97d	Thu 23/06/16	Wed 02/11/16	Eurosystem															
3009	1146050	[Deliverable] - Manual of Operational Procedures (MOP) V2.0 after start of operations in T2S of wave 3	◆	0d	Thu 23/06/16	Thu 23/06/16	Eurosystem															
3017	1110200	SERVICE LEVEL AGREEMENT	◆	0d	Fri 30/12/11	Fri 30/12/11																
3018	1187100	MIGRATION	◆	1956d	Thu 23/07/09	Mon 30/01/17																
3019	1187200	MIGRATION PREPARATION	◆	1800d	Thu 23/07/09	Thu 30/06/16																
3027	1200100	Preparation phase	◆	1337d	Mon 02/05/11	Thu 30/06/16																
3028	1201100	Processes and tools for Data Migration	◆	244d	Mon 02/05/11	Thu 05/04/12																
3029	1201200	Internal Eurosystem Preparation [Processes and tools for Data Migration]	◆	67d	Mon 02/05/11	Tue 02/08/11																
3033	1203400	Market consultation on Processes and tools for Data Migration	◆	122d	Wed 19/10/11	Thu 05/04/12																
3049	1206100	[Deliverable] - User Requirements for data migration tools V1.0	◆	0d	Thu 05/04/12	Thu 05/04/12	Eurosystem															
3050	1207100	Composition of Migration Waves & Dates	◆	116d	Fri 29/06/12	Mon 10/12/12																
3051	1207150	Reception of Proposal of migration waves: plus migration dates for each CSD/CB (as part of the feasibility study)	◆	0d	Fri 29/06/12	Fri 29/06/12	CSDs,CBs															
3052	1207200	Eurosystem consultation: review of CSDs proposal by the Eurosystem	◆	71d	Fri 29/06/12	Mon 08/10/12																
3053	1209100	Coordination by Eurosystem of proposal for the Composition of migration waves (incl. CSD/CBs views)	◆	26d	Fri 29/06/12	Fri 03/08/12	Eurosystem,CSDs,CBs															
3054	546350	[Deliverable] - Composition and Timing Migration Waves by CSDs/CBs	◆	0d	Fri 03/08/12	Fri 03/08/12	CSDs,CBs															
3055	1209130	Evaluation by Eurosystem of proposal for the timing of migration waves (incl. CSD/CBs views)	◆	40d	Mon 06/08/12	Fri 28/09/12	Eurosystem,CSDs,CBs															
3056	1209150	Confirmation of the Timing and Composition of Migration Waves by Eurosystem	◆	0d	Mon 08/10/12	Mon 08/10/12	Eurosystem															
3057	1209160	Market Consultation on Composition of Migration Waves & Dates (only whether CSDs proposal conflicts with migration criteria)	◆	96d	Fri 27/07/12	Mon 10/12/12																
3075	1218000	[Deliverable] - Confirmation of composition and timing of Migration Waves V1.0	◆	0d	Mon 10/12/12	Mon 10/12/12	Eurosystem															
3076	1218100	Migration profiles & Registration Guide	◆	289d	Mon 03/10/11	Fri 09/11/12																
3077	1218200	Internal Eurosystem Preparation [Migration profiles & Registration Guide]	◆	95d	Mon 03/10/11	Fri 10/02/12																
3080	1220400	Market Consultation on Migration profiles & Registration Guide	◆	194d	Mon 13/02/12	Fri 09/11/12																
3084	122250	Review Migration profiles & Registration Guide V0.1 by MSG	◆	15d	Tue 27/03/12	Mon 16/04/12	OMG															
3088	122850	Review Migration profiles & Registration Guide V0.2 by MSG	◆	15d	Wed 02/05/12	Tue 22/06/12	OMG															
3092	122850	Review Migration profiles & Registration Guide V0.2 by MSG	◆	15d	Thu 07/06/12	Wed 27/06/12	OMG															
3106	1222100	[Deliverable] - Registration Guide for Migration V1.0	◆	0d	Fri 09/11/12	Fri 09/11/12	Eurosystem															
3107	1228100	Standard Migration plans (including fallback and Roll-back Procedures)	◆	464d	Mon 16/01/12	Fri 01/11/13																
3108	1228200	Internal Eurosystem Preparation [Standard Migration plans (including fallback and Roll-back Procedures)]	◆	230d	Mon 16/01/12	Mon 03/12/12																

Task Critical Milestone Critical Task Milestone Project Summary Group By Summary

T2S Operational Plan with Critical Path

31/10/2011

13 of 16

ID	ID Number (Number 1)	Task Name	CSD/CB relevant activities	Duration	Start	Finish	Resource Group for PMG	2011		2012		2013		2014		2015		2016		2017
								1st Half	2nd Half	1st Half	2nd Half	1st Half	2nd Half	1st Half	2nd Half	1st Half	2nd Half	1st Half	2nd Half	
3113	1232900	Market consultation on Standard Migration plan and Roll-back Procedures	◆	234d	Tue 04/12/12	Fri 01/11/13	Eurosystem													
3143	1232800	[Deliverable] - Standard Migration Plan V1.0	◆	0d	Fri 01/11/13	Fri 01/11/13	Eurosystem													
3144	1232900	Migration Weekend Script (including Roll-back and Roll-back Procedures)	◆	797d	Mon 03/06/13	Thu 30/06/16	Eurosystem													
3145	1233000	Internal Eurosystem Preparation [Migration Weekend Script for wave 1]	◆	150d	Mon 03/06/13	Fri 03/01/14	Eurosystem													
3150	1233340	Market consultation on Migration Weekend Script	◆	230d	Mon 06/04/14	Tue 25/11/14	Eurosystem													
3176	1235400	[Deliverable] - Detailed Migration Weekend Script V1.0 Wave 1	◆	0d	Fri 28/11/14	Fri 28/11/14	Eurosystem													
3177	1235500	Review Migration Weekend Script for wave 1 before Start Operation in T2S	◆	31d	Fri 24/04/15	Mon 08/06/15	Eurosystem													
3179	1235650	Market consultation Migration Weekend Script for wave 1 before Start Operation in T2S	◆	21d	Fri 08/05/15	Mon 08/06/15	Eurosystem													
3183	1236000	[Deliverable] - Detailed Migration Weekend Script V1.2 Wave 1	◆	0d	Mon 08/06/15	Mon 08/06/15	Eurosystem													
3184	1236400	Internal Eurosystem Preparation [Migration Weekend Script for wave 2]	◆	90d	Mon 02/03/15	Thu 02/07/15	Eurosystem													
3187	1236640	Market consultation Migration Weekend Script for wave 2	◆	92d	Fri 03/07/15	Mon 09/11/15	Eurosystem													
3196	1237300	[Deliverable] - Detailed Migration Weekend Script V2.2 Wave 2	◆	0d	Mon 09/11/15	Mon 09/11/15	Eurosystem													
3197	1237350	Review Migration Weekend Script for wave 2 before Start Operation in T2S	◆	26d	Wed 09/12/15	Thu 14/01/16	Eurosystem													
3199	1237450	Market consultation Migration Weekend Script for wave 2 before Start Operation in T2S	◆	16d	Tue 22/12/15	Thu 14/01/16	Eurosystem													
3203	1236020	[Deliverable] - Detailed Migration Weekend Script V2.4 Wave 2	◆	0d	Thu 14/01/16	Thu 14/01/16	Eurosystem													
3204	1237400	Internal Eurosystem Preparation [Migration Weekend Script for wave 3]	◆	80d	Thu 20/08/15	Wed 09/12/15	Eurosystem													
3207	1237540	Market consultation on Migration Weekend Script for wave 3	◆	149d	Thu 10/12/15	Thu 30/06/16	Eurosystem													
3216	1238200	[Deliverable] - Detailed Migration Weekend Script V3.2 Wave 3	◆	0d	Tue 12/04/16	Tue 12/04/16	Eurosystem													
3217	1234650	Review Migration Weekend Script for wave 3 before Start Operation in T2S	◆	26d	Thu 26/05/16	Thu 30/06/16	Eurosystem													
3219	1235710	Market consultation Migration Weekend Script for wave 3 before Start Operation in T2S	◆	16d	Wed 08/06/16	Thu 30/06/16	Eurosystem													
3223	1236040	[Deliverable] - Detailed Migration Weekend Script V3.1 Wave 3	◆	0d	Thu 30/06/16	Thu 30/06/16	Eurosystem													
3239	1269100	PRE-MIGRATION TASKS (WAVE 1)	◆	255d	Fri 20/06/14	Fri 19/06/15	Eurosystem													
3240	1235410	Implementation Migration phase (wave 1)	◆	80d	Mon 17/11/14	Thu 12/03/15	Eurosystem													
3241	1244100	Preparation of Migration Weekend (wave 1)	◆	80d	Mon 17/11/14	Thu 12/03/15	Eurosystem													
3242	124410	Start preparation of Migration Weekend	◆	0d	Mon 01/12/14	Mon 01/12/14	Eurosystem													
3244	387100	Network ready for Production	◆	0d	Mon 01/12/14	Mon 01/12/14	Eurosystem													
3247	1247100	Registration Form filled in (wave 1 + CSDs/CBs with Common Static Data)	◆	0d	Fri 12/12/14	Fri 12/12/14	CSDs,CBs													
3248	1249100	Preparation of production environment	◆	80d	Mon 17/11/14	Thu 12/03/15	Eurosystem													
3250	1250100	Synchronization Point [SP13 - Eurosystem ready for Production]	◆	0d	Mon 01/12/14	Mon 01/12/14	Eurosystem													
3257	1257100	Synchronization Point [SP14.1 - Ready to connect to Production wave 1]	◆	0d	Thu 05/02/15	Thu 05/02/15	Eurosystem,CSDs													
3259	1263100	Successful connectivity tests CSD (wave 1)	◆	0d	Thu 12/03/15	Thu 12/03/15	CSDs													

Task Critical Milestone Critical Task Milestone Group By Summary



T2S Operational Plan with Critical Path

ID	ID Number (Number 1)	Task Name	CSD/CB relevant activities	Duration	Start	Finish	Resource Group for PMG	2011			2012			2013			2014			2015			2016			2017						
								1st Half	2nd Half	Qtr 1	Qtr 2	Qtr 3	Qtr 4	1st Half	2nd Half	Qtr 1	Qtr 2	Qtr 3	Qtr 4	1st Half	2nd Half	Qtr 1	Qtr 2	Qtr 3	Qtr 4		1st Half	2nd Half	Qtr 1	Qtr 2	Qtr 3	Qtr 4
								Qtr 1	Qtr 2	Qtr 3	Qtr 4	Qtr 1	Qtr 2	Qtr 3	Qtr 4	Qtr 1	Qtr 2	Qtr 3	Qtr 4	Qtr 1	Qtr 2	Qtr 3	Qtr 4	Qtr 1	Qtr 2		Qtr 3	Qtr 4	Qtr 1	Qtr 2	Qtr 3	Qtr 4
3353	1294600	Synchronization Point [SP14.3 - Ready to connect to Production Wave 3]	◆	0d	Tue 22/03/16	Tue 22/03/16	Eurosystem,CSDs																									
3355	1294300	Successful connectivity tests CSD (wave 3)	◆	0d	Fri 15/04/16	Fri 15/04/16	CSDs																									
3356	1294370	Successful connectivity tests CB (wave 3)	◆	0d	Fri 15/04/16	Fri 15/04/16	CBs																									
3362	1296100	Migration Proprietary Static Data (wave 3)	◆	125d	Mon 01/02/16	Mon 18/07/16	Eurosystem,CSDs																									
3367	1298200	Synchronization Point [SP15.3 - Ready to upload Static Data]	◆	0d	Fri 22/04/16	Fri 22/04/16	Eurosystem,CSDs																									
3370	1299200	MIGRATION WEEKEND (WAVE 3)	◆	83d	Fri 17/06/16	Mon 10/10/16	Eurosystem,CSDs																									
3376	1300100	Synchronization Point [SP16.3 - Ready for Migration Wave 3]	◆	0d	Fri 15/07/16	Fri 15/07/16	Eurosystem,CSDs																									
3378	1304100	Wave 3 Start Operations in T2S	◆	0d	Mon 18/07/16	Mon 18/07/16	Eurosystem,CSDs																									
3379	1304200	Migration closing phase Wave 3	◆	15d	Tue 02/08/16	Mon 22/08/16	Eurosystem																									
3382	2394000	[Deliverable] - End of Migration Report (Wave 3)	◆	0d	Mon 22/08/16	Mon 22/08/16	Eurosystem																									
3383	1309900	Closing phase	◆	60d	Tue 19/07/16	Mon 10/10/16	Eurosystem,CSDs																									
3388	1313000	Synchronization Point [SP17 - Closing of migration]	◆	0d	Mon 10/10/16	Mon 10/10/16	Eurosystem,CSDs																									
3433	1309500	TENTATIVE CONTINGENCY MIGRATION - MIGRATION WEEKEND	◆	4d	Fri 27/01/17	Mon 30/01/17	Eurosystem,CSDs																									
3434	1309600	Synchronization Point [SP16.5 - Ready for Contingency Migration Weekend]	◆	0d	Fri 27/01/17	Fri 27/01/17	Eurosystem,CSDs																									
3436	1309800	Contingency Wave Start Operations in T2S	◆	0d	Mon 30/01/17	Mon 30/01/17	Eurosystem,CSDs																									
3779	2000100	<b>PROGRAMME PLANNING &amp; MONITORING</b>		1932d	Thu 20/08/09	Fri 27/01/17																										
3848	2005100	<b>SYNCHRONISATION POINT</b>		1323d	Tue 20/12/11	Fri 27/01/17																										
3849	2006100	SP1 - Start Feasibility Confirmed	◆	0d	Tue 20/12/11	Tue 20/12/11																										
3850	2007100	SP2 - Feasibility Confirmation by CSD/CB	◆	0d	Fri 10/08/12	Fri 10/08/12																										
3851	2007200	SP3 - T2S Programme Plan Comprehensiveness	◆	0d	Mon 17/12/12	Mon 17/12/12																										
3852	2008100	SP4 - Network Service Provider Confirmed	◆	0d	Thu 24/04/14	Thu 24/04/14																										
3853	2009200	SP5 - Start of Eurosystem Acceptance Test	◆	0d	Wed 15/01/14	Wed 15/01/14																										
3854	2009100	SP6 - Eurosystem Ready for User Testing	◆	0d	Tue 02/09/14	Tue 02/09/14																										
3855	2010100	SP7 - Start Connectivity Testing	◆	0d	Mon 07/07/14	Mon 07/07/14																										
3856	2011100	SP8 - Start Bilateral Interoperability Testing	◆	0d	Wed 01/10/14	Wed 01/10/14																										
3857	2011200	SP9.1 - Start Multilateral Interoperability Testing (wave 1)	◆	0d	Mon 29/12/14	Mon 29/12/14																										
3858	2011300	SP9.2 - Start Multilateral Interoperability Testing (wave 2)	◆	0d	Thu 02/04/15	Thu 02/04/15																										
3859	2011400	SP9.3 - Start Multilateral Interoperability Testing (wave 3)	◆	0d	Tue 23/06/15	Tue 23/06/15																										
3860	2012100	SP10.1 - Start Community Testing (wave 1)	◆	0d	Wed 04/03/15	Wed 04/03/15																										
3861	2012200	SP10.2 - Start Community Testing (wave 2)	◆	0d	Fri 29/05/15	Fri 29/05/15																										

Task	Task	Critical Milestone	Critical Task	Milestone	Project Summary	Group By Summary
------	------	--------------------	---------------	-----------	-----------------	------------------

T2S Operational Plan with Critical Path

3/1/202011

16 of 16

ID	ID Number (Number 1)	Task Name	CSD/CB relevant activities	Duration	Start	Finish	Resource Group for PMG											
							2011	2012	2013	2014	2015	2016	2017					
							1st Half	2nd Half	1st Half	2nd Half	1st Half	2nd Half	1st Half	2nd Half	1st Half	2nd Half		
							Oct.1	Oct.2	Oct.1	Oct.2	Oct.1	Oct.2	Oct.1	Oct.2	Oct.1	Oct.2		
3862	2012300	SPI0.3 - Start Community Testing (wave 3)	◆	0d	Mon 09/11/15	Mon 09/11/15												
3863	2012400	SPI1.1 - Start Business Day Testing (wave 1)	◆	0d	Mon 18/05/15	Mon 18/05/15							◆					
3864	2012500	SPI1.2 - Start Business Day Testing (wave 2)	◆	0d	Mon 09/11/15	Mon 09/11/15							◆					
3865	2012600	SPI1.3 - Start Business Day Testing (wave 3)	◆	0d	Wed 27/04/16	Wed 27/04/16										◆		
3866	2013100	SPI2.1 - End of User Testing Execution Phase (wave 1)	◆	0d	Mon 15/06/15	Mon 15/06/15							◆					
3867	2013200	SPI2.2 - End of User Testing Execution Phase (wave 2)	◆	0d	Mon 18/01/16	Mon 18/01/16									◆			
3868	2013300	SPI2.3 - End of User Testing Execution Phase (wave 3)	◆	0d	Wed 29/06/16	Wed 29/06/16											◆	
3869	2014100	SPI3 - Eurosystem ready for Production	◆	0d	Mon 01/12/14	Mon 01/12/14							◆					
3870	2015100	SPI4.1 - Ready to connect to Production (wave 1)	◆	0d	Thu 05/02/15	Thu 05/02/15												
3871	2015200	SPI4.2 - Ready to connect to Production (wave 2)	◆	0d	Fri 02/10/15	Fri 02/10/15												
3872	2015300	SPI4.3 - Ready to connect to Production (wave 3)	◆	0d	Tue 22/03/16	Tue 22/03/16												
3873	2016100	SPI5.1 - Ready to upload Static Data (wave 1)	◆	0d	Thu 19/03/15	Thu 19/03/15												
3874	2016200	SPI5.2 - Ready to upload Static Data (wave 2)	◆	0d	Fri 06/11/15	Fri 06/11/15												
3875	2016300	SPI5.3 - Ready to upload Static Data (wave 3)	◆	0d	Fri 22/04/16	Fri 22/04/16												
3876	2017100	SPI6.1 - Ready for T2S Go-Live (wave 1)	◆	0d	Fri 19/06/15	Fri 19/06/15												
3877	2017200	SPI6.2 - Ready for Migration Wave 2	◆	0d	Fri 29/01/16	Fri 29/01/16												
3878	2017300	SPI6.3 - Ready for Migration Wave 3	◆	0d	Fri 15/07/16	Fri 15/07/16												
3879	2017400	SPI6.5 - Ready for Contingency Migration Weekend	◆	0d	Fri 27/01/17	Fri 27/01/17												
3880	2018300	SPI7 - Closing of migration	◆	0d	Mon 10/10/16	Mon 10/10/16												

## **CURRENCY PARTICIPATION AGREEMENT**

### **SCHEDULE 2 – ANNEX 3**

#### **T2S DETAILED PLAN**

***Disclaimer:***

Planning is an ongoing process and Annexes with planning elements are subject to change during the lifetime of a project. Planning workshops with CSDs and CBs will continue to agree on the planning for Connectivity, User Testing and Migration. Subsequent plan updates follow the process, documented in the Schedule 2, Section 7.

Annexes 2, 3, 4, 7, 8, 9 and 10 document the planning status as at 7 Nov. 2011.



T2S Detailed Plan with Critical Path

31/10/2011

ID	ID Number (Number 1)	Task Name	CSD/CB relevant activities	Duration	Start	Finish	Resource Group for PMG											
							2011	2012	2013	2014	2015	2016	2017					
							1st Half	2nd Half	1st Half	2nd Half	1st Half	2nd Half	1st Half	2nd Half	1st Half	2nd Half		
							Oct 1	Oct 2	Oct 3	Oct 4	Oct 1	Oct 2	Oct 3	Oct 4	Oct 1	Oct 2	Oct 3	Oct 4
1	100	<b>PRODUCT READINESS</b>		1945d	Tue 01/04/08	Fri 02/10/15												
2	500	<b>SPECIFICATION AND DOCUMENTATION</b>		1417d	Fri 28/11/08	Mon 19/05/14												
3	1100	<b>REQUIREMENTS</b>		692d	Thu 26/03/09	Thu 17/11/11												
27	11400	Submission CR for URD v 5.01 & 4CB cost assessment to AG	Eurosystem	0d	Wed 22/06/11	Wed 22/06/11												
28	13100	AG Meeting: Approval of CR for URD v 5.01	AG	2d	Thu 30/06/11	Fri 01/07/11												
35	16100	[Deliverable] - User Requirement Document (URD) 5.01	Eurosystem	0d	Thu 17/11/11	Thu 17/11/11												
36	18100	<b>SPECIFICATIONS</b>		1401d	Fri 28/11/08	Thu 24/04/14												
37	18200	<b>General Specification (GS)</b>		1401d	Fri 28/11/08	Thu 24/04/14												
45	26100	<b>GS v. 2.0</b>		257d	Wed 24/04/13	Thu 24/04/14												
46	26200	<b>Internal Eurosystem Preparation [General Specifications v. 2.0]</b>		215d	Mon 10/06/13	Thu 17/04/14												
55	34150	[Deliverable] - General Specification (GS) V. 2.0	Eurosystem	0d	Wed 24/04/13	Wed 24/04/13												
67	47100	<b>General Functional Specifications (GFS)</b>		1231d	Mon 19/01/09	Mon 14/10/13												
81	60100	<b>GFS 4.0 - aligned with URD 5.0</b>		347d	Tue 02/02/10	Wed 01/06/11												
99	74400	Feedback of the ECB T2S project team to the Market on GFS V4.0.13/04	Eurosystem	15d	Mon 04/04/11	Fri 22/04/11												
101	74500	Delivery GFS Note	Eurosystem	0d	Wed 01/06/11	Wed 01/06/11												
102	73400	<b>GFS 5.0</b>		139d	Tue 02/04/13	Mon 14/10/13												
103	73500	<b>Internal Eurosystem Preparation [Production of the GFS V5.0]</b>		134d	Tue 02/04/13	Mon 07/10/13												
113	88150	[Deliverable] - General Function Specification (GFS) V 5.0	Eurosystem	0d	Mon 14/10/13	Mon 14/10/13												
132	155150	<b>Internal Detailed Functional Specification (IDFS)</b>		910d	Wed 16/12/09	Tue 18/06/13												
133	156100	<b>Settlement Algorithm Objectives Document</b>		327d	Fri 15/01/10	Fri 15/04/11												
148	165100	<b>Production of IDFS</b>		910d	Wed 16/12/09	Tue 18/06/13												
156	172200	VS - Delivery IDFS V0.85 to the Development Coordination	Eurosystem	0d	Tue 15/02/11	Tue 15/02/11												
170	97100	<b>User Detailed Functional Specifications (UDFS)</b>		1300d	Thu 01/01/09	Tue 07/01/14												
182	550200	<b>Work on Messages Pillar I-III</b>		1300d	Thu 01/01/09	Tue 07/01/14												
183	105100	<b>Message standardisation</b>		1300d	Thu 01/01/09	Tue 07/01/14												
184	106100	Sub-group for Message Standardisation	SGMS	1300d	Thu 01/01/09	Tue 07/01/14												
185	107100	Monitoring of message standard development	Eurosystem	1300d	Thu 01/01/09	Tue 07/01/14												
186	108100	Participation in message standardisation market practice for (ISO's RMG and SC4, SMPG) & contributions to publications	SMPG	1300d	Thu 01/01/09	Tue 07/01/14												
194	116200	<b>Production of UDFS V1.0, V1.1, V1.2 (in line with GFS V4.0)</b>		560d	Mon 03/08/09	Fri 23/09/11												
195	116300	<b>Production of UDFS V1.0 [dialogue between T2S and T1s users and detailed msg specification]</b>		560d	Mon 03/08/09	Fri 23/09/11												
231	190500	<b>UDFS v1.0 - Messages</b>		207.75d	Thu 01/04/10	Fri 14/01/11												

Task Critical Milestone Critical Task Milestone Project Summary Group By Summary

T2S Detailed Plan with Critical Path

31/10/2011

ID	ID Number (Number 1)	Task Name	CSD/CB relevant activities	Duration	Start	Finish	Resource Group for PMG											
							2011	2012	2013	2014	2015	2016	2017					
							1st Half	2nd Half	1st Half	2nd Half	1st Half	2nd Half	1st Half	2nd Half	1st Half	2nd Half		
							Oct 1	Oct 2	Oct 3	Oct 4	Oct 1	Oct 2	Oct 3	Oct 4	Oct 1	Oct 2	Oct 3	Oct 4
232	190550	Pillar III (T2S specific messages)		207.75d	Thu 01/04/10	Fri 14/01/11												
233	190580	Detailed T2S message specification, development and T2S documentation for UDFS		207.75d	Thu 01/04/10	Fri 14/01/11												
239	192400	Production of first draft T2S customised schema files/documentation by 4CB		79.75d	Tue 28/09/10	Fri 14/01/11												
241	134940	Integration of T2S customised files/docum. By SGMS (incl. Incorporation of UDFS V1.0)		47d	Thu 11/11/10	Fri 14/01/11												
242	190450	Validations of the version v0.3 to produce the UDFS V1.0		517d	Thu 01/10/09	Fri 23/09/11												
243	190460	Validation of v0.3 by PMC & ECB T2S Programme Office		51d	Thu 30/12/10	Wed 09/03/11												
244	190465	UDFS market workshop v0.3		0d	Thu 13/01/11	Thu 13/01/11												
245	190470	ECB T2S programme Office /Market review of UDFS V0.3 (one month)		21d	Thu 30/12/10	Wed 26/01/11												
246	190490	Reception of consolidated ECB/Market feedback on UDFS v0.3 to FC		0d	Wed 26/01/11	Wed 26/01/11												
247	190560	Integration of PMC & ECB T2S Programme Office comments in v0.3 to produce the V1.0 of UDFS (4,5 month)		30d	Thu 27/01/11	Wed 09/03/11												
250	190700	Delivery of UDFS V1.0 to the Market by the ECB		1d	Fri 25/03/11	Fri 25/03/11												
251	190800	Validation of complete UDFS V1.0 by the Market		107d	Thu 10/03/11	Fri 05/08/11												
252	193400	Fifth workshop with the Market on the UDFS		1d	Wed 30/03/11	Wed 30/03/11												
253	193500	Sixth workshop with the Market on the UDFS (Cancelled)		1d	Wed 11/05/11	Wed 11/05/11												
254	195100	Feedback from the Market on the UDFS V1.0		45d	Mon 28/03/11	Fri 27/05/11												
256	196100	Consolidation of Market comments by the ECB		10d	Mon 30/05/11	Fri 10/06/11												
257	198100	Integration of Market comments in complete UDFS V1.0 (two months)		40d	Mon 13/06/11	Fri 05/08/11												
258	199100	Delivery to ECB T2S Programme Office of UDFS V1.1		0d	Fri 05/08/11	Fri 05/08/11												
259	199200	UDFS v1.2 - Messages		486d	Thu 01/10/09	Wed 10/08/11												
260	134500	Pillar II (new standard)		288d	Thu 28/01/10	Fri 04/03/11												
262	134570	Detailed T2S message specification and T2S documentation for UDFS		288d	Thu 28/01/10	Fri 04/03/11												
263	134600	Customisation of draft 150 schema files (incl. definition of fields)/documentation, Validation of draft T2S		288d	Thu 28/01/10	Fri 04/03/11												
265	134670	Validation of draft T2S customised files/documentation by ECB		0d	Fri 04/03/11	Fri 04/03/11												
266	124150	Finalisation of UDFS V1.1 by the SGMS		0d	Fri 04/03/11	Fri 04/03/11												
267	134700	Pillar III (T2S specific messages)		486d	Thu 01/10/09	Wed 10/08/11												
268	134730	Detailed T2S message specification, development and T2S documentation for UDFS		486d	Thu 01/10/09	Wed 10/08/11												
269	134770	Creation of HLRB by 4CB for Validation by SGMS (as BVG)		371d	Thu 01/10/09	Wed 02/03/11												
270	134800	Creation of HLRB for delivery to SGMS (incl. First SWIFT and FC review)		346d	Thu 01/10/09	Wed 26/01/11												
271	134830	SGMS Validate the HLRB (incl. Incorporation of schema files/docum. by SWIFT/RA, iterative process with production of first draft ISO)		330d	Fri 27/11/09	Wed 02/03/11												
272	134870	Production of first draft ISO schema files/docum. by SWIFT/RA, iterative process with production of first draft T2S customised schema files/documentation by 4CB		79d	Tue 01/02/11	Fri 20/05/11												
273	134900	Production of first draft T2S customised schema files/documentation by 4CB		100.75d	Wed 23/03/11	Wed 10/08/11												

Task Critical Milestone Critical Task Milestone Project Summary Group By Summary

T2S Detailed Plan with Critical Path

31/10/2011

ID	ID Number (Number 1)	Task Name	CSD/CB relevant activities	Duration	Start	Finish	Resource Group for PMG											
							2011	2012	2013	2014	2015	2016	2017					
								1st Half	2nd Half	1st Half	2nd Half	1st Half	2nd Half	1st Half	2nd Half	1st Half	2nd Half	
								Oct 1	Oct 2	Oct 3	Oct 4	Oct 1	Oct 2	Oct 3	Oct 4	Oct 1	Oct 2	
275	134950	Validation of draft T2S customised files/docum. By SGMS (incl. Incorporation of the SGMS)	61d	Wed 18/05/11	Wed 10/09/11													
276	134150	Final validation of complete UDFS v1.1 by ECB T2S Programme Office	0d	Fri 01/07/11	Fri 01/07/11													
277	200100	Delivery to ECB T2S PO/Market of updated UDFS chapter 3 (including additional queries and reports)	0d	Mon 08/08/11	Fri 23/09/11													
280	202300	Reception of ECB T2S PO/Market comments on updated UDFS chapter 3	0d	Mon 12/09/11	Fri 23/09/11													
281	202400	(Deliverable) - User Detailed Functional Specification (UDFS) V1.2	0d	Fri 23/09/11	Fri 23/09/11													
288	211100	Start feasibility study	0d	Mon 31/10/11	Mon 31/10/11													
289	211200	Production of UDFS v1.2.1 (CR and Architecture Issues)	0d	Wed 02/11/11	Wed 02/11/11													
290	211300	UDFS v1.2.1 - Messages	290d	Mon 01/08/11	Fri 07/09/12													
291	211400	Pillar III (T2S-specific message)	158d	Mon 01/08/11	Wed 07/03/12													
294	211700	T2S 0285 URD / CR_00096_E (re-modelling of existing PIII messages)	158d	Mon 01/08/11	Wed 07/03/12													
295	211800	Validation of draft T2S customised files/docum. By SGMS (incl. Incorporation of comments by 4CB)	67d	Mon 01/08/11	Tue 01/11/11													
299	212300	T2S 0294 SYS / CR_00086_E (development of 3 new PIII messages)	20d	Wed 05/10/11	Tue 01/11/11													
300	212400	Validation of draft T2S customised files/docum. By SGMS (incl. Incorporation of comments by 4CB)	114d	Mon 05/09/11	Thu 09/02/12													
304	212800	Securities Account Position Response (List of Deviations Item #1)	20d	Fri 13/01/12	Thu 09/02/12													
305	212900	Validation of draft T2S customised files/docum. By SGMS (incl. Incorporation of comments by 4CB)	60d	Thu 15/12/11	Wed 07/03/12													
308	213300	(Deliverable) - User Detailed Functional Specification (UDFS) V1.2.1	13d	Mon 20/02/12	Wed 07/03/12													
322	214800	UDFS v 2.0	0d	Fri 07/09/12	Fri 07/09/12													
323	215100	Validation and revision of UDFS v.2.0 after IAC	86d	Wed 21/08/13	Thu 19/12/13													
326	217100	Internal Eurosystem Preparation [Validation and revision of UDFS v.2.0 after IAC]	64d	Fri 20/09/13	Thu 19/12/13													
327	217200	[Deliverable] - UDFS v.2.0	62d	Fri 20/09/13	Tue 17/12/13													
335	223150	Confirm comprehensiveness to start feasibility assessment	0d	Thu 19/12/13	Thu 19/12/13													
336	536200	Synchronization Point [SP1 - Start Feasibility Confirmed]	0d	Thu 15/12/11	Thu 15/12/11													
337	212100	Graphical User Interface (GUI)	0d	Tue 20/12/11	Tue 20/12/11													
338	260100	Third Workshop GUI Business Functionalities	535d	Fri 12/02/10	Thu 01/03/12													
344	261100	Graphical User Interface (GUI) Business Functionalities	273d	Fri 12/02/10	Mon 28/02/11													
355	274120	Fourth Workshop on T2S GUI	1d	Mon 24/01/11	Mon 24/01/11													
358	281100	Market Feedback on T2S GUI	0d	Mon 28/02/11	Mon 28/02/11													
359	281200	Fifth Workshop on T2S GUI	72d	Wed 02/03/11	Thu 09/06/11													
360	281300	Market Feedback on T2S GUI	1d	Wed 02/03/11	Wed 02/03/11													
361	281400	Market Feedback on T2S GUI	10d	Thu 03/03/11	Wed 16/03/11													
362	281500	Fifth Workshop on T2S GUI	1d	Thu 31/03/11	Thu 31/03/11													

Task Critical Milestone Critical Task Milestone Project Summary Group By Summary

T2S Detailed Plan with Critical Path

31/10/2011

ID	ID Number (Number 1)	Task Name	CSD/CB relevant activities	Duration	Start	Finish	Resource Group for PMG											
							2011	2012	2013	2014	2015	2016	2017					
							1st Half	2nd Half	1st Half	2nd Half	1st Half	2nd Half	1st Half	2nd Half	1st Half	2nd Half		
							Oct 1	Oct 2	Oct 3	Oct 4	Oct 1	Oct 2	Oct 3	Oct 4	Oct 1	Oct 2	Oct 3	Oct 4
363	281600	Market Feedback on T2S GUI	◆	1d	Fri 01/04/11	Thu 14/04/11	14/04/2011											
364	281700	Early market validation of GUI screens	◆	1d	Fri 29/04/11	Fri 29/04/11	29/04/2011											
366	281800	<b>GUI Usability Workshops after SIBOS</b>	◆	76d	Mon 07/11/11	Mon 20/02/12	07/11/2011	07/11/2011	05/01/2012	06/02/2012								
367	281850	Sixth Workshop on T2S GUI	◆	0d	Mon 07/11/11	Mon 07/11/11	07/11/2011											
368	281900	Market Feedbacks on T2S GUI	◆	44d	Mon 07/11/11	Thu 05/01/12	07/11/2011											
369	281950	Seventh Workshop on T2S GUI	◆	0d	Mon 05/02/12	Mon 05/02/12	06/02/2012											
370	282000	Market Feedbacks on T2S GUI	◆	11d	Mon 05/02/12	Mon 20/02/12	06/02/2012											
373	282200	<b>DOCUMENTATION</b>	◆	1045d	Tue 04/05/10	Mon 19/05/14												
374	252100	<b>T2S Smooth Cross CSD settlement</b>	◆	305d	Tue 04/05/10	Fri 01/07/11												
378	253200	<b>1st Mini-consultation</b>	◆	89d	Wed 08/09/10	Fri 07/01/11												
391	257275	<b>2nd Mini-consultation</b>	◆	55d	Tue 30/11/10	Fri 11/02/11												
394	257320	Analysis and preparation of consultation results	◆	35d	Tue 28/12/10	Fri 11/02/11	11/02/2011											
395	257325	3rd Task Force meeting	◆	1d	Fri 21/01/11	Fri 21/01/11	21/01/2011											
396	257330	Publication of mini-consultation results	◆	0d	Fri 11/02/11	Fri 11/02/11	11/02/2011											
398	257400	4rd Task Force meeting	◆	2d	Mon 14/02/11	Tue 15/02/11	15/02/2011											
399	257420	Consultation of NUGS	◆	23d	Tue 01/03/11	Thu 31/03/11	01/03/2011											
400	257440	Report preparation for March 2011 AG	◆	7d	Fri 25/02/11	Mon 07/03/11	07/03/2011											
401	257460	Submission of report to AG	◆	0d	Mon 07/03/11	Mon 07/03/11	07/03/2011											
402	257470	AG Meeting	◆	2d	Tue 08/03/11	Wed 09/03/11	09/03/2011											
403	257480	5rd Task force meeting	◆	1d	Wed 23/03/11	Wed 23/03/11	23/03/2011											
404	257490	6rd Task force meeting	◆	1d	Tue 17/05/11	Tue 17/05/11	17/05/2011											
405	257500	Preparation of final deliverable of smooth cross-CSD settlement in T2S	◆	89d	Mon 28/02/11	Thu 30/06/11	01/06/2011											
406	257520	7th Task Force meeting	◆	1d	Thu 09/06/11	Thu 09/06/11	09/06/2011											
407	257540	Preparation of Report to the June 2011 AG to present the solutions and recommendations on the issues in the list	◆	9d	Fri 10/06/11	Wed 22/06/11	22/06/2011											
408	257560	Submission report to the AG	◆	0d	Wed 22/06/11	Wed 22/06/11	22/06/2011											
409	257570	AG Meeting	◆	2d	Thu 30/06/11	Fri 01/07/11	01/07/2011											
410	258100	Final Delivery of T2S Smooth Cross CSD settlement	◆	0d	Thu 30/06/11	Thu 30/06/11	30/06/2011											
411	259100	[Deliverable] - T2S Smooth Cross CSD settlement Report V1.0	◆	0d	Thu 30/06/11	Thu 30/06/11	30/06/2011											
412	259200	<b>Adaptation to Cross CSD settlement</b>	◆	369d	Fri 01/07/11	Thu 29/11/12												
413	259300	<b>Task Force Activities/Meetings</b>	◆	369d	Fri 01/07/11	Thu 29/11/12												
416	259600	1st Task Force meeting	◆	1d	Wed 07/09/11	Wed 07/09/11	07/09/2011											

Task Critical Milestone Critical Task Milestone Project Summary Group By Summary

T2S Detailed Plan with Critical Path

31/10/2011

ID	ID Number (Number 1)	Task Name	CSD/CB relevant activities	Duration	Start	Finish	Resource Group for PMG	2011		2012		2013		2014		2015		2016		2017	
								1st Half	2nd Half	1st Half	2nd Half	1st Half	2nd Half	1st Half	2nd Half	1st Half	2nd Half	1st Half	2nd Half	1st Half	2nd Half
418	259800	Min-consultation 1	◆	6-4d	Wed 01/02/12	Mon 30/04/12	TF	01/02/2012	30/04/2012												
420	260000	Min-consultation 2	◆	6-4d	Wed 02/05/12	Mon 30/07/12	TF	02/05/2012	30/07/2012												
424	260700	AG Meeting	◆	2d	Mon 26/03/12	Tue 27/03/12	AG	26/03/2012	27/03/2012												
427	261550	AG Meeting November	◆	2d	Wed 28/11/12	Thu 29/11/12	AG	28/11/2012	29/11/2012												
428	261600	<b>Preparation of Adaptation to T2S Cross CSD settlement</b>		313d	Thu 08/09/11	Tue 20/11/12	Eurosystem														
430	261900	Final Delivery of the TF Report to the AG		0d	Tue 20/11/12	Tue 20/11/12	Eurosystem														
431	262000	[Deliverable] - Adaptation to Cross CSD settlement Report	◆	0d	Tue 20/11/12	Tue 20/11/12	Eurosystem														
432	224200	<b>Business Process Description (BPD)</b>		389d	Tue 25/05/10	Fri 18/11/11															
445	225150	<b>BPD V0.1</b>		198d	Fri 30/07/10	Mon 02/05/11															
446	225200	<b>Delivery of the CA BPD Sections</b>		197d	Fri 30/07/10	Fri 29/04/11															
451	226400	Receptions of feedbacks from CASG and update CA BPD Sections	◆	46d	Tue 30/11/10	Mon 31/01/11	Eurosystem														
452	226900	Send CA BPD to the CASG	◆	0d	Mon 21/02/11	Mon 21/02/11	Eurosystem														
453	226950	CASG Meeting	◆	1d	Mon 21/02/11	Mon 21/02/11	Eurosystem														
465	225550	<b>BPD V1.0</b>		122d	Wed 01/06/11	Fri 18/11/11															
466	227300	<b>On going process of reviewing Business Process Description with the Market</b>		101d	Wed 01/06/11	Wed 19/10/11															
467	227400	<b>First Phase: Production of Business Process Description V0.3</b>		56d	Wed 01/06/11	Wed 17/08/11															
468	227500	Delivery of first BPD extract of v0.2 to the Market	◆	0d	Wed 01/06/11	Wed 01/06/11	Eurosystem														
470	227600	First Workshop with the Market on BPD Methodology, Scope and Examples	◆	1d	Wed 15/06/11	Wed 15/06/11	Eurosystem, CSBs, Cbs														
471	227620	Consolidation of comments on BPD from the market	◆	10d	Thu 16/06/11	Wed 29/06/11	Eurosystem														
472	227640	Delivery of BPD v0.3 to the Market	◆	0d	Wed 29/06/11	Wed 29/06/11	Eurosystem														
473	227660	Feedback by market participants on BPD v0.3	◆	15d	Thu 30/06/11	Wed 20/07/11	CSBs, Cbs														
475	228600	<b>Second Phase: Production of Business Process Description V1.0 (including V0.3 &amp; V0.4)</b>		45d	Wed 17/08/11	Wed 19/10/11															
476	228700	Delivery version v.05 to the Market (include BPD v0.4 + BPD v0.3)	◆	0d	Wed 17/08/11	Wed 17/08/11	Eurosystem														
478	228800	Second Workshop with the Market on BPD contents	◆	1d	Thu 08/09/11	Thu 08/09/11	Eurosystem, CSBs, Cbs														
479	228820	Feedback by market participants on BPD v0.5	◆	25d	Thu 18/08/11	Wed 21/09/11	CSBs, Cbs														
486	230000	[Deliverable] - Business Process Description V 1.0 (BPD)	◆	0d	Fri 18/11/11	Fri 18/11/11	Eurosystem														
487	304100	<b>User Handbook (UHB)</b>		661d	Mon 28/02/11	Tue 17/09/13															
488	311100	<b>User Handbook V1.0</b>		475d	Mon 28/02/11	Thu 27/12/12															
505	324100	[Deliverable] - User Hand Book (UHB) V1.0	◆	0d	Thu 27/12/12	Thu 27/12/12	Eurosystem														
506	325100	<b>User Handbook V 2.0</b>		77d	Mon 03/06/13	Tue 17/09/13															
517	335200	[Deliverable] - User Hand Book V2.0 (UHB)	◆	0d	Tue 17/09/13	Tue 17/09/13	Eurosystem														

Legend: Task (blue box), Milestone (black diamond), Critical Milestone (red diamond), Critical Task (red box), Project Summary (grey arrow), Group By Summary (grey arrow)

T2S Detailed Plan with Critical Path  
31/10/2011

ID	ID Number (Number 1)	Task Name	CSD/CB relevant activities	Duration	Start	Finish	Resource Group for PMG	2011				2012				2013				2014				2015				2016				2017									
								1st Half	2nd Half	1st Half	2nd Half	1st Half	2nd Half	1st Half	2nd Half	1st Half	2nd Half	1st Half	2nd Half	1st Half	2nd Half	1st Half	2nd Half	1st Half	2nd Half	1st Half	2nd Half	1st Half	2nd Half	1st Half	2nd Half	1st Half	2nd Half	1st Half	2nd Half						
518	34101	T2S Glossary		353d	Wed 02/07/13	Mon 19/05/14																																			
519	34114	Internal Eurosystem Preparation [T2S Glossary]		347d	Wed 02/04/13	Fri 09/05/14																																			
532	35100	[Deliverable] - T2S Glossary v1.0		0d	Mon 19/05/14	Mon 19/05/14	Eurosystem																																		
533	414300	DEVELOPMENT		1615d	Tue 01/04/08	Mon 23/06/14																																			
534	414400	SOFTWARE AND 4CB TESTING		1232d	Wed 01/04/09	Mon 30/12/13																																			
541	359100	Application Development & Internal Testing		1232d	Wed 01/04/09	Mon 30/12/13																																			
543	351130	Development Process - M2 - UDFS/DBS stabilised and integrated in the development process iterations		0d	Fri 01/04/11	Fri 01/04/11	Eurosystem																																		
544	353130	Development process - M3 - Interfaces specifications frozen (UDFS/GUJ); Iteration 5 technically integrated and tested		0d	Mon 31/10/11	Mon 31/10/11	Eurosystem																																		
545	354130	Development Process - M4 - Start of 4CB JAC		0d	Mon 02/04/12	Mon 02/04/12	Eurosystem																																		
546	355140	Development process - M5 - Technical stability		0d	Fri 28/09/12	Fri 28/09/12	Eurosystem																																		
547	361101	Development process - M6 - Functional stability		0d	Fri 29/03/13	Fri 29/03/13	Eurosystem																																		
548	339200	Development process - M7 - 4CB Internal Acceptance check point - Progress status		0d	Mon 30/09/13	Mon 30/09/13	Eurosystem																																		
559	350100	Iteration 3		197d	Thu 01/07/10	Thu 30/03/11																																			
563	351100	Iteration 4		196d	Fri 01/10/10	Thu 30/06/11																																			
568	352100	Iteration 5		195d	Mon 03/01/11	Fri 30/09/11																																			
573	353100	Iteration 6		261d	Fri 01/04/11	Fri 30/03/12																																			
579	354100	Iteration 7		261d	Fri 01/07/11	Fri 29/06/12																																			
585	355100	Iteration 8		260d	Mon 03/10/11	Fri 28/09/12																																			
591	356100	Iteration 9		257d	Mon 02/04/12	Fri 28/12/12																																			
597	357100	Iteration 10		256d	Mon 02/04/12	Mon 01/04/13																																			
603	365200	Iteration 11		332d	Mon 02/07/12	Wed 16/10/13																																			
617	369700	Iteration 12		318d	Mon 01/10/12	Mon 30/12/13																																			
622	370100	INFRASTRUCTURE		1615d	Tue 01/04/08	Mon 23/06/14																																			
633	377150	4CB - Infrastructure Test		550d	Mon 30/04/12	Mon 23/06/14																																			
634	377155	Preparation Non functional test cases		257d	Mon 30/04/12	Tue 30/04/13																																			
641	377650	Exchanges with the market (non functional test cases)		40d	Mon 23/07/12	Fri 14/09/12	Eurosystem,CSDBs,CS																																		
648	380110	[Deliverable] - T2S Non-functional Testing Scenarios		0d	Wed 02/01/13	Wed 02/01/13	Eurosystem																																		
650	380250	Finish Preparation Infrastructure test		85d	Wed 02/01/13	Tue 30/04/13	Eurosystem																																		
651	380300	Execution Non functional test cases		214d	Tue 30/04/13	Mon 03/03/14																																			
652	378101	Start Execution Infrastructure test		0d	Tue 30/04/13	Tue 30/04/13	Eurosystem																																		
659	386100	[Deliverable] - Non Functional Testing Report		0d	Fri 28/02/14	Fri 28/02/14	Eurosystem																																		

Task      Task      Critical Milestone      Milestone      Critical Task      Project Summary      Group By Summary

T2S Detailed Plan with Critical Path

31/10/2011

ID	ID Number (Number 1)	Task Name	CSD/CB relevant activities	Duration	Start	Finish	Resource Group for PMG											
							2011	2012	2013	2014	2015	2016	2017					
								1st Half	2nd Half	1st Half	2nd Half	1st Half	2nd Half	1st Half	2nd Half	1st Half	2nd Half	
						Qtr. 1	Qtr. 2	Qtr. 3	Qtr. 4	Qtr. 1	Qtr. 2	Qtr. 3	Qtr. 4	Qtr. 1	Qtr. 2	Qtr. 3	Qtr. 4	
664	388100	EUROSYSTEM ACCEPTANCE TEST		1225d	Mon 03/07/11	Fri 02/10/15												
665	389200	EAT PREPARATION		1225d	Mon 03/07/11	Fri 02/10/15												
983	451300	[Deliverable] - CSDs Market specific test cases for EAT V1.0	◆	0d	Thu 17/10/13	Thu 17/10/13												
984	451700	[Deliverable] - CBs Market specific test cases for EAT V1.0	◆	0d	Thu 17/10/13	Thu 17/10/13												
1045	451400	[Deliverable] - EAT Documentation V1.0 (EAT Test Sets)		0d	Thu 14/11/13	Thu 14/11/13												
1071	482300	EAT EXECUTION		265d	Mon 02/12/13	Mon 15/12/14												
1074	485100	Execution Phase EAT Critical		236d	Wed 15/01/14	Fri 12/12/14												
1075	464150	Synchronization Point [SP5: Start of Eurosystem Acceptance Test]		0d	Wed 15/01/14	Wed 15/01/14												
1076	486120	Start EAT - Eurosystem Acceptance Test (following the Entry Criteria)		0d	Wed 15/01/14	Wed 15/01/14												
1089	493130	[Deliverable] EAT Assessment Report	◆	0d	Mon 01/09/14	Mon 01/09/14												
1090	493160	Go-no go decision with CSDs to start the User Testing	◆	0d	Mon 15/09/14	Mon 15/09/14												
1094	498100	EAT Status update (recurrent task during EAT phase until 1 month prior the start of UT)		25d	Wed 12/02/14	Fri 14/03/14												
1099	451800	[Deliverable] - EAT Status update (recurrent task)	◆	0d	Fri 14/03/14	Fri 14/03/14												
1194	524100	CLIENT READINESS		2134d	Mon 17/11/08	Mon 30/01/17												
1195	524200	SYNCHRONISATION AND ON-BOARDING		2134d	Mon 17/11/08	Mon 30/01/17												
1196	534200	CSD READINESS		1950d	Fri 31/07/09	Mon 30/01/17												
1275	536000	CSDs Feasibility Assessment		280d	Mon 21/11/11	Mon 17/12/12												
1276	536100	Preparation of impact assessment and adaptation plan by CSDs	◆	160d	Mon 21/11/11	Fri 29/06/12												
1277	213100	[Deliverable] - CSD Feasibility Assessment	◆	0d	Fri 29/06/12	Fri 29/06/12												
1280	538200	Assessment of feasibility confirmation	◆	0d	Fri 10/08/12	Fri 10/08/12												
1281	214100	Synchronization Point [SP 2 - Feasibility Confirmation by CSD/CE]	◆	0d	Fri 10/08/12	Fri 10/08/12												
1283	540800	Confirmation of T2S programme plan status and achieved milestones	◆	0d	Mon 17/12/12	Mon 17/12/12												
1284	553000	Update on CSD Feasibility Assessment	◆	0d	Mon 17/12/12	Mon 17/12/12												
1285	553100	Synchronisation Point [SP 3 - T2S Programme Plan Comprehensiveness]	◆	0d	Mon 17/12/12	Mon 17/12/12												
1546	625200	Proof of Eligibility to Participate in T2S (Wave 1)		67d	Mon 10/11/14	Mon 16/02/15												
1551	625460	Send Check List of Implementation Guide for Eligibility Criteria to the CSDs	◆	0d	Tue 16/12/14	Tue 16/12/14												
1552	625500	Delivery the Proof of Eligibility to Participate in T2S by CSDs to CEs. CEs submit their application to access T2S services with a signed [Deliverable] - Proof of Eligibility to Participate in T2S (Wave 1)	◆	0d	Mon 19/01/15	Mon 19/01/15												
1553	625600	[Deliverable] - Proof of Eligibility to Participate in T2S (Wave 1)	◆	0d	Mon 19/01/15	Mon 19/01/15												
1555	625800	PB provides confirmation to the CSDs	◆	0d	Mon 16/02/15	Mon 16/02/15												
1556	625900	Proof of Eligibility to Participate in T2S (Wave 2)		67d	Mon 13/07/15	Tue 13/10/15												
1561	626500	Send Check List of Implementation Guide for Eligibility Criteria to the CSDs	◆	0d	Tue 18/08/15	Tue 18/08/15												

T2S Detailed Plan with Critical Path

31/10/2011

ID	ID Number (Number 1)	Task Name	CSD/CB relevant activities	Duration	Start	Finish	Resource Group for PMG	2011		2012		2013		2014		2015		2016		2017			
								1st Half	2nd Half	1st Half	2nd Half	1st Half	2nd Half	1st Half	2nd Half	1st Half	2nd Half	1st Half	2nd Half	1st Half	2nd Half	1st Half	2nd Half
								Qtr.1	Qtr.2	Qtr.3	Qtr.4	Qtr.1	Qtr.2	Qtr.3	Qtr.4	Qtr.1	Qtr.2	Qtr.3	Qtr.4	Qtr.1	Qtr.2	Qtr.3	Qtr.4
1562	626600	Delivery of Proof of Eligibility to Participate in T2S by CSDs to ECB. CSDs submit their application to access T2S services with a self-assessment report.	0d	Tue 15/09/15	Tue 15/09/15		CSDs																
1563	626700	[Deliverable] - Proof of Eligibility to Participate in T2S (Wave 2)	0d	Tue 15/09/15	Tue 15/09/15		CSDs																
1565	626900	PB provides confirmation to the CSDs	0d	Tue 13/10/15	Tue 13/10/15		T2SPB																
1566	627000	<b>Proof of Eligibility to Participate in T2S (Wave 3)</b>	67d	Fri 01/01/16	Tue 29/03/16		Eurosystem																
1571	627800	Send Check List of Implementation Guide for Eligibility Criteria to the CSDs	0d	Thu 04/02/16	Thu 04/02/16		Eurosystem																
1572	627900	Delivery of the Proof of Eligibility to Participate in T2S by CSDs to ECB. CSDs submit their application to access T2S services with a self-assessment report.	0d	Thu 03/03/16	Thu 03/03/16		CSDs																
1573	628000	[Deliverable] - Proof of Eligibility to Participate in T2S (Wave 3)	0d	Thu 03/03/16	Thu 03/03/16		CSDs																
1575	628400	PB provides confirmation to the CSDs	0d	Tue 29/03/16	Tue 29/03/16		T2SPB																
1576	544100	<b>CB READINESS</b>	882d	Fri 31/07/09	Mon 17/12/12																		
1581	536300	<b>CBs Feasibility Assessment</b>	280d	Mon 21/11/11	Mon 17/12/12																		
1582	536310	Preparation of impact assessment and adaptation plan by CBs	160d	Mon 21/11/11	Fri 29/06/12		CBs																
1583	546500	[Deliverable] - CB Feasibility Assessment	0d	Fri 29/06/12	Fri 29/06/12		CBs																
1586	546595	Assessment of feasibility confirmation	0d	Fri 10/08/12	Fri 10/08/12		Eurosystem																
1587	546600	<b>Synchronization Point (SP2 - Feasibility Confirmation by CSD/ CB)</b>	0d	Fri 10/08/12	Fri 10/08/12		Eurosystem																
1589	546900	Confirmation of T2S programme plan status and achieved milestones	0d	Mon 17/12/12	Mon 17/12/12		Eurosystem																
1590	553200	Update on CB Feasibility Assessment	0d	Mon 17/12/12	Mon 17/12/12		CBs																
1591	546800	<b>Synchronisation Point (SP3 - T2S Programme Plan Comprehensiveness)</b>	0d	Mon 17/12/12	Mon 17/12/12		Eurosystem, CB																
1633	516600	<b>USER TRAINING AND TESTING</b>	1953d	Fri 02/01/09	Wed 13/07/16																		
1634	555100	<b>TRAINING PREPARATION</b>	1119d	Mon 02/08/10	Mon 01/12/14																		
1635	556100	<b>Preparation of the T2S Training Framework</b>	480d	Mon 02/08/10	Thu 31/05/12																		
1645	558100	<b>Training Framework Phase</b>	436d	Thu 30/09/10	Thu 31/05/12																		
1654	559700	<b>Consultation of Public Training Framework V0.1 with CSDs and CBs</b>	35d	Mon 16/04/12	Fri 02/03/12																		
1655	559800	Delivery of Public Training Framework V0.1 to the CSDs and CBs for advice	0d	Mon 16/04/12	Mon 16/04/12		Eurosystem																
1656	559900	Feedback from CSDs and CBs on Public Training Framework V0.1	20d	Mon 16/04/12	Fri 10/02/12		CSDs, CBs																
1658	556500	Workshop with CSDs and CBs on Public Training Framework V0.1 (in case of need)	1d	Fri 02/03/12	Fri 02/03/12		ECB, ECB, CSDs, CBs																
1659	556600	Integration of CSDs and CBs feedback in Public Training Framework V0.2	15d	Mon 05/03/12	Fri 23/03/12		Eurosystem																
1668	562100	[Deliverable] - T2S Public Training Framework V1.0	0d	Thu 31/05/12	Thu 31/05/12		Eurosystem																
1678	563100	<b>Training Materials preparation</b>	603d	Mon 23/07/12	Mon 01/12/14																		
1685	566400	Publication of T2S Training Calendar	0d	Mon 17/12/12	Mon 17/12/12		Eurosystem																
1686	566500	<b>Internal Eurosystem Preparation [Training Materials]</b>	540d	Fri 26/09/12	Mon 10/11/14																		
1700	568100	[Deliverable] - Basic Training Materials	0d	Mon 03/06/13	Mon 03/06/13		Eurosystem																

Legend: Task (blue box), Critical Milestone (red diamond), Critical Task (red box), Milestone (black diamond), Project Summary (grey arrow), Group By Summary (grey arrow)



T2S Detailed Plan with Critical Path

31/10/2011

9 of 27

ID	ID Number (Number 1)	Task Name	CSD/CB relevant activities	Duration	Start	Finish	Resource Group for PMG	2011		2012		2013		2014		2015		2016		2017	
								1st Half	2nd Half	1st Half	2nd Half	1st Half	2nd Half	1st Half	2nd Half	1st Half	2nd Half	1st Half	2nd Half	1st Half	2nd Half
								Qtr 1	Qtr 2	Qtr 3	Qtr 4	Qtr 1	Qtr 2	Qtr 3	Qtr 4	Qtr 1	Qtr 2	Qtr 3	Qtr 4	Qtr 1	Qtr 2
1702	568400	[Deliverable] - Technical Training Materials	◆	0d	Tue 03/09/13	Tue 03/09/13	Eurosystem														
1704	568600	[Deliverable] - Functional Training Materials	◆	0d	Tue 03/12/13	Tue 03/12/13	Eurosystem														
1706	568800	[Deliverable] - Operational Training Materials	◆	0d	Fri 20/06/14	Fri 20/06/14	Eurosystem														
1708	569000	[Deliverable] - Testing Training Materials	◆	0d	Tue 03/06/14	Tue 03/06/14	Eurosystem														
1710	569200	[Deliverable] - Migration Training Materials	◆	0d	Mon 01/12/14	Mon 01/12/14	Eurosystem														
1711	574200	<b>TRAINING EXECUTION</b>		786d	Mon 01/07/13	Wed 13/07/16															
1712	575100	<b>Training Session</b>		471d	Mon 01/07/13	Wed 06/05/15															
1713	575101	Start training session	◆	0d	Mon 01/07/13	Mon 01/07/13	Eurosystem, CSDs, CBs														
1714	575900	First series of basic training sessions	◆	66d	Mon 01/07/13	Mon 30/09/13	Eurosystem, CSDs, CBs														
1715	576100	Training sessions for technical advanced training	◆	62d	Tue 01/10/13	Mon 30/12/13	Eurosystem, CSDs, CBs														
1716	578100	Training sessions for functional advanced training	◆	61d	Mon 06/01/14	Mon 31/03/14	Eurosystem, CSDs, CBs														
1717	577100	Training session for operational advanced training	◆	66d	Tue 01/07/14	Tue 30/09/14	Eurosystem, CSDs, CBs														
1718	580100	Training sessions on testing	◆	66d	Tue 01/07/14	Tue 30/09/14	Eurosystem, CSDs, CBs														
1719	580200	Second series of basic training sessions	◆	63d	Wed 01/10/14	Fri 02/01/15	Eurosystem, CSDs, CBs														
1720	579100	First series of Migration training sessions	◆	88d	Fri 02/01/15	Wed 06/05/15	Eurosystem, CSDs, CBs														
1721	580150	CSDs and CBs training sessions finalised before wave 1	◆	0d	Wed 06/05/15	Wed 06/05/15	Eurosystem, CSDs, CBs														
1722	581100	<b>Refresh-training before go-live</b>		300d	Thu 28/05/15	Wed 13/07/16															
1726	583100	<b>USER TESTING PREPARATION</b>		1463d	Fri 02/01/09	Wed 27/08/14															
1734	592200	<b>T2S User Testing Calendar</b>		224d	Mon 29/04/13	Thu 13/03/14															
1735	592300	<b>Internal Eurosystem Preparation [T2S User Testing Calendar]</b>		90d	Mon 29/04/13	Fri 30/08/13															
1739	593400	<b>Market consultation on T2S User Testing calendar</b>	◆	134d	Mon 02/09/13	Thu 13/03/14															
1756	597300	[Deliverable] - User Testing Calendar	◆	0d	Thu 13/03/14	Thu 13/03/14	Eurosystem														
1757	616200	<b>Certification Test Sets</b>		334d	Fri 01/03/13	Thu 19/06/14															
1758	616300	<b>Internal Eurosystem Preparation [Certification Test Sets]</b>		334d	Fri 01/03/13	Thu 19/06/14															
1762	616540	<b>Market Consultation/Information on Certification test sets</b>	◆	164d	Mon 28/10/13	Thu 19/06/14															
1780	634600	[Deliverable] - CSD Certification Test Cases	◆	0d	Thu 19/06/14	Thu 19/06/14	Eurosystem														
1781	634700	[Deliverable] - CB Certification Test Cases	◆	0d	Thu 19/06/14	Thu 19/06/14	Eurosystem														
1782	634800	[Deliverable] - DCP Certification Test Cases	◆	0d	Thu 19/06/14	Thu 19/06/14	Eurosystem														
1807	603100	<b>UT Registration Guide</b>		284d	Mon 04/03/13	Fri 11/04/14															
1808	603200	<b>Internal Eurosystem Preparation [UT Registration Guide]</b>		100d	Mon 04/03/13	Fri 19/07/13															
1812	606140	<b>Market information on UT Registration Guide</b>	◆	128d	Mon 22/07/13	Wed 22/01/14															

Task [ ] Milestone [◆] Critical Milestone [◆] Critical Task [ ] Project Summary [ ] Group By Summary [ ]

T2S Detailed Plan with Critical Path

ID	ID Number (Number-1)	Task Name	CSD/CB relevant activities	Duration	Start	Finish	Resource Group for PMG	2011		2012		2013		2014		2015		2016		2017	
								1st Half	2nd Half	1st Half	2nd Half	1st Half	2nd Half	1st Half	2nd Half	1st Half	2nd Half	1st Half	2nd Half	1st Half	2nd Half
1827	607200	[Deliverable] - Registration Guide for User Testing	◆	0d	Wed 22/01/14	Wed 22/01/14	Eurosystem														
1828	627100	Completed UT Registration Guide for User Testing (network registration)	◆	0d	Fri 11/04/14	Fri 11/04/14	CSDs,CBs								◆ 11/04/2014						
1829	611100	User Testing Guide		283d	Mon 04/02/13	Wed 12/03/14															
1830	611200	Internal Eurosystem Preparation [User Testing Guide]		150d	Mon 04/02/13	Fri 30/08/13															
1834	612240	Market consultation on User Testing Guide	◆	133d	Mon 02/09/13	Wed 12/03/14															
1849	616100	[Deliverable] - User Testing Guide	◆	0d	Wed 12/03/14	Wed 12/03/14	Eurosystem								◆ 12/03/2014						
1857	626100	[Predecessors] UT Environment Preparation		114d	Mon 30/12/13	Wed 11/06/14															
1858	629100	Completed network connectivity set-up by CSDs,CBs with the Network Service Provider	◆	0d	Fri 11/04/14	Fri 11/04/14	CSDs,CBs								◆ 11/04/2014						
1859	626150	Delivery of Connectivity Set-up report by CSDs/CBs	◆	0d	Thu 24/04/14	Thu 24/04/14	CSDs,CBs								◆ 24/04/2014						
1860	628150	Send UT Registration Guide to the CSDs/CBs	◆	0d	Wed 14/05/14	Wed 14/05/14	Eurosystem								◆ 14/05/2014						
1861	628200	UT Registration Guide filled in by CSDs/CBs	◆	0d	Tue 10/06/14	Tue 10/06/14	CSDs,CBs								◆ 10/06/2014						
1864	629200	Readiness of interconnected system (T2,CBR2)	◆	0d	Mon 30/12/13	Mon 30/12/13	Eurosystem								◆ 30/12/2013						
1865	630100	UT Environment Preparation		20d	Wed 11/06/14	Tue 08/07/14															
1869	634200	UT environment ready	◆	0d	Wed 11/06/14	Wed 11/06/14	Eurosystem								◆ 11/06/2014						
1870	634300	Delivery updated version of the EAT Status update	◆	0d	Wed 27/08/14	Wed 27/08/14	Eurosystem								◆ 27/08/2014						
1871	497100	Synchronization Point [SP6 - Eurosystem Ready for User Testing]	◆	0d	Tue 02/09/14	Tue 02/09/14	Eurosystem								◆ 02/09/2014						
1872	635900	Predecessor of Connectivity before Interoperability Testing		126d	Mon 30/12/13	Mon 30/06/14															
1873	641100	Delivery HOP	◆	0d	Thu 24/04/14	Thu 24/04/14	Eurosystem								◆ 24/04/2014						
1874	641130	Internal system adapted according to UDFS specifications by CBs	◆	0d	Mon 30/06/14	Mon 30/06/14	CBs								◆ 30/06/2014						
1875	641150	Internal system adapted according to UDFS specifications by CSDs/CBs	◆	0d	Mon 30/06/14	Mon 30/06/14	CSDs,CBs								◆ 30/06/2014						
1876	643100	Completed Registration to the (testing) network (Users, ECB)	◆	0d	Tue 24/06/14	Tue 24/06/14	Eurosystem,CSDs								◆ 24/06/2014						
1877	644100	Completed training sessions on Connectivity	◆	0d	Mon 30/12/13	Mon 30/12/13	Eurosystem,CSDs								◆ 30/12/2013						
1878	644200	Interim verification of the List of Potential Show stopper from CSDs (dependencies with local regulation)	◆	0d	Mon 09/06/14	Mon 09/06/14	CSDs,CBs								◆ 09/06/2014						
1879	636100	USER TESTING EXECUTION		517d	Mon 07/07/14	Wed 29/06/16															
1880	645100	Synchronization Point [SP7 - Start Connectivity Testing]	◆	0d	Mon 07/07/14	Mon 07/07/14	Eurosystem,CSDs,CBs								◆ 07/07/2014						
1881	645150	Connectivity Testing for Interoperability wave 1		82d	Mon 07/07/14	Wed 29/10/14															
1886	646160	[Deliverable] - User Testing Stage Report (Wave 1) V1.0 [Connectivity phases]	◆	0d	Tue 30/09/14	Tue 30/09/14	Eurosystem														
1890	649200	Synchronization Point [SP8 - Start Bilateral Interoperability Testing]	◆	0d	Wed 01/10/14	Wed 01/10/14	Eurosystem,CSDs,CBs								◆ 01/10/2014						
1891	649250	Acceptance Phase		126d	Thu 02/10/14	Thu 02/04/15															
1892	647200	CSD Acceptance phase wave 1	◆	60d	Thu 02/10/14	Mon 29/12/14															
1893	647300	CSD Acceptance wave 1	◆	60d	Thu 02/10/14	Mon 29/12/14	CSDs,CBs														

Legend: Task (blue box), Milestone (black diamond), Critical Milestone (red diamond), Critical Task (red box), Project Summary (grey arrow), Group By Summary (grey arrow)

T2S Detailed Plan with Critical Path

31/10/2011

11 of 27

ID	ID Number (Number 1)	Task Name	CSD/CB relevant activities	Duration	Start	Finish	Resource Group for PMG											
							2011	2012	2013	2014	2015	2016	2017					
					1st Half	2nd Half	1st Half	2nd Half	1st Half	2nd Half	1st Half	2nd Half	1st Half	2nd Half	1st Half	2nd Half		
					Qtr. 1	Qtr. 2	Qtr. 3	Qtr. 4	Qtr. 1	Qtr. 2	Qtr. 3	Qtr. 4	Qtr. 1	Qtr. 2	Qtr. 3	Qtr. 4		
1894	647360	[Deliverable] - CSD's T2S Compliance Confirmation (Wave 1)	◆	0d	Mon 29/12/14	Mon 29/12/14												
1895	647330	[Deliverable] - CSD's T2S Non-Compliance Notification (Wave 1)	◆	0d	Mon 29/12/14	Mon 29/12/14												
1896	649000	<b>CB Acceptance phase wave 1</b>	◆	60d	<b>Thu 02/10/14</b>	<b>Mon 29/12/14</b>												
1897	649020	CB Acceptance wave 1	◆	60d	Thu 02/10/14	Mon 29/12/14												
1898	649040	[Deliverable] - CB's T2S Compliance Confirmation (Wave 1)	◆	0d	Mon 29/12/14	Mon 29/12/14												
1899	649060	[Deliverable] - CB's T2S Non-Compliance Notification (Wave 1)	◆	0d	Mon 29/12/14	Mon 29/12/14												
1900	647350	<b>CSD Acceptance phase wave 2</b>	◆	126d	<b>Thu 02/10/14</b>	<b>Thu 02/04/15</b>												
1901	647400	CSD Acceptance wave 2	◆	126d	Thu 02/10/14	Thu 02/04/15												
1902	647460	[Deliverable] - CSD's T2S Compliance Confirmation (Wave 2)	◆	0d	Thu 02/04/15	Thu 02/04/15												
1903	647430	[Deliverable] - CSD's T2S Non-Compliance Notification (Wave 2)	◆	0d	Thu 02/04/15	Thu 02/04/15												
1904	649300	<b>CB Acceptance phase wave 2</b>	◆	126d	<b>Thu 02/10/14</b>	<b>Thu 02/04/15</b>												
1905	649400	CB Acceptance wave 2	◆	126d	Thu 02/10/14	Thu 02/04/15												
1906	649500	[Deliverable] - CB's T2S Compliance Confirmation (Wave 2)	◆	0d	Thu 02/04/15	Thu 02/04/15												
1907	649600	[Deliverable] - CB's T2S Non-Compliance Notification (Wave 2)	◆	0d	Thu 02/04/15	Thu 02/04/15												
1908	647450	<b>CSD Acceptance phase wave 3</b>	◆	126d	<b>Thu 02/10/14</b>	<b>Thu 02/04/15</b>												
1909	647500	CSD Acceptance wave 3	◆	126d	Thu 02/10/14	Thu 02/04/15												
1910	647560	[Deliverable] - CSD's T2S Compliance Confirmation (Wave 3)	◆	0d	Thu 02/04/15	Thu 02/04/15												
1911	647530	[Deliverable] - CSD's T2S Non-Compliance Notification (Wave 3)	◆	0d	Thu 02/04/15	Thu 02/04/15												
1912	649700	<b>CB Acceptance phase wave 3</b>	◆	126d	<b>Thu 02/10/14</b>	<b>Thu 02/04/15</b>												
1913	649800	CB Acceptance wave 3	◆	126d	Thu 02/10/14	Thu 02/04/15												
1914	649850	[Deliverable] - CB's T2S Compliance Confirmation (Wave 3)	◆	0d	Thu 02/04/15	Thu 02/04/15												
1915	649900	[Deliverable] - CB's T2S Non-Compliance Notification (Wave 3)	◆	0d	Thu 02/04/15	Thu 02/04/15												
1916	647550	<b>Certification Phase</b>	◆	184d	<b>Thu 02/10/14</b>	<b>Mon 22/06/15</b>												
1917	647600	<b>CSD Certification phase wave 1</b>	◆	60d	<b>Thu 02/10/14</b>	<b>Mon 29/12/14</b>												
1918	647700	CSD Certification wave 1	◆	55d	Thu 02/10/14	Thu 18/12/14												
1920	647950	[Deliverable] - Eurosystem T2S Certification (Wave 1)	◆	0d	Mon 29/12/14	Mon 29/12/14												
1921	647890	<b>CB Certification phase wave 1</b>	◆	60d	<b>Thu 02/10/14</b>	<b>Mon 29/12/14</b>												
1922	647900	CB Certification wave 1	◆	55d	Thu 02/10/14	Thu 18/12/14												
1924	647960	[Deliverable] - Eurosystem T2S Certification (Wave 1)	◆	0d	Mon 29/12/14	Mon 29/12/14												
1925	647990	<b>CSD Certification phase wave 2</b>	◆	125d	<b>Thu 02/10/14</b>	<b>Wed 01/04/15</b>												
1926	648000	CSD Certification wave 2	◆	120d	Thu 02/10/14	Wed 25/03/15												

Task  Milestone  Critical Milestone  Critical Task  Project Summary  Group By Summary

T2S Detailed Plan with Critical Path

31/10/2011

12 of 27

ID	ID Number (Number 1)	Task Name	CSD/CB relevant activities	Duration	Start	Finish	Resource Group for PMG	2011		2012		2013		2014		2015		2016		2017	
								1st Half	2nd Half	1st Half	2nd Half	1st Half	2nd Half	1st Half	2nd Half	1st Half	2nd Half	1st Half	2nd Half	1st Half	2nd Half
1928	648290	[Deliverable] - Eurosystem T2S Certification (Wave 2)	0d	Wed 01/04/15	Wed 01/04/15	Wed 01/04/15	Eurosystem														
1929	648290	<b>CB Certification phase wave 2</b>	125d	Thu 02/10/14	Wed 01/04/15	Wed 01/04/15	Eurosystem														
1930	648300	CB Certification wave 2	120d	Thu 02/10/14	Wed 25/03/15	Wed 25/03/15	CSBs, CBs														
1932	648360	[Deliverable] - Eurosystem T2S Certification (Wave 2)	0d	Wed 01/04/15	Wed 01/04/15	Wed 01/04/15	Eurosystem														
1933	648390	<b>CSD Certification phase wave 3</b>	184d	Thu 02/10/14	Mon 22/06/15	Mon 22/06/15	Eurosystem														
1934	648400	CSD Certification wave 3	179d	Thu 02/10/14	Wed 17/06/15	Wed 17/06/15	CSBs, CBs														
1936	648550	[Deliverable] - Eurosystem T2S Certification (Wave 3)	0d	Mon 22/06/15	Mon 22/06/15	Mon 22/06/15	Eurosystem														
1937	648590	<b>CB Certification phase wave 3</b>	184d	Thu 02/10/14	Mon 22/06/15	Mon 22/06/15	Eurosystem														
1938	648600	CB Certification wave 3	179d	Thu 02/10/14	Wed 17/06/15	Wed 17/06/15	CSBs, CBs														
1940	648550	[Deliverable] - Eurosystem T2S Certification (Wave 3)	0d	Mon 22/06/15	Mon 22/06/15	Mon 22/06/15	Eurosystem														
1941	650100	<b>Interoperability - Community - Business Day Testing Wave 1</b>	447d	Mon 01/09/14	Wed 18/05/16	Wed 18/05/16	Eurosystem														
1942	652100	<b>Interoperability Bilateral Testing Wave 1</b>	55d	Wed 01/10/14	Thu 18/12/14	Thu 18/12/14	Eurosystem, CSBs														
1944	653110	Start Interoperability Bilateral Testing Wave 1	0d	Wed 01/10/14	Wed 01/10/14	Wed 01/10/14	Eurosystem, CSBs														
1999	714200	Finish Interoperability Bilateral Testing Wave 1	0d	Thu 18/12/14	Thu 18/12/14	Thu 18/12/14	Eurosystem														
2001	714280	[Deliverable] - User Testing Stage Report (Wave 1) V1.1 [Interoperability Bilateral phase]	0d	Thu 18/12/14	Thu 18/12/14	Thu 18/12/14	Eurosystem														
2002	714300	<b>Synchronization Point [SP9.1 - Start Multilateral Interoperability Testing (wave 1)]</b>	0d	Mon 29/12/14	Mon 29/12/14	Mon 29/12/14	Eurosystem, CSBs, CBs														
2003	722000	<b>Interoperability Multilateral testing Wave 1</b>	45d	Tue 30/12/14	Wed 04/03/15	Wed 04/03/15	Eurosystem														
2007	723100	[Deliverable] - User Testing Stage Report (Wave 1) V1.2 [Interoperability Multilateral phase]	0d	Wed 04/03/15	Wed 04/03/15	Wed 04/03/15	Eurosystem														
2040	726400	<b>Connectivity Testing for Migration wave 1</b>	42d	Mon 01/09/14	Wed 29/10/14	Wed 29/10/14	Eurosystem														
2044	726800	<b>Migration Wave 1</b>	100d	Wed 03/09/14	Tue 27/01/15	Tue 27/01/15	Eurosystem														
2053	730100	<b>Synchronization Point [SP10.1 - Start Community Testing Wave 1]</b>	0d	Wed 04/03/15	Wed 04/03/15	Wed 04/03/15	Eurosystem, CSBs, CBs														
2054	730200	<b>Connectivity Testing for Community wave 1</b>	20d	Thu 05/02/15	Wed 04/03/15	Wed 04/03/15	Eurosystem														
2057	731100	<b>Community testing Wave 1</b>	50d	Wed 04/03/15	Thu 14/05/15	Thu 14/05/15	Eurosystem														
2058	732100	<b>Community Testing Wave 1 - [First Window]</b>	25d	Wed 04/03/15	Wed 08/04/15	Wed 08/04/15	Eurosystem														
2059	732101	Start Community Test Wave 1	0d	Wed 04/03/15	Wed 04/03/15	Wed 04/03/15	Eurosystem, CSBs, CBs														
2090	762100	<b>Community Testing Wave 1 - [Second Window]</b>	20d	Thu 09/04/15	Thu 07/05/15	Thu 07/05/15	Eurosystem														
2118	769200	Finish Community Test Wave 1	0d	Thu 07/05/15	Thu 07/05/15	Thu 07/05/15	Eurosystem, CSBs														
2120	789400	[Deliverable] - User Testing Stage Report (Wave 1) V1.3 [Community phase]	0d	Thu 14/05/15	Thu 14/05/15	Thu 14/05/15	Eurosystem														
2121	789500	<b>DCP-DCAH Certification phase wave 1</b>	30d	Thu 05/03/15	Wed 15/04/15	Wed 15/04/15	Eurosystem														
2124	789800	[Deliverable] - Certification report for DCPs (Wave 1)	0d	Wed 15/04/15	Wed 15/04/15	Wed 15/04/15	Eurosystem														
2127	792000	[Deliverable] - Certification report for DCAH (Wave 1)	0d	Wed 15/04/15	Wed 15/04/15	Wed 15/04/15	Eurosystem														

Legend: Task (blue box), Milestone (black diamond), Critical Milestone (red diamond), Critical Task (red box), Project Summary (grey arrow), Group By Summary (grey arrow)



T2S Detailed Plan with Critical Path

31/10/2011

ID	ID Number (Number 1)	Task Name	CSD/CB relevant activities	Duration	Start	Finish	Resource Group for PMG											
							2011		2012		2013		2014		2015		2016	
								1st Half	2nd Half	1st Half	2nd Half	1st Half	2nd Half	1st Half	2nd Half	1st Half	2nd Half	
						Qtr. 1	Qtr. 2	Qtr. 1	Qtr. 2	Qtr. 1	Qtr. 2	Qtr. 1	Qtr. 2	Qtr. 1	Qtr. 2	Qtr. 1	Qtr. 2	
2345	954000	Finish Community Test Wave 2	◆	0d	Wed 28/10/15	Wed 28/10/15												
2347	979300	[Deliverable] - User Testing Stage Report (Wave 2) V2.3 [Community phase]	◆	0d	Wed 04/11/15	Wed 04/11/15												
2348	979400	DCP-DCAH Certification phase wave 2	◆	65d	Thu 09/07/15	Wed 07/10/15												
2351	979700	[Deliverable] - Certification report for DCPs (Wave 2)	◆	0d	Wed 07/10/15	Wed 07/10/15												
2354	981000	[Deliverable] - Certification report for DCAH (Wave 2)	◆	0d	Wed 07/10/15	Wed 07/10/15												
2355	1024400	Synchronization Point [SP.11.2 - Start Business Day Testing Wave 2]	◆	0d	Mon 09/11/15	Mon 09/11/15												
2356	986100	Business day test Wave 2	◆	44d	Mon 09/11/15	Mon 11/01/16												
2357	986200	Start Business day test Wave 2	◆	0d	Mon 09/11/15	Mon 09/11/15												
2378	1021200	Finish Business day test Wave 2	◆	0d	Mon 28/12/15	Mon 28/12/15												
2380	1023300	[Deliverable] - User Testing Stage Report (Wave 2) V2.4 [Business day phase]	◆	0d	Mon 11/01/16	Mon 11/01/16												
2381	1022500	Progress Report Wave 2 (recurrent task during UT phase End of User Testing Wave 2)	◆	10d	Fri 28/11/14	Thu 11/12/14												
2382	1022600	Preparation Progress Report Wave 2 (recurrent task)	◆	10d	Fri 28/11/14	Thu 11/12/14												
2383	1022700	[Deliverable] - Progress Report Wave 2 (recurrent task)	◆	0d	Thu 11/12/14	Thu 11/12/14												
2384	1022800	Support Testing for other waves	◆	319d	Thu 05/03/15	Wed 18/05/16												
2385	1022900	Support Community Test of wave 1	◆	75d	Thu 05/03/15	Thu 18/06/15												
2386	1023000	Support Community Test of wave 3	◆	140d	Tue 10/11/15	Wed 18/05/16												
2387	1023100	Synchronization Point [SP.12.2 - End of User Testing Execution Phase Wave 2]	◆	0d	Mon 18/01/16	Mon 18/01/16												
2388	2200000	Interoperability - Community - Business Day Testing Wave 3	◆	517d	Mon 07/07/14	Wed 29/06/16												
2389	2200100	Connectivity Testing for Interoperability wave 3	◆	82d	Mon 07/07/14	Wed 29/10/14												
2394	2200600	[Deliverable] - User Testing Stage Report (Wave 3) V3.0 [Connectivity phase]	◆	0d	Tue 30/09/14	Tue 30/09/14												
2395	2201000	Interoperability Bilateral testing Wave 3	◆	185d	Wed 01/10/14	Tue 23/06/15												
2396	2202000	Interoperability Bilateral Testing Wave 3 [First Window]	◆	80d	Wed 01/10/14	Wed 28/01/15												
2397	2203000	Start Interoperability Bilateral Test Wave 3	◆	0d	Wed 01/10/14	Wed 01/10/14												
2455	2273000	Finish Interoperability Bilateral Testing Wave 3 Second window	◆	0d	Tue 23/06/15	Tue 23/06/15												
2457	2273080	[Deliverable] - User Testing Stage Report (Wave 3) V3.1 [Interoperability Bilateral phase]	◆	0d	Tue 23/06/15	Tue 23/06/15												
2458	2273500	Synchronization Point [SP.9.3 - Start Multilateral Interoperability Testing (Wave 3)]	◆	0d	Tue 23/06/15	Tue 23/06/15												
2459	2273100	Interoperability Multilateral testing Wave 3	◆	93d	Wed 24/06/15	Fri 30/10/15												
2463	2275000	[Deliverable] - User Testing Stage Report(Wave 3) V3.2 [Interoperability Multilateral phase]	◆	0d	Fri 30/10/15	Fri 30/10/15												
2496	2282050	Connectivity Testing for Migration wave 3	◆	40d	Fri 10/04/15	Fri 05/06/15												
2500	2282400	Migration Wave 3	◆	148d	Fri 17/04/15	Mon 09/11/15												
2504	2276000	[Predecessors] Community test	◆	138d	Thu 02/04/15	Mon 12/10/15												

Task Critical Milestone Critical Task Milestone Project Summary Group By Summary

T2S Detailed Plan with Critical Path

31/10/2011

ID	ID Number (Number 1)	Task Name	CSD/CB relevant activities	Duration	Start	Finish	Resource Group for PMG	2011		2012		2013		2014		2015		2016		2017	
								1st Half	2nd Half	1st Half	2nd Half	1st Half	2nd Half	1st Half	2nd Half	1st Half	2nd Half	1st Half	2nd Half	1st Half	2nd Half
2505	2276100	Delivery certification Step1 (CSDs able to use T2S functionalities)	◆	0d	Mon 22/06/15	Mon 22/06/15	CSDs														
2507	2281000	Confirmation that CSDs participants are ready (wave 3)	◆	0d	Mon 12/10/15	Mon 12/10/15	CSDs									◆	12/10/2015				
2508	2282000	Confirmation that CB members are ready (wave 3)	◆	0d	Mon 12/10/15	Mon 12/10/15	CBs														
2510	2284000	Synchronization Point [SP10.3 - Start Community Testing Wave 3]	◆	0d	Mon 09/11/15	Mon 09/11/15	Eurosystem,CSDs, CBs														
2511	2284100	Connectivity Testing for Community wave 3	◆	40d	Tue 13/10/15	Mon 07/12/15															
2514	2285000	Community testing Wave 3	◆	125d	Mon 09/11/15	Wed 27/04/16															
2515	2286000	Community Testing Wave 3 [First Window]	◆	70d	Mon 09/11/15	Fri 12/02/16															
2516	2287000	Start Community Test Wave 3	◆	0d	Mon 09/11/15	Mon 09/11/15	Eurosystem,CSDs														
2517	2319800	Finish Community Test Wave 3	◆	0d	Wed 20/04/16	Wed 20/04/16	Eurosystem,CSDs														
2577	2345100	[Deliverable] - User Testing Stage Report (Wave 3) V3.3 [Community phase]	◆	0d	Wed 27/04/16	Wed 27/04/16	Eurosystem														
2578	2346000	DCP-DCAH Certification phase wave 3	◆	135d	Tue 22/12/15	Wed 22/06/16															
2581	2346300	[Deliverable] - Certification report for DCPs (Wave 3)	◆	0d	Fri 18/03/16	Fri 18/03/16	Eurosystem														
2584	2346700	[Deliverable] - Certification report for DCAH (Wave 3)	◆	0d	Fri 18/03/16	Fri 18/03/16	Eurosystem														
2585	2351100	Synchronization Point [SP11.3 - Start Business Day Testing Wave 3]	◆	0d	Wed 27/04/16	Wed 27/04/16	Eurosystem,CSDs, CBs														
2586	2352000	Business day test Wave 3	◆	40d	Wed 27/04/16	Wed 22/06/16															
2587	2353000	Start Business day test Wave 3	◆	0d	Wed 27/04/16	Wed 27/04/16	Eurosystem,CSDs														
2608	2389000	Finish Business day test Wave 3	◆	0d	Wed 15/06/16	Wed 15/06/16	Eurosystem,CSDs														
2610	2390200	[Deliverable] - User Testing Stage Report (Wave 3) V3.4 [Business day phase]	◆	0d	Wed 22/06/16	Wed 22/06/16	Eurosystem														
2611	2391000	Progress Report Wave 3 (recurrent task during UT phase End of User Testing Wave 3)	◆	10d	Fri 28/11/14	Thu 11/12/14															
2612	2391100	Preparation Progress Report Wave 3 (recurrent task)	◆	10d	Fri 28/11/14	Thu 11/12/14	CSDs, CBs														
2613	2391200	[Deliverable] - Progress Report Wave 3 (recurrent task)	◆	0d	Thu 11/12/14	Thu 11/12/14	CSDs, CBs														
2614	2394400	Support Testing for other waves	◆	161d	Thu 05/03/15	Wed 14/10/15															
2615	2394500	Support Community Test of wave 1	◆	75d	Thu 05/03/15	Thu 18/06/15	CSDs														
2616	2394600	Support Community Test of wave 2	◆	100d	Mon 01/06/15	Wed 14/10/15	CSDs														
2617	2394200	Synchronization Point [SP12.3 - End of User Testing Execution Phase Wave 3]	◆	0d	Wed 29/06/16	Wed 29/06/16	Eurosystem,CSDs, CBs														
2618	2394300	Defects and Release Management during UT phases	◆	452d	Mon 07/07/14	Wed 30/03/16	Eurosystem														
2619	1310100	CONTRACTUAL FRAMEWORK	◆	602d	Tue 01/09/09	Wed 31/12/11															
2748	1027100	OPERATIONAL READINESS	◆	1984d	Mon 15/06/09	Mon 30/01/17															
2749	1027200	NETWORK AND CONNECTIVITY	◆	1260d	Mon 15/06/09	Thu 24/04/14															
2750	1028100	NETWORK AND CONNECTIVITY	◆	1260d	Mon 15/06/09	Thu 24/04/14															
2809	1063480	Tender process for Value-Added Services (VA-NSPs)	◆	147d	Fri 08/07/11	Tue 31/01/12															

Task Task Critical Milestone Critical Task Project Summary Group By Summary

T2S Detailed Plan with Critical Path

ID	ID Number (Number 1)	Task Name	CSD/CB relevant activities	Duration	Start	Finish	Resource Group for PMG	2011		2012		2013		2014		2015		2016		2017	
								1st Half	2nd Half	1st Half	2nd Half	1st Half	2nd Half	1st Half	2nd Half	1st Half	2nd Half	1st Half	2nd Half	1st Half	2nd Half
2810	1063490	Publication of Selection Documents		0d	Fri 08/07/11	Fri 08/07/11	TPUC-Eurosystem														
2811	1059100	[Deliverable] - Tender for Network Connectivity (VAN)		0d	Fri 08/07/11	Fri 08/07/11	Eurosystem														
2814	1061100	Signature of Network Service Provider Agreement		0d	Tue 31/01/12	Tue 31/01/12	Eurosystem														
2815	1062000	<b>CSDs - Network Service Provider negotiations</b>		543d	Tue 28/02/12	Fri 11/04/14	Eurosystem														
2818	1063120	CSD: Network Agreement Contract signed	◆	0d	Fri 11/04/14	Fri 11/04/14	CSDs														
2821	1063190	CB: Network Agreement Contract signed	◆	0d	Fri 11/04/14	Fri 11/04/14	CBs														
2822	1060500	<b>Tender process for Dedicated line (DL-NSPs) (to be updated after PB meeting in June)</b>		498d	Tue 01/03/11	Thu 31/01/13	Eurosystem														
2823	1060600	Analysis with CSDs		23d	Tue 01/03/11	Thu 31/03/11	Eurosystem														
2829	1061000	Contract Signature for dedicated link	◆	0d	Thu 31/01/13	Thu 31/01/13	Eurosystem														
2837	1064100	<b>Implementation Phase 2 - VAN Network</b>		322d	Wed 01/08/12	Mon 04/11/13	Eurosystem														
2842	1067100	Start of VAN Networks connectivity tests with CSDs/CBs (Finish acceptance VAN Networks by 4CB)		0d	Mon 04/11/13	Mon 04/11/13	Eurosystem														
2843	1077300	<b>Implementation - Phase 2 - Dedicated Links</b>		196d	Fri 01/02/13	Mon 04/11/13	Eurosystem														
2847	1077700	Start of DL connectivity tests with DiGsAs		0d	Mon 04/11/13	Mon 04/11/13	Eurosystem														
2849	1037100	<b>Implementation - Phase 3 - Network - Connectivity Guides</b>		173d	Tue 30/04/13	Thu 02/01/14	Eurosystem														
2850	1038100	<b>Internal Eurosystem Preparation [Connectivity Guide]</b>		173d	Tue 30/04/13	Thu 02/01/14	Eurosystem														
2852	1042200	[Deliverable] - Connectivity Guide for VAN and Direct connectivity (Testing) V1.0	◆	0d	Tue 30/07/13	Tue 30/07/13	Eurosystem														
2855	1043100	[Deliverable] - Connectivity Guide for VAN and Direct connectivity V2.0	◆	0d	Thu 02/01/14	Thu 02/01/14	Eurosystem														
2856	1081100	<b>INFORMATION SECURITY</b>		1221d	Wed 01/09/10	Fri 29/05/15	Eurosystem														
2857	1082100	<b>INFORMATION SECURITY</b>		1221d	Wed 01/09/10	Fri 29/05/15	Eurosystem														
2858	1084280	<b>T2S Threat Catalogue</b>		508d	Mon 03/01/11	Thu 13/12/12	Eurosystem														
2859	1084290	<b>Internal Eurosystem Preparation [T2S Threat Catalogue]</b>		505d	Mon 03/01/11	Mon 10/12/12	Eurosystem														
2867	1091500	[Deliverable] - T2S Threat Catalogue		0d	Thu 13/12/12	Thu 13/12/12	Eurosystem														
2906	1107250	<b>Risk analysis on T2S Compliance with T2S Information Security policy [Risk evaluation table &amp; Risk treatment plan]</b>		197d	Wed 13/08/14	Fri 22/05/15	Eurosystem														
2907	1107260	<b>Internal Eurosystem Preparation [Risk analysis on T2S Compliance with T2S Information Security policy]</b>		197d	Wed 13/08/14	Fri 22/05/15	Eurosystem														
2920	1108100	[Deliverable] - Risk Analysis on T2S Compliance with T2S Information Security policy	◆	0d	Fri 22/05/15	Fri 22/05/15	Eurosystem														
2932	1109200	<b>OPERATIONS</b>		1275d	Thu 01/12/11	Wed 02/11/16	Eurosystem														
2933	1110100	<b>OPERATIONAL PROCEDURES</b>		1275d	Thu 01/12/11	Wed 02/11/16	Eurosystem														
2934	1111100	<b>Manual of Operational Procedures (MOP)</b>		1275d	Thu 01/12/11	Wed 02/11/16	Eurosystem														
2935	1111150	<b>Production MOP V1.0 (before starting User Test)</b>		616d	Thu 01/12/11	Thu 24/04/14	Eurosystem														
2936	1112050	<b>First set of review cycles</b>		348d	Thu 01/12/11	Mon 08/04/13	Eurosystem														
2937	1112100	<b>Internal Eurosystem Preparation [MOP v0.1]</b>		150d	Thu 01/12/11	Wed 27/06/12	Eurosystem														

Legend: Task (blue box), Milestone (black diamond), Critical Milestone (red diamond), Critical Task (red box), Project Summary (grey arrow), Group By Summary (grey arrow)



T2S Detailed Plan with Critical Path

31/10/2011

17 of 27

ID	ID Number (Number 1)	Task Name	CSD/CB relevant activities	Duration	Start	Finish	Resource Group for PMG	2011		2012		2013		2014		2015		2016		2017	
								1st Half	2nd Half	1st Half	2nd Half	1st Half	2nd Half	1st Half	2nd Half	1st Half	2nd Half	1st Half	2nd Half	1st Half	2nd Half
2942	1113500	First Market consultation on Manual of Operational Procedures (MOP)	◆	196d	Thu 28/06/12	Mon 04/04/13	Eurosystem														
2944	1114100	Submission MOP V0.1 to OMG (1st cycle)	◆	0d	Wed 11/07/12	Wed 11/07/12	Eurosystem			◆ 11/07/2012											
2945	1115150	ONG Meeting	◆	1d	Thu 12/07/12	Thu 12/07/12	ONG			◆ 12/07/2012											
2946	1115100	Review MOP V0.1 by ONG	◆	30d	Fri 13/07/12	Thu 23/08/12	ONG			◆ 13/07/2012	◆ 23/08/2012										
2948	1118100	Submission new version of MOP V0.2 to OMG (2th cycle)	◆	0d	Fri 19/10/12	Fri 19/10/12	Eurosystem			◆ 19/10/2012											
2949	1119150	ONG Meeting	◆	1d	Mon 22/10/12	Mon 22/10/12	ONG			◆ 22/10/2012	◆ 22/10/2012										
2950	1119100	Review MOP V0.2 by ONG	◆	30d	Tue 23/10/12	Mon 03/12/12	ONG			◆ 23/10/2012	◆ 03/12/2012										
2952	1119600	Submission MOP V0.3 to OMG (3th cycle)	◆	0d	Fri 18/01/13	Fri 18/01/13	Eurosystem			◆ 18/01/2013											
2953	1119700	ONG Meeting	◆	1d	Mon 21/01/13	Mon 21/01/13	ONG			◆ 21/01/2013	◆ 21/01/2013										
2954	1119800	Approval MOP V0.3 by ONG	◆	0d	Mon 21/01/13	Mon 21/01/13	ONG			◆ 21/01/2013											
2957	1122000	ONG Meeting after PB meeting	◆	1d	Tue 19/02/13	Tue 19/02/13	ONG			◆ 19/02/2013	◆ 19/02/2013										
2958	1123000	Submission MOP V0.3 to CSG	◆	0d	Tue 26/02/13	Tue 26/02/13	Eurosystem			◆ 26/02/2013											
2959	1123100	CSG Meeting for guidance on MOP V0.3	◆	1d	Fri 08/03/13	Fri 08/03/13	CSG			◆ 08/03/2013	◆ 08/03/2013										
2960	1123200	Submission MOP V0.3 to NECSG	◆	0d	Tue 26/02/13	Tue 26/02/13	Eurosystem			◆ 26/02/2013											
2961	1123300	NECSG Meeting for guidance on MOP V0.3	◆	1d	Mon 11/03/13	Mon 11/03/13	NCSG			◆ 11/03/2013											
2963	1124000	Second set of review cycles	◆	275d	Tue 12/03/13	Mon 07/04/14															
2966	1124300	Second Market consultation on Manual of Operational Procedures (MOP)	◆	215d	Tue 04/06/13	Mon 07/04/14															
2968	1125100	Submission MOP V0.4 to ONG (4th cycle)	◆	0d	Mon 09/09/13	Mon 09/09/13	Eurosystem			◆ 09/09/2013											
2969	1126100	Review MOP V0.4 by ONG	◆	20d	Tue 10/09/13	Tue 08/10/13	ONG			◆ 10/09/2013	◆ 08/10/2013										
2971	1127100	Submission MOP V1.0 to ONG (5th cycle)	◆	0d	Tue 12/11/13	Tue 12/11/13	Eurosystem			◆ 12/11/2013											
2972	1128100	ONG Meeting	◆	1d	Mon 18/11/13	Mon 18/11/13	ONG			◆ 18/11/2013	◆ 18/11/2013										
2973	1128200	Approval of MOP V1.0 by ONG	◆	0d	Mon 18/11/13	Mon 18/11/13	ONG			◆ 18/11/2013											
2976	1130200	ONG Meeting after PB	◆	1d	Tue 17/12/13	Tue 17/12/13	ONG			◆ 17/12/2013	◆ 17/12/2013										
2977	1130300	Submission MOP V1.0 to the CSG	◆	0d	Tue 24/12/13	Tue 24/12/13	Eurosystem			◆ 24/12/2013											
2978	1130400	CSG Meeting for approval of MOP V1.0	◆	1d	Thu 09/01/14	Thu 09/01/14	CSG			◆ 09/01/2014	◆ 09/01/2014										
2979	1130500	Submission MOP V1.0 to the NECSG	◆	0d	Tue 24/12/13	Tue 24/12/13	Eurosystem			◆ 24/12/2013											
2980	1130600	NECSG Meeting for approval of MOP V1.0	◆	1d	Mon 13/01/14	Mon 13/01/14	NCSG			◆ 13/01/2014	◆ 13/01/2014										
2983	1140100	(Deliverable) - Manual of Operational Procedures (MOP) V1.0 for Business Day Test wave 1	◆	0d	Thu 24/04/14	Thu 24/04/14	Eurosystem			◆ 24/04/2014	◆ 24/04/2014										
2984	1140200	Production MOP V1.2 (revised MOP V1.0 before Start Operation in T2S wave 1)	◆	18d	Tue 19/05/15	Thu 11/06/15															
2986	1144100	Submission MOP V1.2 before operations to ONG	◆	0d	Mon 01/06/15	Mon 01/06/15	Eurosystem			◆ 01/06/2015											
2987	1145100	Approval MOP V1.2 before operations by ONG	◆	0d	Mon 08/06/15	Mon 08/06/15	ONG			◆ 08/06/2015											

Legend: Task (blue box), Critical Milestone (red circle), Milestone (black diamond), Critical Task (red box), Project Summary (grey arrow), Group By Summary (grey arrow)

T2S Detailed Plan with Critical Path

31/10/2011

18 of 27

ID	ID Number (Number 1)	Task Name	CSD/CB relevant activities	Duration	Start	Finish	Resource Group for PMG	2011		2012		2013		2014		2015		2016		2017	
								1st Half	2nd Half	1st Half	2nd Half	1st Half	2nd Half	1st Half	2nd Half	1st Half	2nd Half	1st Half	2nd Half	1st Half	2nd Half
2988	1121100	(Deliverable) - Manual of Operational Procedures (MOP) V1.2 before Start Operation in T2S Wave 1	◆	0d	Thu 11/06/15	Thu 11/06/15	Eurosystem														
2989	1121200	Production MOP V1.3 (revised MOP V1.2 after Start Operation in T2S wave 1 and during Business Day Test wave 2)	◆	121d	Tue 21/07/15	Thu 07/01/16	Eurosystem														
2990	1121300	Monthly Telco (Recurring task)	◆	1d	Tue 21/07/15	Tue 21/07/15	Eurosystem														
2991	1121400	Quarterly meeting (Recurring task)	◆	1d	Wed 16/09/15	Wed 16/09/15	Eurosystem, CSDs, CBS														
2993	1143160	Submission MOP V1.3 after Start Operation in T2S wave 1 to ONG	◆	0d	Wed 30/09/15	Wed 30/09/15	Eurosystem														
2994	1143170	Approval MOP V1.3 after Start Operation in T2S wave 1 by ONG	◆	0d	Wed 07/10/15	Wed 07/10/15	ONG														
2995	1145200	(Deliverable) - Manual of Operational Procedures (MOP) V1.3 during Business Day Test Wave 2	◆	0d	Thu 07/01/16	Thu 07/01/16	Eurosystem														
2996	1145300	Production MOP V1.4 (revised MOP V1.3 after Start Operation in T2S wave 2 and during Business Day Test wave 3)	◆	50d	Thu 25/02/16	Mon 02/05/16	Eurosystem														
2997	1145400	Monthly Telco (Recurring task)	◆	1d	Thu 25/02/16	Thu 25/02/16	Eurosystem														
2998	1145450	Quarterly meeting (Recurring task)	◆	1d	Wed 06/04/16	Wed 06/04/16	Eurosystem, CSDs, CBS														
3000	1145600	Submission MOP V1.4 after Start Operation in T2S wave 2 to ONG	◆	0d	Wed 20/04/16	Wed 20/04/16	Eurosystem														
3001	1145700	Approval MOP V1.4 after Start Operation in T2S wave 2 by ONG	◆	0d	Wed 27/04/16	Wed 27/04/16	ONG														
3002	1145800	(Deliverable) - Manual of Operational Procedures (MOP) V1.4 during Business Day Test Wave 3	◆	0d	Mon 02/05/16	Mon 02/05/16	Eurosystem														
3003	1145900	Production MOP V2.0 (Operational activities after Start Operation in T2S wave 3)	◆	97d	Thu 23/06/16	Wed 02/11/16	Eurosystem														
3004	1145950	Monthly Telco (Recurring task)	◆	1d	Tue 16/08/16	Tue 16/08/16	Eurosystem														
3005	1145960	Quarterly meeting (Recurring task)	◆	1d	Wed 12/10/16	Wed 12/10/16	Eurosystem, CSDs, CBS														
3007	1146020	Submission MOP V2.0 after Start Operation in T2S wave 3 to ONG	◆	0d	Wed 26/10/16	Wed 26/10/16	Eurosystem														
3008	1146040	Approval MOP V2.0 after Start Operation in T2S wave 3 by ONG	◆	0d	Wed 02/11/16	Wed 02/11/16	ONG														
3009	1146050	(Deliverable) - Manual of Operational Procedures (MOP) V2.0 after start of operations in T2S of wave 3	◆	0d	Thu 23/06/16	Thu 23/06/16	Eurosystem														
3017	1110200	SERVICE LEVEL AGREEMENT		0d	Fri 30/12/11	Fri 30/12/11															
3018	1187100	MIGRATION		1956d	Thu 23/07/09	Mon 30/01/17															
3019	1187200	MIGRATION PREPARATION		1800d	Thu 23/07/09	Thu 30/06/16															
3027	1200100	Preparation phase		1337d	Mon 02/05/11	Thu 30/06/16															
3028	1201100	Processes and tools for Data Migration		244d	Mon 02/05/11	Thu 05/04/12															
3029	1201200	Internal Eurosystem Preparation (Processes and tools for Data Migration)		67d	Mon 02/05/11	Tue 02/08/11															
3033	1203400	Market consultation on Processes and tools for Data Migration	◆	122d	Wed 19/10/11	Thu 05/04/12															
3034	1204170	Meeting with CSDs/CBs	◆	1d	Wed 19/10/11	Wed 19/10/11	PMG														
3035	1204180	Feedbacks from CSDs/CBs	◆	15d	Thu 20/10/11	Wed 09/11/11	CSDs, CBS														
3037	1204210	Submission User Requirements for data migration tools to CSDs/CBs (1st review cycle)	◆	0d	Wed 23/11/11	Wed 23/11/11	Eurosystem														
3039	1204350	Feedbacks from CSDs/CBs	◆	20d	Fri 02/12/11	Thu 29/12/11	CSDs, CBS														
3041	1205200	Submission User Requirements for data migration tools to CSDs/CBs (2nd review cycle)	◆	0d	Thu 12/01/12	Thu 12/01/12	Eurosystem														

Task Critical Milestone Critical Task Project Summary Group By Summary

T2S Detailed Plan with Critical Path

31/10/2011

19 of 27

ID	ID Number (Number 1)	Task Name	CSD/CB relevant activities	Duration	Start	Finish	Resource Group for PMG	2011		2012		2013		2014		2015		2016		2017	
								1st Half	2nd Half	1st Half	2nd Half	1st Half	2nd Half	1st Half	2nd Half	1st Half	2nd Half	1st Half	2nd Half	1st Half	2nd Half
3043	120530	Feedbacks from CSDs/CBs	◆	10d	Wed 01/02/12	Tue 14/02/12	CSDs, CBs														
3049	1206100	[Deliverable] - User Requirements for data migration tools V1.0	◆	0d	Thu 05/04/12	Thu 05/04/12	Eurosystem														
3050	1207100	<b>Composition of Migration Waves &amp; Dates</b>	◆	116d	Fri 29/06/12	Mon 10/12/12	Eurosystem														
3051	1207150	Reception of Proposal of migration waves, plus migration dates for each CSD/CB (as part of the feasibility study)	◆	0d	Fri 29/06/12	Fri 29/06/12	CSDs, CBs														
3052	1207200	<b>Eurosystem consultation: review of CSDs proposal by the Eurosystem</b>	◆	71d	Fri 29/06/12	Mon 08/10/12	Eurosystem														
3053	1209100	Coordination by Eurosystem of proposal for the Composition of migration waves (incl. CSD/CBs views)	◆	26d	Fri 29/06/12	Fri 03/08/12	Eurosystem, CSDs, CBs														
3054	546350	[Deliverable] - Composition and Timing Migration Waves by CSDs/CBs	◆	0d	Fri 03/08/12	Fri 03/08/12	CSDs, CBs														
3055	1209130	Evaluation by Eurosystem of proposal for the timing of migration waves (incl. CSD/CBs views)	◆	40d	Mon 05/08/12	Fri 28/09/12	Eurosystem, CSDs, CBs														
3056	1209150	Confirmation of the Timing and Composition of Migration Waves by Eurosystem	◆	0d	Mon 08/10/12	Mon 08/10/12	Eurosystem														
3057	1209160	<b>Market Consultation on Composition of Migration Waves &amp; Dates (only whether CSDs proposal conflicts with migration criteria)</b>	◆	96d	Fri 27/07/12	Mon 10/12/12	Eurosystem														
3059	1209200	Submission revised proposal of Composition of migration waves & dates V 0.1 to MSG (1st review cycle)	◆	0d	Thu 09/08/12	Thu 09/08/12	Eurosystem														
3060	1209300	Migration Sub Group (MSG) Meeting	◆	1d	Tue 04/09/12	Tue 04/09/12	PMG														
3062	1209500	Submission Composition of migration waves & dates V0.2 to MSG (2nd review cycle)	◆	0d	Tue 11/09/12	Tue 11/09/12	Eurosystem														
3063	1209600	Migration Sub Group (MSG) Meeting	◆	1d	Wed 26/09/12	Wed 26/09/12	PMG														
3068	1211000	Submission Composition of migration waves & dates V1.0 to CSG	◆	0d	Mon 22/10/12	Mon 22/10/12	Eurosystem														
3069	1212000	CSG Meeting: approval of Composition of migration waves & dates V1.0	◆	1d	Tue 06/11/12	Tue 06/11/12	CGG														
3075	1218000	[Deliverable] - Confirmation of composition and timing of Migration Waves V1.0	◆	0d	Mon 10/12/12	Mon 10/12/12	Eurosystem														
3076	1218100	<b>Migration profiles &amp; Registration Guide</b>	◆	289d	Mon 03/10/11	Fri 09/11/12	Eurosystem														
3077	1218200	<b>Internal Eurosystem Preparation [Migration profiles &amp; Registration Guide]</b>	◆	95d	Mon 03/10/11	Fri 10/02/12	Eurosystem														
3080	1220400	<b>Market Consultation on Migration profiles &amp; Registration Guide</b>	◆	194d	Mon 13/02/12	Fri 09/11/12	Eurosystem														
3082	122200	Submission Migration profiles and Registration Guide V0.1 to MSG (1st review cycle)	◆	0d	Fri 23/03/12	Fri 23/03/12	Eurosystem														
3083	1222300	Migration Sub Group (MSG) Meeting	◆	1d	Mon 26/03/12	Mon 26/03/12	PMG														
3084	1222250	Review Migration profiles & Registration Guide V0.1 by MSG	◆	15d	Tue 27/03/12	Mon 16/04/12	ONG														
3086	1222500	Submission Migration profiles and Registration Guide V0.2 to MSG (2nd review cycle)	◆	0d	Mon 30/04/12	Mon 30/04/12	Eurosystem														
3087	1222600	Migration Sub Group (MSG) Meeting	◆	1d	Tue 01/05/12	Tue 01/05/12	PMG														
3088	1222650	Review Migration profiles & Registration Guide V0.2 by MSG	◆	15d	Wed 02/05/12	Tue 22/05/12	ONG														
3090	1222800	Submission Migration profiles and Registration Guide V0.3 to PMG	◆	0d	Tue 05/06/12	Tue 05/06/12	Eurosystem														
3091	1222900	Migration Sub Group (PMG) Meeting	◆	1d	Wed 06/06/12	Wed 06/06/12	PMG														
3092	1222950	Review Migration profiles & Registration Guide V0.2 by MSG	◆	15d	Thu 07/06/12	Wed 27/06/12	ONG														
3097	1221300	Submission to PMG Migration profiles and Registration Guide V0.5	◆	0d	Wed 01/08/12	Wed 01/08/12	Eurosystem														
3098	1221400	PMG Meeting	◆	1d	Thu 23/08/12	Thu 23/08/12	PMG														

Task Critical Milestone Critical Task Milestone Project Summary Group By Summary

T2S Detailed Plan with Critical Path

31/10/2011

ID	ID Number (Number 1)	Task Name	CSD/CB relevant activities	Duration	Start	Finish	Resource Group for PMG	2011		2012		2013		2014		2015		2016		2017	
								1st Half	2nd Half	1st Half	2nd Half	1st Half	2nd Half	1st Half	2nd Half	1st Half	2nd Half	1st Half	2nd Half	1st Half	2nd Half
3100	1221600	Submission to CSG Migration profiles and Registration Guide V1.0	◆	0d	Thu 30/08/12	Thu 30/08/12	Eurosystem														
3101	1221700	CSG Meeting	◆	1d	Fri 14/09/12	Fri 14/09/12	CSDs		14/09/2012												
3106	1222100	[Deliverable] - Registration Guide for Migration V1.0	◆	0d	Fri 09/11/12	Fri 09/11/12	Eurosystem			74	◆	09/11/2012									
3107	1228100	Standard Migration Plans (including fallback and Roll-back Procedures)	◆	464d	Mon 16/01/12	Fri 01/11/13															
3108	1228200	Internal Eurosystem Preparation (Standard Migration plans (including fallback and Roll-back Procedures))	◆	230d	Mon 16/01/12	Mon 03/12/12															
3113	1229500	Market consultation on Standard Migration plan and Tailored	◆	234d	Tue 04/12/12	Fri 01/11/13															
3115	1230200	Submission Standard Migration Plan and Tailored V0.1 (per CSD) to MSG (1st review cycle)	◆	0d	Fri 01/02/13	Fri 01/02/13	Eurosystem				◆	01/02/2013									
3116	1230300	Migration Sub Group (MSG) Meeting	◆	1d	Mon 04/02/13	Mon 04/02/13	PMG				04/02/2013										
3117	1230250	Review Standard Migration Plan and Tailored V0.1 by OMG	◆	15d	Tue 05/02/13	Mon 25/02/13	OMG				05/02/2013										
3119	1230500	Submission Standard Migration Plan V0.2 to MSG (2st review cycle)	◆	0d	Mon 18/03/13	Mon 18/03/13	Eurosystem					◆	18/03/2013								
3120	1230600	Migration Sub Group (MSG) Meeting	◆	1d	Tue 19/03/13	Tue 19/03/13	PMG					19/03/2013									
3121	1230550	Review Standard Migration Plan and Tailored V0.1 by OMG	◆	15d	Wed 20/03/13	Tue 09/04/13	OMG				20/03/2013										
3123	1230800	Submission Standard Migration Plan V0.3 to PMG (3st review cycle)	◆	0d	Tue 30/04/13	Tue 30/04/13	Eurosystem					◆	30/04/2013								
3124	1230900	Migration Sub Group (PMG) Meeting	◆	1d	Wed 01/05/13	Wed 01/05/13	PMG				01/05/2013										
3125	1230850	Review Standard Migration Plan and Tailored V0.1 by OMG	◆	15d	Thu 02/05/13	Wed 22/05/13	OMG				02/05/2013										
3127	1231100	Submission Standard Migration Plan V0.4 to MSG (4st review cycle)	◆	0d	Wed 05/06/13	Wed 05/06/13	Eurosystem					◆	05/06/2013								
3128	1231200	Migration Sub Group (MSG) Meeting	◆	1d	Thu 06/06/13	Thu 06/06/13	PMG					06/06/2013									
3129	1231150	Review Standard Migration Plan and Tailored V0.1 by OMG	◆	15d	Fri 07/06/13	Thu 27/06/13	OMG					07/06/2013									
3134	1232000	Submission to PMG Standard Migration Plan and Tailored V0.6 (per CSD)	◆	0d	Wed 24/07/13	Wed 24/07/13	Eurosystem					◆	24/07/2013								
3135	1232100	PMG Meeting	◆	1d	Wed 07/08/13	Wed 07/08/13	PMG					07/08/2013									
3137	1232300	Submission to CSG Standard Migration Plan and Tailored V1.0 (per CSD)	◆	0d	Wed 14/08/13	Wed 14/08/13	Eurosystem					◆	14/08/2013								
3138	1232400	CSG Meeting	◆	1d	Tue 27/08/13	Tue 27/08/13	CSG					27/08/2013									
3143	1232800	[Deliverable] - Standard Migration Plan V1.0	◆	0d	Fri 01/11/13	Fri 01/11/13	Eurosystem						◆	01/11/2013							
3144	1232900	Migration Weekend Script (including fallback and Roll-back Procedures)	◆	797d	Mon 03/06/13	Thu 30/06/16															
3145	1233000	Internal Eurosystem Preparation (Migration Weekend Script for wave 1)	◆	150d	Mon 03/06/13	Fri 03/01/14															
3150	1233340	Market consultation on Migration Weekend Script	◆	230d	Mon 06/01/14	Tue 25/11/14															
3152	1233400	Submission Detailed migration script V0.1 for each migration group to MSG (1st review cycle)	◆	0d	Fri 28/03/14	Fri 28/03/14	Eurosystem														◆
3153	1233500	Migration Sub Group (MSG) Meeting	◆	1d	Mon 31/03/14	Mon 31/03/14	PMG														◆
3154	1233450	Review Detailed migration script V0.1 by OMG	◆	15d	Tue 01/04/14	Mon 21/04/14	OMG														◆
3156	1233700	Submission Detailed migration script V0.2 for each migration group to MSG (2st review cycle)	◆	0d	Tue 06/05/14	Tue 06/05/14	Eurosystem														◆
3157	1233800	Migration Sub Group (MSG) Meeting	◆	1d	Wed 07/05/14	Wed 07/05/14	PMG														◆

Legend: Task (blue box), Critical Milestone (red circle), Milestone (black diamond), Critical Task (red box), Project Summary (grey arrow), Group By Summary (grey arrow)

T2S Detailed Plan with Critical Path

31/10/2011

ID	ID Number (Number 1)	Task Name	CSD/CB relevant activities	Duration	Start	Finish	Resource Group for PMG	2011		2012		2013		2014		2015		2016		2017	
								1st Half	2nd Half	1st Half	2nd Half	1st Half	2nd Half	1st Half	2nd Half	1st Half	2nd Half	1st Half	2nd Half	1st Half	2nd Half
3158	1233850	Review Detailed migration script V0.2 by OMG	◆	15d	Thu 08/05/14	Wed 28/05/14	OMG														
3160	1234000	Submission Detailed migration script V0.3 for each migration group to PMG (3rd review cycle)	◆	0d	Wed 11/06/14	Wed 11/06/14	Eurosystem														
3161	1234100	Migration Sub Group (MSG) Meeting	◆	1d	Thu 12/06/14	Thu 12/06/14	PMG														
3162	1234150	Review Detailed migration script V0.3 by OMG	◆	15d	Fri 13/06/14	Thu 03/07/14	OMG														
3164	1234300	Submission Detailed migration script V0.4 for each migration group to T2S Board	◆	0d	Thu 17/07/14	Thu 17/07/14	Eurosystem														
3165	1234400	PB Meeting	◆	2d	Fri 01/08/14	Mon 04/08/14	PMG														
3167	1234600	Submission to PMG of Detailed migration script V0.5 for each migration group	◆	0d	Thu 14/08/14	Thu 14/08/14	Eurosystem														
3168	1234700	PMG Meeting	◆	1d	Fri 05/09/14	Fri 05/09/14	PMG														
3170	1234900	Submission to CSG of Detailed migration script V1.0 for each migration group	◆	0d	Fri 12/09/14	Fri 12/09/14	Eurosystem														
3171	1235000	CSG Meeting	◆	1d	Thu 02/10/14	Thu 02/10/14	CSG														
3176	1235400	[Deliverable] - Detailed Migration Weekend Script V1.0 Wave 1	◆	0d	Fri 28/11/14	Fri 28/11/14	Eurosystem														
3177	1235500	Review Migration Weekend Script for wave 1 before Start Operation in T2S	◆	31d	Fri 24/04/15	Mon 08/06/15	Eurosystem														
3179	1235650	Market consultation Migration Weekend Script for wave 1 before Start Operation in T2S	◆	21d	Fri 08/05/15	Mon 08/06/15	Eurosystem														
3180	1235700	Submission Detailed migration script V1.1 for migration wave 1	◆	0d	Fri 08/05/15	Fri 08/05/15	Eurosystem														
3181	1235800	Migration Sub Group (MSG) Meeting	◆	1d	Mon 01/06/15	Mon 01/06/15	PMG														
3183	1236000	[Deliverable] - Detailed Migration Weekend Script V1.2 Wave 1	◆	0d	Mon 08/06/15	Mon 08/06/15	Eurosystem														
3184	1236400	Internal Eurosystem Preparation [Migration Weekend Script for wave 2]	◆	90d	Mon 02/03/15	Thu 02/07/15	Eurosystem														
3187	1236640	Market consultation Migration Weekend Script for wave 2	◆	92d	Fri 03/07/15	Mon 09/11/15	Eurosystem														
3189	1236700	Submission Detailed migration script V2.0 for migration wave 2	◆	0d	Thu 30/07/15	Thu 30/07/15	Eurosystem														
3190	1236800	Migration Sub Group (MSG) Meeting	◆	1d	Fri 21/08/15	Fri 21/08/15	PMG														
3192	1237000	Submission draft version of Detailed migration script V2.1 for migration wave 2 to MSG	◆	0d	Fri 18/09/15	Fri 18/09/15	Eurosystem														
3193	1237100	Migration Sub Group (MSG) Meeting	◆	1d	Mon 12/10/15	Mon 12/10/15	PMG														
3196	1237300	[Deliverable] - Detailed Migration Weekend Script V2.2 Wave 2	◆	0d	Mon 09/11/15	Mon 09/11/15	Eurosystem														
3197	1237350	Review Migration Weekend Script for wave 2 before Start Operation in T2S wave 2	◆	26d	Wed 09/12/15	Thu 14/01/16	Eurosystem														
3199	1237450	Market consultation Migration Weekend Script for wave 2 before Start Operation in T2S	◆	16d	Tue 22/12/15	Thu 14/01/16	Eurosystem														
3200	1237520	Submission draft version of Detailed migration script V2.3 for migration wave 2	◆	0d	Tue 22/12/15	Tue 22/12/15	Eurosystem														
3201	1235820	Migration Sub Group (MSG) Meeting	◆	1d	Thu 07/01/16	Thu 07/01/16	PMG														
3203	1236020	[Deliverable] - Detailed Migration Weekend Script V2.4 Wave 2	◆	0d	Thu 14/01/16	Thu 14/01/16	Eurosystem														
3204	1237400	Internal Eurosystem Preparation [Migration Weekend Script for wave 3]	◆	80d	Thu 20/08/15	Wed 09/12/15	Eurosystem														
3207	1237540	Market consultation on Migration Weekend Script for wave 3	◆	149d	Thu 10/12/15	Thu 30/06/16	Eurosystem														
3209	1237600	Submission draft version of Detailed migration script V3.0 for migration wave 3	◆	0d	Thu 07/01/16	Thu 07/01/16	Eurosystem														

Task Critical Milestone Critical Task Project Summary Group By Summary

T2S Detailed Plan with Critical Path  
31/10/2011

ID	ID Number (Number 1)	Task Name	CSD/CB relevant activities	Duration	Start	Finish	Resource Group for PMG	2011				2012				2013				2014				2015				2016			
								1st Half	2nd Half	1st Half	2nd Half	1st Half	2nd Half	1st Half	2nd Half	1st Half	2nd Half	1st Half	2nd Half	1st Half	2nd Half	1st Half	2nd Half	1st Half	2nd Half	1st Half	2nd Half	1st Half	2nd Half	1st Half	2nd Half
								Qtr 1	Qtr 2	Qtr 3	Qtr 4	Qtr 1	Qtr 2	Qtr 3	Qtr 4	Qtr 1	Qtr 2	Qtr 3	Qtr 4	Qtr 1	Qtr 2	Qtr 3	Qtr 4	Qtr 1	Qtr 2	Qtr 3	Qtr 4	Qtr 1	Qtr 2	Qtr 3	Qtr 4
3210	1237700	Migration Sub Group (MSG) Meeting	◆	1d	Fri 29/01/16	Fri 29/01/16	PMG																								
3212	1237900	Submission draft version of Detailed migration script V3.1 for migration wave 3 to MSG	◆	0d	Wed 24/02/16	Wed 24/02/16	Eurosystem																								
3213	1238000	Migration Sub Group (MSG) Meeting	◆	1d	Thu 17/03/16	Thu 17/03/16	PMG																								
3216	1238200	[Deliverable] - Detailed Migration Weekend Script V3.2 Wave 3	◆	0d	Tue 12/04/16	Tue 12/04/16	Eurosystem																								
3217	1234650	<b>Review Migration Weekend Script for wave 3 before Start Operation in T2S wave 3</b>	◆	26d	Thu 26/05/16	Thu 30/06/16																									
3219	1235710	<b>Market consultation Migration Weekend Script for wave 3 before Start Operation in T2S</b>	◆	16d	Wed 08/06/16	Thu 30/06/16																									
3220	1235740	Submission draft version of Detailed migration script V3.3 for migration wave 3	◆	0d	Wed 08/06/16	Wed 08/06/16	Eurosystem																								
3221	1235840	Migration Sub Group (MSG) Meeting	◆	1d	Thu 23/06/16	Thu 23/06/16	PMG																								
3223	1236040	[Deliverable] - Detailed Migration Weekend Script V3.4 Wave 3	◆	0d	Thu 30/06/16	Thu 30/06/16	Eurosystem																								
3239	1269100	<b>PRE-MIGRATION TASKS (WAVE 1)</b>		255d	Fri 20/06/14	Fri 19/06/15																									
3240	1235410	<b>Implementation Migration phase (wave 1)</b>		80d	Mon 17/11/14	Thu 12/03/15																									
3241	1244100	<b>Preparation of Migration Weekend (wave 1)</b>		80d	Mon 17/11/14	Thu 12/03/15																									
3242	124410	Start preparation of Migration Weekend	◆	0d	Mon 01/12/14	Mon 01/12/14	Eurosystem																								
3243	1245100	<b>[Predecessors] Preparation of Production Environment</b>		10d	Mon 01/12/14	Fri 12/12/14																									
3244	387100	Network ready for Production		0d	Mon 01/12/14	Mon 01/12/14	Eurosystem																								
3246	1246200	Collection of Registration Forms from CSDs / CBs (wave 1 + CSDs/CBs with Common Static Data)	◆	10d	Mon 01/12/14	Fri 12/12/14	Eurosystem																								
3247	1247100	Registration form filled in (wave 1 + CSDs/CBs with Common Static Data)	◆	0d	Fri 12/12/14	Fri 12/12/14	CSDs,CBs																								
3248	1249100	<b>Preparation of production environment</b>		80d	Mon 17/11/14	Thu 12/03/15																									
3249	1258200	T2S helpdesk is operational and contact details have been communicated to all relevant T2S parties	◆	0d	Mon 17/11/14	Mon 17/11/14	Eurosystem																								
3250	1250100	<b>Synchronization Point [SP13 - Eurosystem ready for Production]</b>	◆	0d	Mon 01/12/14	Mon 01/12/14	Eurosystem																								
3253	1251150	Input Registration Data completed	◆	0d	Thu 29/01/15	Thu 29/01/15	Eurosystem																								
3254	1256100	PROD environment available for users	◆	0d	Thu 05/02/15	Thu 05/02/15	Eurosystem																								
3255	1255200	Completed network registration by CSDs (wave 1)	◆	0d	Thu 05/02/15	Thu 05/02/15	CSDs																								
3256	1255300	Completed network registration by CBs (wave 1)	◆	0d	Thu 05/02/15	Thu 05/02/15	CBs																								
3257	1257100	<b>Synchronization Point [SP14.1 - Ready to connect to Production wave 1]</b>	◆	0d	Thu 05/02/15	Thu 05/02/15	Eurosystem,CSDs																								
3258	1255100	Prod Connectivity testing (wave 1)	◆	20d	Fri 13/02/15	Thu 12/03/15	CSDs																								
3259	1263100	Successful connectivity tests CSD (wave 1)	◆	0d	Thu 12/03/15	Thu 12/03/15	CSDs																								
3260	1255400	Successful connectivity tests CB (wave 1)	◆	0d	Thu 12/03/15	Thu 12/03/15	CBs																								
3266	1272100	<b>Synchronization Point [SP15.1 - Ready to upload Static Data wave 1]</b>	◆	0d	Thu 19/03/15	Thu 19/03/15	Eurosystem,CSDs																								
3268	1268200	<b>Migration Common Static Data</b>	◆	105d	Fri 23/01/15	Fri 19/06/15																									
3269	1268300	Start Static Data identification and collection (for all CSDs/CBs with Common Static Data)	◆	0d	Fri 23/01/15	Fri 23/01/15	CSDs,CBs																								

Task

Task Milestone

Critical Milestone

Critical Task

Milestone

Project Summary

Group By Summary

22

T2S Detailed Plan with Critical Path  
31/10/2011

ID	ID Number (Number 1)	Task Name	CSD/CB relevant activities	Duration	Start	Finish	Resource Group for PMG	2011				2012				2013				2014				2015				2016				2017							
								1st Half Qtr 1	2nd Half Qtr 2	1st Half Qtr 3	2nd Half Qtr 4	1st Half Qtr 1	2nd Half Qtr 2	1st Half Qtr 3	2nd Half Qtr 4	1st Half Qtr 1	2nd Half Qtr 2	1st Half Qtr 3	2nd Half Qtr 4	1st Half Qtr 1	2nd Half Qtr 2	1st Half Qtr 3	2nd Half Qtr 4	1st Half Qtr 1	2nd Half Qtr 2	1st Half Qtr 3	2nd Half Qtr 4	1st Half Qtr 1	2nd Half Qtr 2	1st Half Qtr 3	2nd Half Qtr 4	1st Half Qtr 1	2nd Half Qtr 2	1st Half Qtr 3	2nd Half Qtr 4				
3270	1268400	Relevant Static Data ready by CSDs (for all CSDs with Common Static Data)	◆	0d	Thu 05/03/15	Thu 05/03/15	CSDs	◆	◆	◆	◆																												
3271	1268500	Relevant Static Data ready by CBs (for all CBs with Common Static Data)	◆	0d	Thu 05/03/15	Thu 05/03/15	CBs																																
3272	1268600	T2S System Configuration parameters finalised	◆	0d	Thu 29/01/15	Thu 29/01/15	EGs, A-CB																																
3273	1268700	Common Static Data input by CSDs and CBs and Maintenance Static Data (for all CSDs/CBs with Common Static Data)	◆	65d	Fri 20/03/15	Fri 19/06/15	CBs, CSDs, Eurosystem																																
3275	1269200	Migration Proprietary Static Data (wave 1)	◆	105d	Fri 23/01/15	Fri 19/06/15	CBs, CSDs, Eurosystem																																
3276	1270100	Start Static Data Identification and collection (wave 1)	◆	0d	Fri 23/01/15	Fri 23/01/15	CSDs, CBs																																
3277	1271200	Relevant Static Data ready by CSDs (wave1)	◆	0d	Thu 05/03/15	Thu 05/03/15	CSDs																																
3278	1271300	Relevant Static Data ready by CBs (wave1)	◆	0d	Thu 05/03/15	Thu 05/03/15	CBs																																
3279	1270400	T2S System Configuration parameters finalised	◆	0d	Thu 29/01/15	Thu 29/01/15	Eurosystem																																
3280	1273100	Proprietary Static Data input by CSDs and CBs and Maintenance Static Data (wave 1)	◆	65d	Fri 20/03/15	Fri 19/06/15	CBs, CSDs, Eurosystem																																
3282	1275000	MIGRATION WEEKEND (WAVE 1)	◆	48d	Fri 22/05/15	Mon 27/07/15	CSDs, CBs																																
3283	1272200	Final verification of the list of showstoppers wave 1 (dependencies with local regulator)	◆	0d	Fri 22/05/15	Fri 22/05/15	CSDs, CBs																																
3284	1277000	Confirmation that migration script has been integrated in internal plans (wave 1)	◆	0d	Fri 12/06/15	Fri 12/06/15	CSDs, CBs																																
3285	1277200	Internal staff trained for change-over Weekend and operations (wave 1)	◆	0d	Thu 18/06/15	Thu 18/06/15	CSDs, CBs																																
3286	1277300	Confirmation that internal control mechanisms are in place (wave 1)	◆	0d	Fri 05/06/15	Fri 05/06/15	CSDs, CBs																																
3287	1277400	External communication has been rolled-out (wave 1)	◆	0d	Fri 05/06/15	Fri 05/06/15	CSDs, CBs																																
3288	1275100	Synchronization Point [SP16.1 - Ready for T2S Go-Live (Wave 1)]	◆	0d	Fri 19/06/15	Fri 19/06/15	CSDs, CBs, Eurosystem																																
3289	1276100	Dynamic data upload by CSDs/CBs	◆	2d	Sat 20/06/15	Sun 21/06/15	Eurosystem, CSDs																																
3290	1279100	Wave 1 Start Operations in T2S	◆	0d	Mon 22/06/15	Mon 22/06/15	Eurosystem, CSDs																																
3291	1279200	Migration closing phase Wave 1	◆	15d	Tue 07/07/15	Mon 27/07/15	Eurosystem																																
3294	835100	[Deliverable] - End of Migration Report (Wave 1)	◆	0d	Mon 27/07/15	Mon 27/07/15	Eurosystem																																
3295	1280200	PRE-MIGRATION TASKS (WAVE 2)	◆	416d	Fri 20/06/14	Fri 29/01/16																																	
3296	1281000	Implementation Migration phase (wave 2)	◆	55d	Mon 17/08/15	Fri 30/10/15																																	
3297	1281100	Preparation of Migration Weekend (wave 2)	◆	55d	Mon 17/08/15	Fri 30/10/15																																	
3298	1281200	Start preparation of Migration Weekend (wave 2)	◆	0d	Mon 17/08/15	Mon 17/08/15	Eurosystem																																
3299	1281300	[Predecessors] Preparation of Production Environment	◆	20d	Mon 17/08/15	Fri 11/09/15																																	
3300	1281400	Collection of Registration Forms from CSDs/CBs (wave 2)	◆	20d	Mon 17/08/15	Fri 11/09/15	Eurosystem																																
3301	1281500	Registration form filled in (CSDs/CBs) (wave 2)	◆	0d	Fri 11/09/15	Fri 11/09/15	CSDs, CBs																																
3302	1281600	Preparation of production environment	◆	35d	Mon 14/09/15	Fri 30/10/15																																	
3305	1283400	PROD environment available for users	◆	0d	Fri 02/10/15	Fri 02/10/15	Eurosystem																																
3306	1283350	Completed network registration by CSDs (wave 2)	◆	0d	Fri 02/10/15	Fri 02/10/15	CSDs																																

Legend: Task, Milestone, Critical Milestone, Critical Task, Project Summary, Group By Summary

T2S Detailed Plan with Critical Path

31/10/2011

ID	ID Number (Number 1)	Task Name	CSD/CB relevant activities	Duration	Start	Finish	Resource Group for PMG	2011		2012		2013		2014		2015		2016		2017		
								1st Half	2nd Half	1st Half	2nd Half	1st Half	2nd Half	1st Half	2nd Half	1st Half	2nd Half	1st Half	2nd Half			
								Qtr.1	Qtr.2	Qtr.3	Qtr.4	Qtr.1	Qtr.2	Qtr.3	Qtr.4	Qtr.1	Qtr.2	Qtr.3	Qtr.4	Qtr.1	Qtr.2	
3307	128380	Completed network registration by CBS (wave 2)	◆	0d	Fri 02/10/15	Fri 02/10/15	CBS															
3308	1283700	T2S helpdesk is operational and contact details have been communicated to all relevant T2S parties	◆	0d	Mon 21/09/15	Mon 21/09/15	Eurosystem															
3309	1283500	<b>Synchronization Point [SP14.2 - Ready to connect to Production wave 2]</b>	◆	0d	Fri 02/10/15	Fri 02/10/15	Eurosystem,CSDs															
3310	1283300	Prod Connectivity testing (wave 2)	◆	20d	Mon 05/10/15	Fri 30/10/15	CSDs															
3311	1283370	Successful connectivity tests CSD (wave 2)	◆	0d	Fri 30/10/15	Fri 30/10/15	CSDs															
3312	1283390	Successful connectivity tests CB (wave 2)	◆	0d	Fri 30/10/15	Fri 30/10/15	CBS															
3318	<b>1283100</b>	<b>Migration Proprietary Static Data (wave 2)</b>	◆	<b>158d</b>	<b>Tue 23/06/15</b>	<b>Fri 29/01/16</b>																
3319	1282100	Common Static Data Maintenance (Production System)	◆	140d	Tue 23/06/15	Tue 05/01/16	Eurosystem,CSDs															
3320	1284150	Start Static Data Identification and collection (wave 2)	◆	0d	Mon 14/09/15	Mon 14/09/15	CSDs,CBS															
3321	1284200	Relevant Static Data ready CSD (wave 2)	◆	0d	Fri 09/10/15	Fri 09/10/15	CSDs															
3322	1284300	Relevant Static Data ready CB (wave 2)	◆	0d	Fri 09/10/15	Fri 09/10/15	CBS															
3323	1285200	<b>Synchronization Point [SP15.2 - Ready to upload Static Data wave 2]</b>	◆	0d	Fri 06/11/15	Fri 06/11/15	Eurosystem,CSDs															
3324	1286100	Proprietary Static Data input by CSDs and CBS and Maintenance Static Data	◆	59d	Mon 09/11/15	Fri 29/01/16	Eurosystem,CSDs															
3326	<b>1287000</b>	<b>MIGRATION WEEKEND (WAVE 2)</b>	◆	<b>48d</b>	<b>Fri 01/01/16</b>	<b>Mon 07/03/16</b>																
3327	1287050	Final verification of the list of showstoppers wave 3 (dependencies with local legislation)	◆	0d	Fri 01/01/16	Fri 01/01/16	CSDs															
3328	1287200	Confirmation that migration script has been integrated in internal plans (Wave 2)	◆	0d	Fri 22/01/16	Fri 22/01/16	CSDs,CBS															
3329	1287200	Internal staff trained for change-over Weekend and operations (Wave 2)	◆	0d	Thu 28/01/16	Thu 28/01/16	CSDs,CBS															
3330	1287400	Confirmation that internal control mechanisms are in place (Wave 2)	◆	0d	Fri 15/01/16	Fri 15/01/16	CSDs,CBS															
3331	1287500	External communication has been rolled-out (Wave 2)	◆	0d	Fri 15/01/16	Fri 15/01/16	CSDs,CBS															
3332	1287100	<b>Synchronization Point [SP16.2 - Ready for Migration Wave 2]</b>	◆	0d	Fri 29/01/16	Fri 29/01/16	Eurosystem,CSDs															
3333	1286100	Dynamic data upload	◆	2d	Sat 30/01/16	Sun 31/01/16	Eurosystem,CSDs															
3334	1291100	<b>Wave 2 Start Operations in T2S</b>	◆	0d	Mon 01/02/16	Mon 01/02/16	Eurosystem,CSDs															
3335	<b>1291200</b>	<b>Migration closing phase Wave 2</b>	◆	<b>15d</b>	<b>Tue 16/02/16</b>	<b>Mon 07/03/16</b>																
3338	1025100	[Deliverable] - End of Migration Report (Wave 2)	◆	0d	Mon 07/03/16	Mon 07/03/16	Eurosystem															
3339	<b>1293000</b>	<b>PRE-MIGRATION TASKS (WAVE 3)</b>	◆	<b>543d</b>	<b>Fri 20/06/14</b>	<b>Mon 18/07/16</b>																
3340	<b>1293100</b>	<b>Implementation Migration phase (wave 3)</b>	◆	<b>475d</b>	<b>Fri 20/06/14</b>	<b>Fri 15/04/16</b>																
3341	<b>1293200</b>	<b>Preparation of Migration Weekend (wave 3)</b>	◆	<b>52d</b>	<b>Mon 08/02/16</b>	<b>Fri 15/04/16</b>																
3342	1293300	Start preparation of Migration Weekend (wave 3)	◆	0d	Mon 08/02/16	Mon 08/02/16	Eurosystem															
3343	<b>1293400</b>	<b>[Predecessors] Preparation of Production Environment</b>	◆	<b>20d</b>	<b>Mon 08/02/16</b>	<b>Fri 04/03/16</b>																
3344	1293500	Collection of Registration Forms from CSDs/CBS (wave 3)	◆	20d	Mon 08/02/16	Fri 04/03/16	Eurosystem															
3345	1293600	Registration form filled in (CSDs/CBS) (wave 3)	◆	0d	Fri 04/03/16	Fri 04/03/16	CSDs,CBS															

Task Critical Milestone Milestone Critical Task Group By Summary Project Summary



T2S Detailed Plan with Critical Path

31/10/2011

ID	ID Number (Number 1)	Task Name	CSD/CB relevant activities	Duration	Start	Finish	Resource Group for PMG											
							2011	2012	2013	2014	2015	2016	2017					
					1st Half	2nd Half	1st Half	2nd Half	1st Half	2nd Half	1st Half	2nd Half	1st Half	2nd Half	1st Half	2nd Half		
					Oct.1	Oct.2	Oct.1	Oct.2	Oct.1	Oct.2	Oct.1	Oct.2	Oct.1	Oct.2	Oct.1	Oct.2		
3346	1293700	Preparation of production environment		32d	Mon 07/03/16	Fri 15/04/16												
3349	1294500	PROD environment available for users		0d	Tue 22/03/16	Tue 22/03/16	Eurosystem											
3350	1294200	Completed network registration by CSDs (wave 3)		0d	Tue 22/03/16	Tue 22/03/16	CSDs											
3351	1294350	Completed network registration by CBs (wave 3)		0d	Tue 22/03/16	Tue 22/03/16	CBs											
3352	1294800	T2S helpdesk is operational and contact details have been communicated to all relevant T2S parties		0d	Wed 09/03/16	Wed 09/03/16	Eurosystem											
3353	1294600	Synchronization Point [SP14.3 - Ready to connect to Production wave 3]		0d	Tue 22/03/16	Tue 22/03/16	Eurosystem,CSDs											
3354	1294400	Prod Connectivity testing (wave 3)		20d	Wed 23/03/16	Fri 15/04/16	CSDs											
3355	1294300	Successful connectivity tests CSD (wave 3)		0d	Fri 15/04/16	Fri 15/04/16	CSDs											
3356	1294370	Successful connectivity tests CB (wave 3)		0d	Fri 15/04/16	Fri 15/04/16	CBs											
3362	1296100	Migration Proprietary Static Data (wave 3)		125d	Mon 01/02/16	Mon 18/07/16												
3363	1296200	Common Static Data Maintenance (Production System)		120d	Mon 01/02/16	Wed 13/07/16	Eurosystem,CSDs											
3364	1297150	Start Static Data Identification and collection (wave 3)		0d	Wed 02/03/16	Wed 02/03/16	CSDs, CBs											
3365	1297200	Relevant Static Data ready CSD (wave 3)		0d	Sun 27/03/16	Sun 27/03/16	CSDs											
3366	1297300	Relevant Static Data ready CB (wave 3)		0d	Sun 27/03/16	Sun 27/03/16	CBs											
3367	1298200	Synchronization Point [SP15.3 - Ready to upload Static Data]		0d	Fri 22/04/16	Fri 22/04/16	Eurosystem,CSDs											
3368	1299100	Proprietary Static Data input by CSDs and CBs and Maintenance Static Data		60d	Mon 25/04/16	Fri 15/07/16	Eurosystem,CSDs											
3370	1299200	MIGRATION WEEKEND (WAVE 3)		83d	Fri 17/06/16	Mon 10/10/16												
3371	1299250	Final verification of the list of showstoppers wave 3 (dependencies with local legislation)		0d	Fri 17/06/16	Fri 17/06/16	CSDs											
3372	1299300	Confirmation that migration script has been integrated in internal plans (Wave 3)		0d	Fri 08/07/16	Fri 08/07/16	CSDs, CBs											
3373	1299400	Internal staff trained for change-over Weekend and operations (Wave 3)		0d	Thu 14/07/16	Thu 14/07/16	CSDs, CBs											
3374	1299500	Confirmation that internal control mechanisms are in place (Wave 3)		0d	Fri 01/07/16	Fri 01/07/16	CSDs, CBs											
3375	1299600	External communication has been rolled-out (Wave 3)		0d	Fri 01/07/16	Fri 01/07/16	CSDs, CBs											
3376	1300100	Synchronization Point [SP16.3 - Ready for Migration Wave 3]		0d	Fri 15/07/16	Fri 15/07/16	Eurosystem,CSDs											
3377	1301100	Dynamic data upload		2d	Sat 16/07/16	Sun 17/07/16	Eurosystem,CSDs											
3378	1304100	Wave 3 Start Operations in T2S		0d	Mon 18/07/16	Mon 18/07/16	Eurosystem,CSDs											
3379	1304200	Migration closing phase Wave 3		15d	Tue 02/08/16	Mon 22/08/16												
3382	1294000	[Deliverable] - End of Migration Report (Wave 3)		0d	Mon 22/08/16	Mon 22/08/16	Eurosystem											
3383	1309900	Closing phase		60d	Tue 19/07/16	Mon 10/10/16												
3384	1310000	Post-launch Assessment		60d	Tue 19/07/16	Mon 10/10/16	Eurosystem											
3385	1311000	Post-launch Support-Assessment		60d	Tue 19/07/16	Mon 10/10/16	Eurosystem											
3386	1312000	Report on the result of each wave		60d	Tue 19/07/16	Mon 10/10/16	Eurosystem											

Task Critical Milestone Critical Task Milestone Project Summary Group By Summary

ID	ID Number (Number 1)	Task Name	CSD/CB relevant activities	Duration	Start	Finish	2011			2012			2013			2014			2015			2016			2017									
							1st Half	2nd Half		1st Half	2nd Half		1st Half	2nd Half		1st Half	2nd Half		1st Half	2nd Half		1st Half	2nd Half		1st Half	2nd Half		1st Half	2nd Half					
							Qtr 1	Qtr 2	Qtr 3	Qtr 4	Qtr 1	Qtr 2	Qtr 3	Qtr 4	Qtr 1	Qtr 2	Qtr 3	Qtr 4	Qtr 1	Qtr 2	Qtr 3	Qtr 4	Qtr 1	Qtr 2	Qtr 3	Qtr 4	Qtr 1	Qtr 2	Qtr 3	Qtr 4	Qtr 1	Qtr 2	Qtr 3	Qtr 4
3387	1312500	Lessons learnt	◆	0d	Mon 10/10/16	Mon 10/10/16																												
3388	1313000	Synchronization Point [SP17 - Closing of migration]	◆	0d	Mon 10/10/16	Mon 10/10/16																												
3433	1309500	<b>TENTATIVE CONTINGENCY MIGRATION - MIGRATION WEEKEND</b>		4d	Fri 27/01/17	Mon 30/01/17																												
3434	1309600	Synchronization Point [SP16.5 - Ready for Contingency Migration Weekend]	◆	0d	Fri 27/01/17	Fri 27/01/17																												
3436	1309800	Contingency Wave Start Operations in T2S	◆	0d	Mon 30/01/17	Mon 30/01/17																												
3779	2000100	<b>PROGRAMME PLANNING &amp; MONITORING</b>		1932d	Thu 20/08/09	Fri 27/01/17																												
3848	2005100	<b>SYNCHRONISATION POINT</b>		1323d	Tue 20/12/11	Fri 27/01/17																												
3849	2006100	SP1 - Start Feasibility Confirmed	◆	0d	Tue 20/12/11	Tue 20/12/11																												
3850	2007100	SP2 - Feasibility Confirmation by CSD/CB	◆	0d	Fri 10/08/12	Fri 10/08/12																												
3851	2007200	SP3 - T2S Programme Plan Comprehensiveness	◆	0d	Mon 17/12/12	Mon 17/12/12																												
3852	2008100	SP4 - Network Service Provider Confirmed	◆	0d	Thu 24/04/14	Thu 24/04/14																												
3853	2009200	SP5 - Start of Eurosystem Acceptance Test	◆	0d	Wed 15/01/14	Wed 15/01/14																												
3854	2009100	SP6 - Eurosystem Ready for User Testing	◆	0d	Tue 02/09/14	Tue 02/09/14																												
3855	2010100	SP7 - Start Connectivity Testing	◆	0d	Mon 07/07/14	Mon 07/07/14																												
3856	2011100	SP8 - Start Bilateral Interoperability Testing	◆	0d	Wed 01/10/14	Wed 01/10/14																												
3857	2011200	SP9.1 - Start Multilateral Interoperability Testing (wave 1)	◆	0d	Mon 29/12/14	Mon 29/12/14																												
3858	2011300	SP9.2 - Start Multilateral Interoperability Testing (wave 2)	◆	0d	Thu 02/04/15	Thu 02/04/15																												
3859	2011400	SP9.3 - Start Multilateral Interoperability Testing (wave 3)	◆	0d	Tue 23/06/15	Tue 23/06/15																												
3860	2012100	SP10.1 - Start Community Testing (wave 1)	◆	0d	Wed 04/03/15	Wed 04/03/15																												
3861	2012200	SP10.2 - Start Community Testing (wave 2)	◆	0d	Fri 29/05/15	Fri 29/05/15																												
3862	2012300	SP10.3 - Start Community Testing (wave 3)	◆	0d	Mon 09/11/15	Mon 09/11/15																												
3863	2012400	SP11.1 - Start Business Day Testing (wave 1)	◆	0d	Mon 18/05/15	Mon 18/05/15																												
3864	2012500	SP11.2 - Start Business Day Testing (wave 2)	◆	0d	Mon 09/11/15	Mon 09/11/15																												
3865	2012600	SP11.3 - Start Business Day Testing (wave 3)	◆	0d	Wed 27/04/16	Wed 27/04/16																												
3866	2013100	SP12.1 - End of User Testing Execution Phase (wave 1)	◆	0d	Mon 15/06/15	Mon 15/06/15																												
3867	2013200	SP12.2 - End of User Testing Execution Phase (wave 2)	◆	0d	Mon 18/01/16	Mon 18/01/16																												
3868	2013300	SP12.3 - End of User Testing Execution Phase (wave 3)	◆	0d	Wed 29/06/16	Wed 29/06/16																												
3869	2014100	SP13 - Eurosystem ready for Production	◆	0d	Mon 01/12/14	Mon 01/12/14																												
3870	2015100	SP14.1 - Ready to connect to Production (wave 1)	◆	0d	Thu 05/02/15	Thu 05/02/15																												
3871	2015200	SP14.2 - Ready to connect to Production (wave 2)	◆	0d	Fri 02/10/15	Fri 02/10/15																												

Task    Task    Critical Milestone    Critical Task    Project Summary    Group By Summary

### T2S Detailed Plan with Critical Path

3/11/2020 11

ID	ID Number (Number 1)	Task Name	CSD/CB relevant activities	Duration	Start	Finish	Resource Group for PMG	2011				2012				2013				2014				2015				2016				2017								
								1st Half		2nd Half		1st Half		2nd Half		1st Half		2nd Half		1st Half		2nd Half		1st Half		2nd Half		1st Half		2nd Half		1st Half		2nd Half						
								Qtr.1	Qtr.2	Qtr.3	Qtr.4	Qtr.1	Qtr.2	Qtr.3	Qtr.4	Qtr.1	Qtr.2	Qtr.3	Qtr.4	Qtr.1	Qtr.2	Qtr.3	Qtr.4	Qtr.1	Qtr.2	Qtr.3	Qtr.4	Qtr.1	Qtr.2	Qtr.3	Qtr.4	Qtr.1	Qtr.2	Qtr.3	Qtr.4					
3872	2015300	SPI4.3 - Ready to connect to Production (wave 3)	◆	0d	Tue 22/03/16	Tue 22/03/16																																		
3873	2016100	SPI5.1 - Ready to upload Static Data (wave 1)	◆	0d	Thu 19/03/15	Thu 19/03/15																																		
3874	2016200	SPI5.2 - Ready to upload Static Data (wave 2)	◆	0d	Fri 06/11/15	Fri 06/11/15																																		
3875	2016300	SPI5.3 - Ready to upload Static Data (wave 3)	◆	0d	Fri 22/04/16	Fri 22/04/16																																		
3876	2017100	SPI6.1 - Ready for T2S Go-Live (wave 1)	◆	0d	Fri 19/06/15	Fri 19/06/15																																		
3877	2017200	SPI6.2 - Ready for Migration Wave 2	◆	0d	Fri 29/01/16	Fri 29/01/16																																		
3878	2017300	SPI6.3 - Ready for Migration Wave 3	◆	0d	Fri 15/07/16	Fri 15/07/16																																		
3879	2017400	SPI6.5 - Ready for Contingency Migration Weekend	◆	0d	Fri 27/01/17	Fri 27/01/17																																		
3880	2018300	SPI7 - Closing of migration	◆	0d	Mon 10/10/16	Mon 10/10/16																																		

# CURRENCY PARTICIPATION AGREEMENT

## SCHEDULE 2 – ANNEX 4

### T2S PROGRAMME PLAN ASSUMPTIONS

***Disclaimer:***

Planning is an ongoing process and Annexes with planning elements are subject to change during the lifetime of a project. Planning workshops with CSDs and CBs will continue to agree on the planning for Connectivity, User Testing and Migration. Subsequent plan updates follow the process, documented in the Schedule 2, Section 7.

Annexes 2, 3, 4, 7, 8, 9 and 10 document the planning status as at 8 Nov. 2011.

# Currency Participation Agreement

## Schedule 2 – Annex 4 – T2S Programme Plan Assumptions

---

### 1. Generic assumptions

For consultation, depending on the complexity and scope of changes, the review period should vary between *1 week and 2 months*.

### 2. From Specification Phase to Start of User Testing (UT)

*The preparation of the UDFS V1.2 and the BPD (Business Process Description) are vital for the end of the specification phase (SP1: synchronisation point) and for the start of the CSDs'/CBs' internal assessment.*

- Prior to the publication of UDFS V1.2 a review of UDFS V1.0 by the Market and 2 months of market consultation are planned.
- CSDs/CBs will have 8 months after the delivery of UDFS 1.2 to confirm their feasibility assessment.
- Between the completion of SP1 and the completion of SP2, 8 months are necessary.
- *After the delivery of UDFS V1.2* CSDs/CBs will have 24 months for adapting their internal systems.

*Registration for CSDs/CBs :*

- 1 month is required to fill in the Registration Guide

*Training Sessions:*

- the training sessions required for UT will start at least 12 months before UT
- the training sessions required for Migration rehearsal will start at least 6 months before each Migration rehearsal.

The Eurosystem will confirm the acceptance test for the VAN at the latest 9 months prior to the start of UT.

The CB/CSDs should finalise the negotiations with the NSP at least 3 months prior the start of the connectivity tests.

The *Dedicated lines Connectivity specifications* are delivered at least 1 year before starting the UT.

# Currency Participation Agreement

## Schedule 2 – Annex 4 – T2S Programme Plan Assumptions

---

33 *The first delivery of the Manual of Operational Procedure (MOP) will be ready 6 months before*  
34 *the start of UT. A revised version of the MOP will be delivered 1 month before each go-live.*

35

36 *Pilot testing:*

- 37 - A pilot testing might be offered only to the CSDs participating to the UT Wave 1.
- 38 - Takes place in parallel of the EAT and before the UT starts.
- 39 - This pilot testing is lasting 3 months

### 40 **3. UT**

41 *The UT is split into the following stages:*

- 42 - Bilateral stages:
  - 43 o Connectivity
  - 44 o Interoperability (IO) Bilateral
  - 45 o CSD/CB Acceptance
  - 46 o CSD/CB Certification
- 47 - Multilateral stages:
  - 48 o IO Multilateral
  - 49 o Community
  - 50 o Business Day

51 *The Eurosystem Acceptance Test Assessment Report is an entry criteria for the UT.*

52 *Before starting the UT, the Eurosystem will provide enough assurance as regard the capacity of*  
53 *the T2S application/infrastructure to meet the non-functional requirements.*

#### 54 **3.1 UT Waves**

55 *The T2S Programme Plan is based on the assumption that the UT and migration will be done by*  
56 *migration waves. There is a maximum of four migration waves (and contingency wave) spread*  
57 *over a maximum of 18 months (from go-live wave 1 to go-live contingency).*

58 *The assumptions for UT duration are as follow:*

- 59 - Wave 1: 12 months (including pilot testing).
- 60 - Wave 2: 18 months
- 61 - Wave 3 and subsequent waves: at least 18 months.

62 *All CSDs and CBs having links with the CSDs and CBs migrating must participate in IO*  
63 *Multilateral, Community and Business Day.*

64 *CSD/CB can start UT when they want, planning enough time to complete all their testing within*  
65 *the defined time line.*

# Currency Participation Agreement

## Schedule 2 – Annex 4 – T2S Programme Plan Assumptions

---

### 66 **3.2 Connectivity**

67 *Connectivity Testing VAN*: the T2S Programme Plan assumes 1 month for connectivity and is a  
68 predecessor of the UT (IO Phase).

69 *Connectivity Testing for Dedicated lines*: further information will be provided in the future.

### 70 **3.3 IO**

71 *IO testing is divided in two*: IO Bilateral and IO Multilateral.

72 *IO environment remains available* for IO Bilateral and Multilateral during the Community and  
73 Business Day testing.

### 74 **3.4 Migration Test**

75 Migration Test runs in parallel with IO, Community Testing and Business Day.

### 76 **3.5 CSD/CB Certification**

77 CSD/CB Certification runs in parallel of the IO Bilateral.

78 A CSD/CB has to be certified to participate to the IO Multilateral.

### 79 **3.6 CSD Acceptance**

80 CSD Acceptance starts together with the bilateral IO for all waves (SP8 – Start bilateral IO).

81 CSD Acceptance lasts up to 6 months.

### 82 **3.7 Community**

#### 83 **3.7.1 DCP/DCAH Certification**

84 DCP/DCAH Certification runs in parallel of the Community Testing.

### 85 **3.8 Business Day**

86 Business Day Test: the following assumptions are taken for the duration:

- 87 - Wave 1: 3 weeks
- 88 - Wave 2 and subsequent waves: at least 1 months

### 89 **3.9 Transition phase between stages:**

90 *From bilateral to multilateral stages*, two weeks are planned in parallel of the bilateral stage.

91 *From multilateral to community stages*, 4 weeks are planned. 3 weeks run in parallel of the  
92 multilateral stage and 1 week between multilateral and community stages.

93 The *IO exit criteria and Community entry criteria* have to be met within:

- 94 - Wave 1: 3 months

# Currency Participation Agreement

## Schedule 2 – Annex 4 – T2S Programme Plan Assumptions

---

- 95 - Wave 2 and subsequent waves: at least 6 months
- 96 *From community to business day stages, 4 weeks are planned. 3 weeks run in parallel of the*
- 97 *community stage and 1 week between community and business day stages.*
- 98 *The Community exit criteria and BD entry criteria have to be met within:*
- 99 - Wave 1: 4.5 months
- 100 - Wave 2 and subsequent waves: at least 5 months
- 101 *At the end of business day stage, 3 weeks are planned. 2 weeks run in parallel of the business day*
- 102 *stage and 1 week during the freeze period.*

### 103 **3.10 Other Assumptions for UT**

- 104 *There is a freeze period of two weeks between the end of the UT and the Migration WE of each*
- 105 *wave.*

## 106 **4. Pre-Migration and Migration**

- 107 *All CSDs and CBs belonging to the same wave migrate at the same time.*
- 108 *Connectivity to production environment: T2S Programme Plan foresees 2 weeks of production*
- 109 *connectivity testing.*
- 110 *Production Environment: will be available for Users 3 months before the go-live of wave 1.*
- 111 *CSD/CB Static Data Cleansing according to the T2S migration rules: 1 month planned before*
- 112 *Load Static Data.*
- 113 *Load Static Data: 3 months planned before the go-live in parallel to UT.*
- 114 *There is a minimum of 3 months between two migration waves (Schedule 4).*
- 115 *Migration cannot happen during critical times (e.g. end of the year)*
- 116





## **CURRENCY PARTICIPATION AGREEMENT**

### **SCHEDULE 2 - ANNEX 5**

## **T2S PROGRAMME PROGRESS REPORTING TEMPLATES**

# Currency Participation Agreement

## Schedule 2 - Annex 5 – T2S Programme Progress Reporting Templates

### 1 1 Template for reporting at T2S programme Work Stream and Sub-Stream Level:

- 2 Reports change in status compared to previous reporting period for status  
 Summarises the overall assessment of the quality, time and scope dimensions for the work sub-stream.
- Expected trend for next reporting period
- Highlights whether critical risks exist
- Reports change in risk situation compared to previous reporting period

PROGRAMME WORKSTREAM	STATUS	CHANGE	TREND	RISK	CHANGE
<b>Programme WBS item 1</b>	R	→	↗	R	→
Sub Stream monitoring element 1 Financial Framework	Y	→	↗	Y	→
<b>Programme WBS item 2</b>	G	→	→	G	→
Sub Stream monitoring element 3 Sub Stream monitoring element n	R	→	→	R	→
<b>PRODUCT READINESS</b>	R	→	→	R	→
Specification and Documentation Sub Stream monitoring element n	N/A	→	→	N/A	→
Eurosystem Acceptance Test User Test Start	G	→	→	R	→
Sub Stream monitoring element n	G	→	→	G	→
Sub Stream monitoring element n	Y	→	→	G	→
<b>Programme WBS item x</b>	G	→	→	G	→
Sub Stream monitoring element n Migration	G	→	→	G	→
Sub Stream monitoring element n	Y	→	↗	Y	→

T2S Programme Work

T2S Work Sub-Stream

## Currency Participation Agreement

### Schedule 2 - Annex 5 – T2S Programme Progress Reporting Templates

#### 2 Template for reporting the T2S Detailed Status:

4 T2S Detailed Status for reporting:

5

DELIVERABLE / MILESTONE	DATE	STATUS	CHANGE	TREND	RISKS	CHANGE
[Placeholder for name of deliverable/milestone] [Placeholder for relevant milestone of a deliverable, if applicable]	[Date]	R	↑	↑	G	↑
Status Update						
<ul style="list-style-type: none"><li>▪ [Lists milestones achieved for reporting period]</li><li>▪ [Lists missed milestones or deadlines for previous reporting period]</li><li>▪ [if applicable] List of mitigating actions<ul style="list-style-type: none"><li>– [Placeholder for explanation]</li></ul></li></ul>						

## Currency Participation Agreement

### Schedule 2 - Annex 5 – T2S Programme Progress Reporting Templates

---

6 **3 Status Assessment at T2S Programme Work Stream and Sub-Stream**  
7 **Level:**

8 The responsible for each ECB workstream makes his/her assessment according to the conventions defined  
9 above.

10 At aggregated level (Dashboard) the business rule is: if the progress assessment is not uniformly Green for  
11 all deliverables/activities belonging to a specific stream or sub-stream, at least a Yellow status is reported at  
12 aggregated level.

13 The detailed information by deliverable or activity is then provided at the Detailed status report level.

14

15 **4 Status Assessment at CSD/CB level:**

16

17 Each CSD/CB makes its assessment. This is discussed with the Relationship Manager during the MCR  
18 sessions (see T2S Monitoring of Client Readiness Framework, Annex 5).

19 The various assessments are collected and discussed internally within the Client Readiness Workstream.

20 Based on the discussion outcomes, the Relationship Manager assesses the overall CSD/CB readiness for the  
21 respective activity or milestone, following these business rules:

- 22 • In case the assessment is not Green for all CSDs or CBs, the “Green” status is not allocated, i.e. at  
23 least Yellow.
- 24 • Confidentiality rules applies (see Monitoring of Client Readiness Framework, Annex 5) to explain  
25 the overall status if different from Green.

26 Once discussed, the assessment is reflected in the global progress status dashboard and a detailed status is  
27 prepared for all deliverables having a status “Yellow” or “Red”.



# **CURRENCY PARTICIPATION AGREEMENT**

## **SCHEDULE 2 - ANNEX 6**

### **T2S RISK AND ISSUE REPORTING TEMPLATE**

# Currency Participation Agreement

## Schedule 2 - Annex 6 – T2S Risk and Issue Reporting Template

---

### 1 **1 Risk and Issue Reporting**

2 Parties to this agreement who have identified and assessed a programme risk or an issue  
3 originating/occurring in their own institution provide the T2S Programme Office with a filled-in  
4 risk/issue identification form. The form shall provide at least the following information:

5 Risk identification form:

- 6 ▪ Work stream / Sub-Work stream / Deliverable / Milestone / Synchronisation Point
- 7 ▪ Risk name
- 8 ▪ Risk description (background)
- 9 ▪ Reported by
- 10 ▪ Status (raised / mitigation in process / mitigated / accepted)
- 11 ▪ Probability (level 1-5)
- 12 ▪ Impact (level 1–5)
- 13 ▪ Criticality (colour)
- 14 ▪ Risk Response
- 15 ▪ Root cause category (product & services/external/internal)

16 Issue identification form:

- 17 ▪ Work stream / Sub-Work stream / Deliverable / Milestone / Synchronisation Point
- 18 ▪ Issue name
- 19 ▪ Issue description (background)
- 20 ▪ Reported by
- 21 ▪ Resolution strategy
- 22 ▪ Target Date for resolution

23 The T2S Programme Office includes the information received from risk/issue owners in the  
24 forthcoming risk report to be submitted to the T2S Board. For a detailed process description for  
25 the reporting and sharing of identified risks/issues, see Annex 2.

26

# Currency Participation Agreement

## Schedule 2 - Annex 6 – T2S Risk and Issue Reporting Template

27 Based on the information received from contractual parties, the T2S Programme Office will  
 28 prepare its regular assessment reports. To that end, it may use the following (sample) templates  
 29 for the reporting of risks and issues:

30 Risk Reporting:

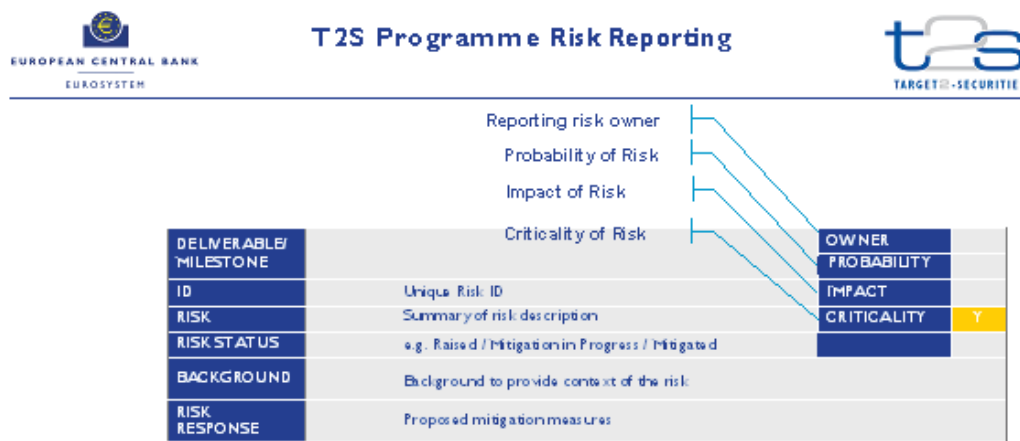

The diagram shows the 'T2S Programme Risk Reporting' template. It features the logos of the European Central Bank (Eurosystem) and Target2-Securities. The template is a table with the following structure:

DELIVERABLE/ MILESTONE		OWNER	PROBABILITY	IMPACT	CRITICALITY
ID	Unique Risk ID				
RISK	Summary of risk description				
RISK STATUS	e.g. Raised / Mitigation in Progress / Mitigated				Y
BACKGROUND	Background to provide context of the risk				
RISK RESPONSE	Proposed mitigation measures				

Annotations with lines pointing to the table:

- Reporting risk owner (points to OWNER)
- Probability of Risk (points to PROBABILITY)
- Impact of Risk (points to IMPACT)
- Criticality of Risk (points to CRITICALITY)

31

32 Issue Reporting:

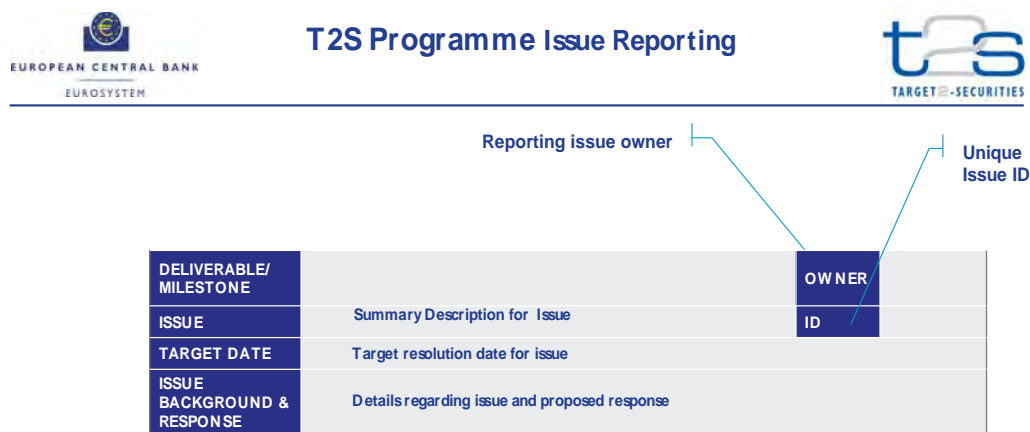

The diagram shows the 'T2S Programme Issue Reporting' template. It features the logos of the European Central Bank (Eurosystem) and Target2-Securities. The template is a table with the following structure:

DELIVERABLE/ MILESTONE		OWNER
ISSUE	Summary Description for Issue	ID
TARGET DATE	Target resolution date for issue	
ISSUE BACKGROUND & RESPONSE	Details regarding issue and proposed response	

Annotations with lines pointing to the table:

- Reporting issue owner (points to OWNER)
- Unique Issue ID (points to ID)

33

## **CURRENCY PARTICIPATION AGREEMENT**

### **SCHEDULE 2 – ANNEX 7**

#### **T2S PROGRAMME WORK BREAKDOWN STRUCTURE**

***Disclaimer:***

Planning is an ongoing process and Annexes with planning elements are subject to change during the lifetime of a project. Planning workshops with CSDs and CBs will continue to agree on the planning for Connectivity, User Testing and Migration. Subsequent plan updates follow the process, documented in the Schedule 2, Section 7.

Annexes 2, 3, 4, 7, 8, 9 and 10 document the planning status as at 7 Nov. 2011.



# Currency Participation Agreement

## Schedule 2 – Annex 7 – T2S Programme Work Breakdown Structure

---

<b>Programme Workstream</b>	<b>Deliverable Stream</b>	<b>Deliverable Substream</b>
<b>Client Readiness</b>	Contractual Framework	Framework Agreement Currency Participation Agreement
	User Training and Testing	Training Preparation Training Execution User Testing Preparation User Testing Execution
	Synchronization and on-boarding	CSD Readiness CB Readiness Eurosystem Readiness*
	Relationship Management*	CSDs* CBs* DCPs* Market Report*
	Other Documentation*	
<b>Product Readiness</b>	Specification and Documentation	Requirements Specifications Documentation
	Development	Software & 4CB Testing Infrastructure
	Eurosystem Acceptance Test	EAT Preparation EAT Execution
<b>Operational Readiness</b>	Operations	Operational Procedures Service Level Agreement
	Migration	Migration Preparation Pre-Migration Tasks (per waves) Migration WE (per waves)
	Network and connectivity Information Security	
<b>Policy and Marketing</b>	Policy Framework and Governance	Harmonisation Other policy frameworks* Governance*
	Marketing and Communication* Financials*	Liability* Financials planning and procedures*
	Relationship Management*	Regulators* Public authorities* Other External stakeholders*
<b>Legal*</b>	Legal Framework*	L2/L3 Agreement* Other Legal Acts*
<b>Programme Planning and Monitoring</b>		

\* Elements provided only for information, as they cover Eurosystem internal work.

## **CURRENCY PARTICIPATION AGREEMENT**

### **SCHEDULE 2 – ANNEX 8**

#### **T2S DELIVERABLES LIST AND MANAGEMENT PROCESS**

***Disclaimer:***

Planning is an ongoing process and Annexes with planning elements are subject to change during the lifetime of a project. Planning workshops with CSDs and CBs will continue to agree on the planning for Connectivity, User Testing and Migration. Subsequent plan updates follow the process, documented in the Schedule 2, Section 7.

Annexes 2, 3, 4, 7, 8, 9 and 10 document the planning status as at 7 Nov. 2011.

# Currency Participation Agreement

## Schedule 2 – Annex 8 – T2S Deliverables list and management process

### 1. Document Scope and Objective

The objective of this document is to provide a baseline catalogue of T2S deliverables that are of interest for CSDs and CBs and that describes the scope of and the respective responsibilities for each deliverable. This catalogue defines a deliverable only once, even though the programme requires several versions of a deliverable, such as regular updates or a dedicated version of a deliverable specific to a migration wave.

The deliverable monitoring is part of the Monitoring Framework process as defined in the main document of the Schedule 2.

### 2. T2S Deliverables

#### 2.1 Deliverable Specification

This annex provides a standardised definition of each T2S deliverable. The standardised definition documents not only a deliverable's purpose and scope, but also additional characteristics relating to responsibilities and Change Management.

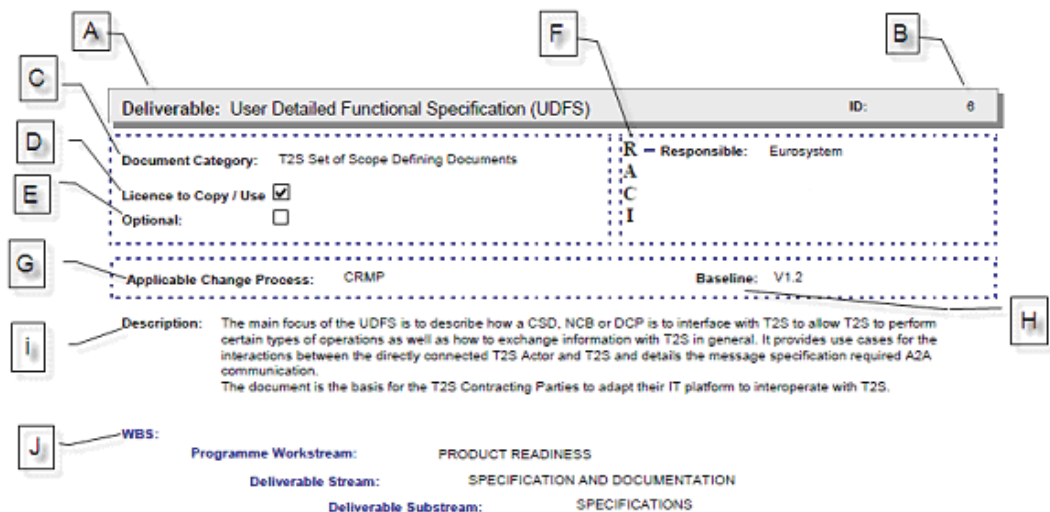

# Currency Participation Agreement

## Schedule 2 – Annex 8 – T2S Deliverables list and management process

Label	Attribute Name	Description
A	Deliverable	This attribute documents the name of the deliverable.
B	ID	This attribute specifies the unique identifier of the deliverable. The Operational Plan and the Synchronisation Point (if relevant) use the identifier to reference the underlying deliverable.
C	Document Category	This attribute specifies the category of document to which the deliverable belongs (see below table in this annex).
D	License to Copy/Use	Each deliverable has an attribute that states who owns the Intellectual Property Rights and whether a licence to copy or use exists for the other parties as set out in the FA (article 28) and CPA (article 31).
E	Optional	This attribute specifies whether this deliverable is optional or mandatory. <u>Value</u> <u>Description</u> Ticked   Optional Empty   Mandatory
F	RACI	The attribute defines the responsibilities and accountabilities for a deliverable.
G	Applicable Change Management Process	This attribute specifies which Change Management process applies to the deliverable, e.g. <u>Value</u> <u>Description</u> CRMP   Change and Release Management Process according to Schedule 9 of this agreement. ...
H	Baseline	The attribute specifies the version of the deliverable from which the Change Management process specified by the attribute “Applicable Change Management Process” applies.
i	Description	The attribute provides a short description of the scope and content of the deliverable.
J	Work Breakdown Structure (WBS)	This attribute specifies the classification in the WBS of the T2S Programme Plan under which the deliverable is managed and reported.

## 2.2 Responsible, Accountable, Consulted, Informed (RACI)

### 2.2.1 Responsible

This classifier assigns to a deliverable *those who do the actual work* by specifying the Party, i.e. Eurosystem, CSD or CB, responsible for creating and maintaining the deliverable throughout its life cycle.

### 2.2.2 Accountable

This classifier assigns to a deliverable *those who are ultimately accountable for the completion of the work*. The body that is accountable is the approving body. The FA-CPA Agreement defines the body

## Currency Participation Agreement

### Schedule 2 – Annex 8 – T2S Deliverables list and management process

---

that is accountable for the legal documents and the T2S Scope Defining Set of Documents. Schedule 8 of this Agreement defines in its section “Decision-making on relevant matters other than Change Requests” the body that is accountable for all other deliverables.

For the purpose of the Annex 8, Deliverable List, the body mentioned will be the sub-structure that writes a recommendation to approve to the Steering Level.

#### **2.2.3 Consulted**

This classifier assigns to a deliverable *those who provide input* as needed by specifying whether or not the Party to the Agreement is consulted regarding the T2S deliverable. The T2S Programme Plan specifies the frequency and the duration of the consultation for the deliverable. Consulted can mean written procedures or workshops. In case Change Request affects a deliverable, then the consultation also applies for subsequent updated versions.

Consulted refers to a formal process where the Responsible expects comments from other Parties to the Agreement (in particular CSDs and CBs). This means that the Responsible submits a DRAFT version and collects the comments. The Responsible analyses all comments and must:

- (a) consider the comments and/or produce a new version; or
- (b) explain why a comment has not been taken on board.

#### **2.2.4 Informed**

This classifier assigns to a deliverable *those who need to be kept up to date* on progress of the particular phase. The Responsible submits a proposal as regard the distribution list (bodies to be informed) to the Accountable body together with the draft document. Being informed might take the form of an early involvement.

#### **2.3 Baseline**

The Responsible produces the draft version that upon approval as described in the Section 3 becomes a ‘Baseline’ (with or without consultation of the other Party). A ‘Baseline’ serves as basis/reference for the Party to undertake a series of actions required for the T2S Programme completion. Each deliverable has an attribute that specifies the version number that will be considered as ‘Baseline’. This version number also appears in the Plan. Any change to the baseline follows a formal change process, as defined thereafter. The latest baseline version available for this release of T2S must be easily identifiable.

## **Currency Participation Agreement**

### **Schedule 2 – Annex 8 – T2S Deliverables list and management process**

---

Outside of the Legal Acts, the initial baseline number is indicated in the T2S List of deliverables.

#### **2.4 Applicable Process per Document Type**

Each deliverable has an attribute that specifies the applicable process for approving the baseline or the changes to it – which is summarised in the table below. Some deliverables are not subject to any formal Change Management process. The deliverables subject to a Change Management process are communicated either in a complete version (with revision marks if technically possible or with indication of a list of changes) or in an intermediate document (e.g. Document Change Notice) to avoid waiting for the next release of the deliverable. The modalities for communication are defined, on a case-by-case basis, in the course of the Change Management process.

## Currency Participation Agreement

### Schedule 2 – Annex 8 – T2S Deliverables list and management process

Document Category	Description <sup>1</sup>	Initial Baseline number is indicated in	Substructure involved	Change Management Process	
<b>Legal Acts</b>	Means the FA / CPA and their respective schedules.	N/A	N/A	Specific FA / CPA Process	
<b>T2S Scope Defining Set of Documents</b>	Means the set of documents defining the scope of T2S composed of the URD, the UDFS, the GUI Business Functionality, GFS Functional Chapter and the Dedicated Link Connectivity Specifications.	The deliverables list	CRG	Change Request (Schedule 9)	
<b>T2S Documentation</b>	<b>T2S Specification</b>	Means the set of documents, when added to the T2S Scope Defining Set of Documents, provide a full description of T2S. This includes the GFS non-Functional Chapter.	The deliverables list	CRG	Deliverable Change Process (Schedule 2) Unless otherwise specified in the list of deliverables
	<b>T2S Operational Phase Documents</b>	Means the set of documents that describes how T2S provides its services when it is in production. It encompasses the documentation for T2S as a software application and the manuals describing the rules and procedures for operating T2S.	The deliverables list	OMG	Deliverable Change Process (Schedule 2) Unless otherwise specified in the list of deliverables
	<b>T2S Project Documents</b>	Means the set of documents required for planning, monitoring and successfully completing the scheduled activities (e.g. User Testing, Migration, client readiness tracking) in the T2S project lifecycle but not during the operational part, i.e. from the start of the T2S Programme until T2S is live, or during any subsequent preparation for releases.	The deliverables list	PMG	Deliverable Change Process (Schedule 2) Unless otherwise specified in the list of deliverables

<sup>1</sup>. As included in Schedule 1.

# Currency Participation Agreement

## Schedule 2 – Annex 8 – T2S Deliverables list and management process

### 3. Deliverable Approval and Change Process

This section describes the approval and change process for deliverables which are neither subject to the FA/CPA Change Management process nor to the CRMP (Schedule 9).

#### 3.1 High-Level Deliverable Approval Process – Creation of a Baseline

The following process applies for the approval of the first Baseline for each Deliverable:

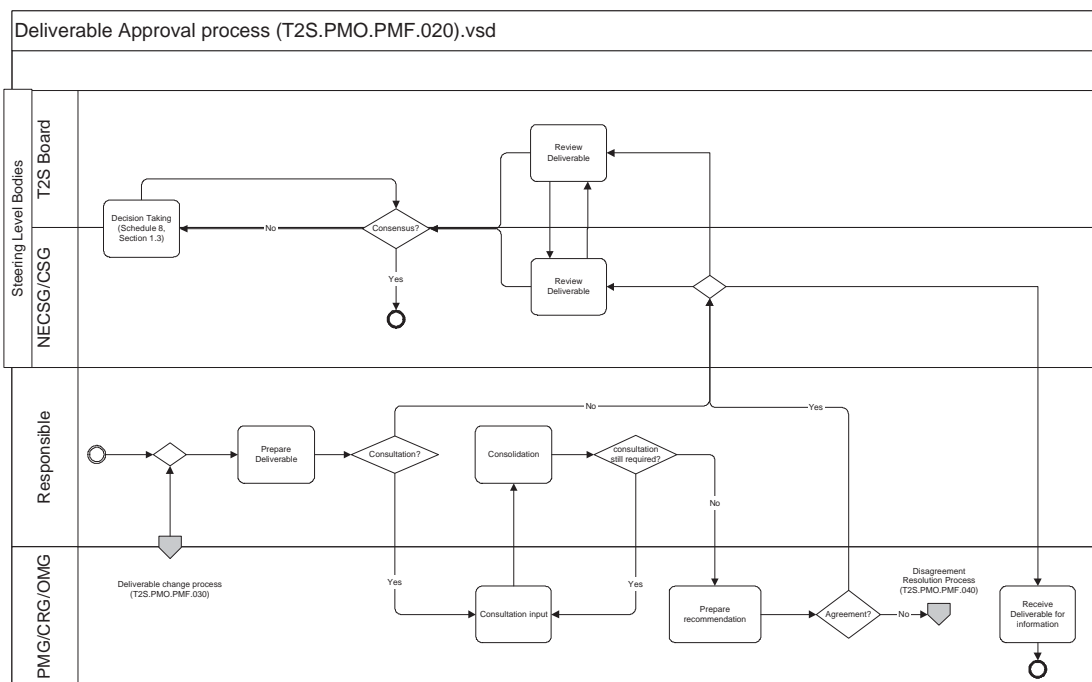

#### 3.1.1 Process Actors and their Roles

Process Actor	Process Role
Responsible	As above defined.
PMG/CRG/OMG <i>(one body only, depending on the deliverable category)</i>	In this process, the Responsible consults the PMG/ORG/OMG. It is the responsibility of the consulted body to provide comments during the approval process and to proactively and in good faith try achieving agreement among its members.
CSG/NECSG	The CSG/NECSG is responsible for reviewing the Deliverable, taking into account the recommendations supplied by the PMG and taking all necessary steps to reach a consensus at Steering Level.



## Currency Participation Agreement

### Schedule 2 – Annex 8 – T2S Deliverables list and management process

---

---

T2S Board	The T2S Board is responsible for endorsing the Deliverable, taking into account the recommendations supplied by the PMG and taking all necessary steps to reach a consensus at Steering Level. The T2S Board also coordinates the work at Steering Level to reach a consensus following the process described in Schedule 8, Section 1.3.
-----------	---

---

#### **3.1.2 High-Level Process Description**

This section provides an overview of the process for Baseline creation for deliverables.

The Responsible after drafting the deliverable and if applicable, sends the deliverable for consultation of other parties.

During consultation, in case of diverging views the PMG/CRG/OMG members have the opportunity to inform the NECSG/CSG about their diverging views (in line with the section 7.4 Disagreement Resolution process in Schedule 2).

After consultation and in line with RACI information, the Responsible presents the deliverable for approval to the Steering Level. If consulted, the PMG/CRG/OMG writes a recommendation to approve. This recommendation is attached to the Deliverable submission to the Steering Level.

The Steering Level endorses the deliverable by consensus. The T2S Board coordinates the work at Steering Level to reach a consensus following the process described in Schedule 8, Section 1.3.

# Currency Participation Agreement

## Schedule 2 – Annex 8 – T2S Deliverables list and management process

### 3.2 Deliverable Change Process – Updating a Baseline

Each deliverable has a specific Change Management process. This process is described either in the Schedule 9 – Change Request– or in this section. The below process applies to all deliverables for which the ‘Applicable Process’ clearly foresees ‘*Deliverable Change Process*’ as opposed to other value (e.g. Change Request).

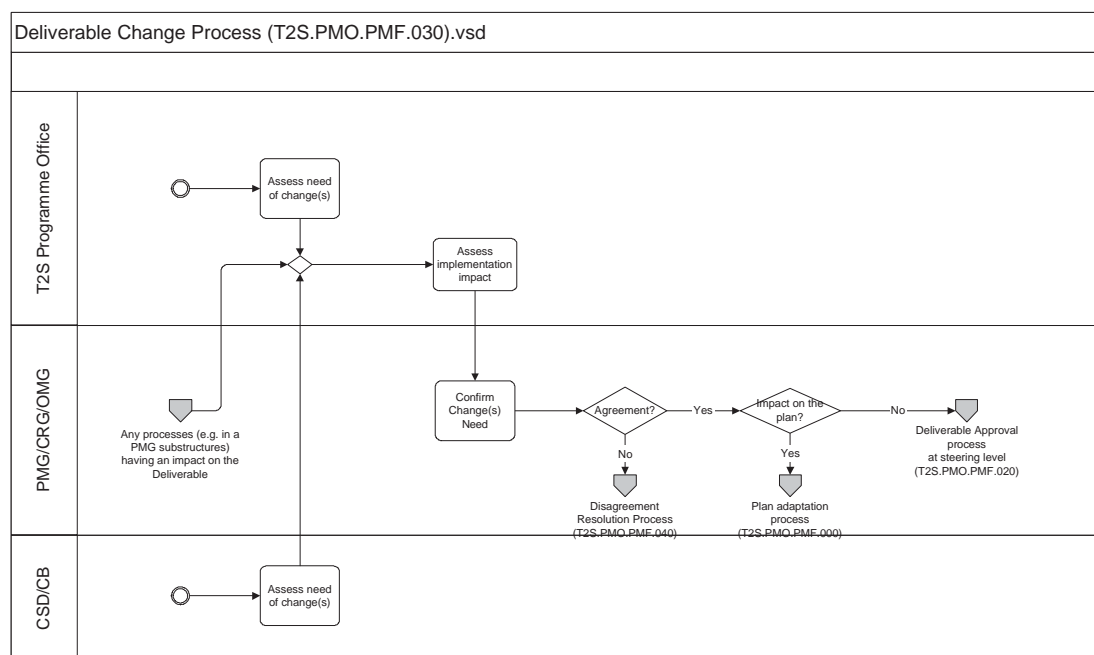

#### 3.2.1 Process Actors and their Roles

Process Actor	Process Role
T2S Programme Office	<p>The T2S Programme Office is in charge of:</p> <ul style="list-style-type: none"> <li>identifying, collecting and raising Change Requests (e.g. need to update due to another deliverable);</li> <li>undertaking the assessment of changes request;</li> <li>communicating the results of the assessment to the PMG/CRG/OMG; and</li> <li>implementing the change when the Eurosystem is the Responsible.</li> </ul>
CSD, CBs	<p>The CSDs and/or CBs are in charge of:</p> <ul style="list-style-type: none"> <li>implementing the change when CSDs and/or CBs are the Responsible; and</li> <li>identifying and raising Change Requests, if relevant.</li> </ul>
PMG/CRG/OMG <i>(one body only, depending on the Deliverable)</i>	<p>In this process, the PMG/CRG/OMG is in charge of:</p> <ul style="list-style-type: none"> <li>reviewing and discussing the Change Requests;</li> <li>confirming the need of the change or rejecting the request; and</li> <li>in case of disagreement, escalation to the NECSG/CSG or T2S Board (in line with the section 7.4 Disagreement Resolution process in Schedule 2).</li> </ul>

## **Currency Participation Agreement**

### **Schedule 2 – Annex 8 – T2S Deliverables list and management process**

---

#### **3.2.2 High Level Process Description**

This section provides an overview of the process for Baseline update for deliverables.

The T2S Programme Office and/or CSDs and/or CBs may wish to change a deliverable.

T2S Programme Office collects the change(s) request. Thereafter, the T2S Programme Office assesses the change(s) request (including Plan impact assessment). The PMG/CRG/OMG reviews the change(s) request together with the T2S Programme Office assessment.

After agreement on the change(s) at PMG/CRG/OMG level, the approval process at Steering Level should follow the initial approval process used to create the baseline (see section 3.1).

In case of disagreement, the PMG/CRG/OMG may initiate the disagreement resolution process to get agreement on the proposed change(s) (in line with the section 7.4 Disagreement Resolution process in Schedule 2).

# Currency Participation Agreement

## SCHEDULE 2 – ANNEX 8 – T2S list of Deliverables

<b>Deliverable:</b> Graphical User Interface (GUI) Business Functionalities	<b>ID:</b> 3
---	--------------

<b>Document Category:</b> T2S Scope Defining Set of Documents <b>Licence to Copy / Use</b> <input checked="" type="checkbox"/> <b>Optional:</b> <input type="checkbox"/>	<b>R – Responsible:</b> Eurosystem <b>A – Accountable:</b> CRG <b>C – Consultation:</b> CSD, CB <b>I – Information:</b>
<b>Applicable Change Process:</b> CRMP	<b>Baseline:</b> V1.0

**Description:** The scope of this document is to provide a list of business functions- expected for the T2S Graphical User Interface and to provide a brief description covering the purpose and key features of the business functions. It also depicts the framework for logical association of business functions applicable for a business object. (The framework diagrams in this document do not depict certain access features that are purely of technical nature like returning to the previous or exit from a function).

**WBS:**  
**Programme Workstream:** PRODUCT READINESS  
**Deliverable Stream:** SPECIFICATION AND DOCUMENTATION  
**Deliverable Substream:** SPECIFICATIONS

<b>Deliverable:</b> User Detailed Functional Specification (UDFS)	<b>ID:</b> 6
---	--------------

<b>Document Category:</b> T2S Scope Defining Set of Documents <b>Licence to Copy / Use</b> <input checked="" type="checkbox"/> <b>Optional:</b> <input type="checkbox"/>	<b>R – Responsible:</b> Eurosystem <b>A – Accountable:</b> CRG <b>C – Consultation:</b> CSD, CB <b>I – Information:</b>
<b>Applicable Change Process:</b> CRMP	<b>Baseline:</b> V1.2

**Description:** This deliverable is the manual that describes how a T2S Actor can interface ist software applications with T2S to enable T2S to execute certain types of operations and to exchange information with T2S. It provides use cases for the interactions between the Directly Connected T2S Actor and T2S and details the message specification required A2A communication. The UDFS also contains the specifications required in order to set-up and manage the direct connectivity with T2S. The document is the basis for the T2S Contracting Parties to adapt their IT platform to interoperate with T2S.

**WBS:**  
**Programme Workstream:** PRODUCT READINESS  
**Deliverable Stream:** SPECIFICATION AND DOCUMENTATION  
**Deliverable Substream:** SPECIFICATIONS

# Currency Participation Agreement

## SCHEDULE 2 – ANNEX 8 – T2S list of Deliverables

**Deliverable:** T2S Dedicated Link Connectivity Specifications

**ID:** 7

**Document Category:** T2S Specifications

**Licence to Copy / Use**

**Optional:**

**R – Responsible:** Eurosystem

**A – Accountable:** Eurosystem

**C – Consultation:**

**I – Information:** CSD, CB

**Applicable Change Process:** CRMP

**Baseline:** V1.0

**Description:** This documents provides the CSD, DCP, CB and DCAHs with the detailed specifications to be respected in order to set-up a direct connectivity line between CSDs, CBs, DCPS and T2S.

**WBS:**

**Programme Workstream:** OPERATIONAL READINESS

**Deliverable Stream:** NETWORK AND CONNECTIVITY

**Deliverable Substream:** NETWORK AND CONNECTIVITY

**Deliverable:** T2S Connectivity Guide

**ID:** 8

**Document Category:** T2S Project Documents

**Licence to Copy / Use**

**Optional:**

**R – Responsible:** Eurosystem

**A – Accountable:** Eurosystem

**C – Consultation:**

**I – Information:** CSD, CB

**Applicable Change Process:** Deliverable Change Process (PMG)

**Baseline:** V1.0

**Description:** The connectivity guide documents the steps required for T2S Actors to connect to T2S test and production environments. The document will present the technical landscape (tools and network provider selection) used to facilitate the understanding, and will also present the protocols supported. A checklist will summarize the requirements to connect.

The document will cover both A2A and U2A aspects it also covers both VANs and Direct Connectivity. The information provided may vary depending on the provider.

**WBS:**

**Programme Workstream:** OPERATIONAL READINESS

**Deliverable Stream:** NETWORK AND CONNECTIVITY

**Deliverable Substream:** NETWORK AND CONNECTIVITY

# Currency Participation Agreement

## SCHEDULE 2 – ANNEX 8 – T2S list of Deliverables

**Deliverable:** User Hand Book (UHB)

**ID:** 9

**Document Category:** T2S Specifications

**Licence to Copy / Use**

**Optional:**

**R – Responsible:** Eurosystem

**A – Accountable:** CRG

**C – Consultation:**

**I – Information:** CSD, CB

**Applicable Change Process:** Deliverable Change Process (CRG)

**Baseline:** V2.0

**Description:** The UHB describes the Graphical User Interface (GUI) of T2S, i.e. U2A communication. It is intended for the business user, who will interact with T2S for updating and querying data. It presents information on the application behaviour, window navigation, windows, fields and validation rules in order to explain how a user can perform specific operations in T2S through the GUI.

### WBS:

**Programme Workstream:** PRODUCT READINESS

**Deliverable Stream:** SPECIFICATION AND DOCUMENTATION

**Deliverable Substream:** DOCUMENTATION

**Deliverable:** Manual of Operational Procedures (MOP)

**ID:** 10

**Document Category:** T2S Operational Phase Documents

**Licence to Copy / Use**

**Optional:**

**R – Responsible:** Eurosystem

**A – Accountable:** OMG

**C – Consultation:** CSD, CB

**I – Information:**

**Applicable Change Process:** Deliverable Change Process (OMG)

**Baseline:** V1.0

**Description:** This manual provides the detailed procedures to be followed by the T2S Actors and the Eurosystem to ensure the smooth functioning of T2S for normal operations as well as in contingency and exceptional situations (e.g. Disaster Recovery and Business Continuity).

### WBS:

**Programme Workstream:** OPERATIONAL READINESS

**Deliverable Stream:** OPERATIONS

**Deliverable Substream:** OPERATIONAL PROCEDURES

# Currency Participation Agreement

## SCHEDULE 2 – ANNEX 8 – T2S list of Deliverables

**Deliverable:** Information Security Policy

**ID:** 12

**Document Category:** Legal Acts

**Licence to Copy / Use**

**Optional:**

**R – Responsible:** Eurosystem

**A – Accountable:** Eurosystem

**C – Consultation:** CSD, CB

**I – Information:**

**Applicable Change Process:** N/A

**Baseline:** FA/CPA

**Description:** The Information Security Policy for T2S is a high-level document that defines the principle and scope of, allocation of responsibilities for and other relevant aspects of information security for T2S.

### WBS:

**Programme Workstream:** CLIENT READINESS

**Deliverable Stream:** CONTRACTUAL FRAMEWORK

**Deliverable Substream:** FRAMEWORK AGREEMENT

**Deliverable:** User Testing Strategy

**ID:** 17

**Document Category:** T2S Project Documents

**Licence to Copy / Use**

**Optional:**

**R – Responsible:** Eurosystem

**A – Accountable:** PMG

**C – Consultation:** CSD, CB

**I – Information:**

**Applicable Change Process:** Final

**Baseline:** V1.0

**Description:** This strategy document presents the high-level planning, stages and roles of the various T2S Actors in the User Testing phase of T2S. It serves as guideline for Schedule 3 of the Framework Agreement and Currency Participation Agreement on User Testing.

### WBS:

**Programme Workstream:** CLIENT READINESS

**Deliverable Stream:** USER TRAINING AND TESTING

**Deliverable Substream:** USER TESTING PREPARATION

# Currency Participation Agreement

## SCHEDULE 2 – ANNEX 8 – T2S list of Deliverables

**Deliverable:** User Testing Guide

**ID:** 18

**Document Category:** T2S Project Documents

**Licence to Copy / Use**

**Optional:**

**R – Responsible:** Eurosystem

**A – Accountable:** PMG

**C – Consultation:** CSD, CB

**I – Information:**

**Applicable Change Process:** Deliverable Change Process (PMG)

**Baseline:** V1.0

**Description:** Provides the required information to enable the CSDs/CBs to carry out testing activities. Provides details on the organisation of testing, processes, roles and responsibilities, monitoring and reporting, test coverage matrixes for each test stage, and the principles of the execution plan for each test stage.

**WBS:**

**Programme Workstream:** CLIENT READINESS

**Deliverable Stream:** USER TRAINING AND TESTING

**Deliverable Substream:** USER TESTING PREPARATION

**Deliverable:** Migration Strategy

**ID:** 25

**Document Category:** T2S Project Documents

**Licence to Copy / Use**

**Optional:**

**R – Responsible:** Eurosystem

**A – Accountable:** PMG

**C – Consultation:** CSD, CB

**I – Information:**

**Applicable Change Process:** Final

**Baseline:** V1.0

**Description:** The scope of this document is to present the migration approach that will be used to prepare and conduct the migration in T2S. This document covers the framework applicable for the migration, the roles and responsibilities of the parties involved and the activities to be performed to prepare, execute and monitor the migration process.

**WBS:**

**Programme Workstream:** OPERATIONAL READINESS

**Deliverable Stream:** MIGRATION

**Deliverable Substream:** MIGRATION PREPARATION



# Currency Participation Agreement

## SCHEDULE 2 – ANNEX 8 – T2S list of Deliverables

**Deliverable:** Standard Migration Plan

**ID:** 26

**Document Category:** T2S Project Documents

**Licence to Copy / Use**

**Optional:**

**R – Responsible:** Eurosystem

**A – Accountable:** PMG

**C – Consultation:** CSD, CB

**I – Information:**

**Applicable Change Process:** Deliverable Change Process (PMG)

**Baseline:** V1.0

**Description:** This document presents the detailed standard and tailored plans for all T2S Contracting Parties. The tailored migration plan per group of CSDs/CBs or individual CSD/CB depending on its specificities.

### WBS:

**Programme Workstream:** OPERATIONAL READINESS

**Deliverable Stream:** MIGRATION

**Deliverable Substream:** MIGRATION PREPARATION

**Deliverable:** Detailed migration weekend script

**ID:** 27

**Document Category:** T2S Project Documents

**Licence to Copy / Use**

**Optional:**

**R – Responsible:** Eurosystem

**A – Accountable:** PMG

**C – Consultation:** CSD, CB

**I – Information:**

**Applicable Change Process:** Deliverable Change Process (PMG)

**Baseline:** V1.0

**Description:** The scope of this document is to provide the T2S Actors with the required information to execute the tasks requested for the preparation and execution of the T2S migration weekend. Tasks detailing the pre-migration phase (load static data...) and migration phase (detailed migration sequence of activities and organisation) are covered. Rollback and fallback procedures are presented as potential consequences of the decision points to be taken during the migration WE. More precisely, this document covers the schedule, the roles and responsibilities, and the identification of the success factors. The document takes into account the lessons learnt from the previous waves.

### WBS:

**Programme Workstream:** OPERATIONAL READINESS

**Deliverable Stream:** MIGRATION

**Deliverable Substream:** MIGRATION PREPARATION

# Currency Participation Agreement

## SCHEDULE 2 – ANNEX 8 – T2S list of Deliverables

**Deliverable:** CSD Certification Test Cases

**ID:** 30

**Document Category:** T2S Project Documents

**Licence to Copy / Use**

**Optional:**

**R – Responsible:** Eurosystem

**A – Accountable:** PMG

**C – Consultation:**

**I – Information:** CSD

**Applicable Change Process:** Deliverable Change Process (PMG)

**Baseline:** V1.0

**Description:** This deliverable specifies the technical requirements that a CSD must fulfil as well as the test cases in a pre-defined, standardised format that a CSD must execute successfully as prerequisite before entering in the Community Testing Stage in User Testing. The successful execution of certification test cases by a CSD ensures that a CSD creates no adverse effects on T2S or T2S Actors.

### WBS:

**Programme Workstream:** CLIENT READINESS

**Deliverable Stream:** USER TRAINING AND TESTING

**Deliverable Substream:** USER TESTING PREPARATION

**Deliverable:** T2S Non-Functional Testing Scenarios

**ID:** 32

**Document Category:** T2S Project Documents

**Licence to Copy / Use**

**Optional:**

**R – Responsible:** Eurosystem

**A – Accountable:** Eurosystem

**C – Consultation:**

**I – Information:** CSD, CB

**Applicable Change Process:** Deliverable Change Process (PMG)

**Baseline:** V1.0

**Description:** This deliverable documents the test scenarios and test cases that the Eurosystem will execute to verify that T2S complies with the non-functional user requirements. The non-functional testing comprises performance testing, Disaster Recovery and Business Continuity testing, and compliance with information security requirements.

### WBS:

**Programme Workstream:** OPERATIONAL READINESS

**Deliverable Stream:** NETWORK AND CONNECTIVITY

**Deliverable Substream:** NETWORK AND CONNECTIVITY

# Currency Participation Agreement

## SCHEDULE 2 – ANNEX 8 – T2S list of Deliverables

**Deliverable:** CSD/CB's T2S Non-Compliance Notification

**ID:** 35

**Document Category:** T2S Project Documents

**Licence to Copy / Use**

**Optional:**

**R – Responsible:** CSD/CB

**A – Accountable:** CSD/CB

**C – Consultation:** Eurosystem (MCR)

**I – Information:**

**Applicable Change Process:** N/A

**Baseline:** V1.0

**Description:** This report is a deliverable of the CSD/CB in which the CSD/CB formally documents the specific reason or reasons for its refusal to accept T2S. The report must include the acceptance test scenarios and test cases that the CSD/CB considers to have failed to execute successfully in T2S.

**WBS:**

**Programme Workstream:** CLIENT READINESS

**Deliverable Stream:** USER TRAINING AND TESTING

**Deliverable Substream:** USER TESTING EXECUTION

**Deliverable:** CSD/CB's T2S Compliance Confirmation

**ID:** 36

**Document Category:** T2S Project Documents

**Licence to Copy / Use**

**Optional:**

**R – Responsible:** CSD/CB

**A – Accountable:** CSD/CB

**C – Consultation:** Eurosystem (MCR)

**I – Information:**

**Applicable Change Process:** N/A

**Baseline:** V1.0

**Description:** This deliverable is a standardised form that the Eurosystem provides to the CSDs/CBs and that a CSD/CB completes and returns to the Eurosystem to confirm its acceptance of T2S at the end of the CSD/CB Acceptance Testing Phase.

**WBS:**

**Programme Workstream:** CLIENT READINESS

**Deliverable Stream:** USER TRAINING AND TESTING

**Deliverable Substream:** USER TESTING EXECUTION

# Currency Participation Agreement

## SCHEDULE 2 – ANNEX 8 – T2S list of Deliverables

**Deliverable:** Eurosystem T2S Certification

**ID:** 37

**Document Category:** T2S Project Documents

**Licence to Copy / Use**

**Optional:**

**R – Responsible:** Eurosystem

**A – Accountable:** Eurosystem

**C – Consultation:**

**I – Information:** CSD, CB

**Applicable Change Process:** N/A

**Baseline:** V1.0

**Description:** This deliverable is the assessment of the Eurosystem whether or not a CSD, a CB or a DCP successfully completed its certification testing for this specific release of T2S. In case the assessment is negative, the Eurosystem formally documents the specific reason or reasons for its refusal to certify a T2S Actor for this specific release of T2S.

**WBS:**

**Programme Workstream:** CLIENT READINESS

**Deliverable Stream:** USER TRAINING AND TESTING

**Deliverable Substream:** USER TESTING EXECUTION

**Deliverable:** Testing Progress Report

**ID:** 39

**Document Category:** T2S Project Documents

**Licence to Copy / Use**

**Optional:**

**R – Responsible:** Eurosystem

**A – Accountable:** PMG

**C – Consultation:** CSD, CB

**I – Information:**

**Applicable Change Process:** Deliverable Change Process (PMG)

**Baseline:** V1.0

**Description:** Provides the status, the general progress, the measures to mitigate risks that could endanger the timely execution of test activities, and the progress against the planning (Eurosystem reports on the Test Plan, whilst the CSDs/CBs report on their Test Plan). This report will be delivered for the various testing phases of the T2S Programme (EAT and UT Stages). The progress report also includes the list of pending defects identified for the stage, which will be used to allow proper monitoring of the defects identified.

**WBS:**

**Programme Workstream:** CLIENT READINESS

**Deliverable Stream:** USER TRAINING AND TESTING

**Deliverable Substream:** USER TESTING EXECUTION

# Currency Participation Agreement

## SCHEDULE 2 – ANNEX 8 – T2S list of Deliverables

**Deliverable:** T2S Training Framework

**ID:** 40

**Document Category:** T2S Project Documents

**Licence to Copy / Use**

**Optional:**

**R – Responsible:** Eurosystem

**A – Accountable:** Eurosystem

**C – Consultation:**

**I – Information:** CSD, CB

**Applicable Change Process:** Deliverable Change Process (PMG)

**Baseline:** V1.0

**Description:** The training framework defines the scope of T2S training programme and its related training objectives. It specifies the required set of training documents and materials, the intended audience definition, the training organisation (train the trainer concept) and the high-level training timeline.

**WBS:**

**Programme Workstream:** CLIENT READINESS

**Deliverable Stream:** USER TRAINING AND TESTING

**Deliverable Substream:** TRAINING PREPARATION

**Deliverable:** Registration Guide for User Testing

**ID:** 42

**Document Category:** T2S Project Documents

**Licence to Copy / Use**

**Optional:**

**R – Responsible:** Eurosystem

**A – Accountable:** Eurosystem

**C – Consultation:**

**I – Information:** CSD, CB

**Applicable Change Process:** Deliverable Change Process (PMG)

**Baseline:** V1.0

**Description:** Contains the required details provided by the CSDs/CBs in order to carry out User Testing on the testing environments. Includes the full set of administrative forms required for the participation to the User Tests. It will enable the CSDs/CBs to describe their connectivity data, T2S Services used, initial static data such as accounts, static data for logically segregated testing, etc.

**WBS:**

**Programme Workstream:** CLIENT READINESS

**Deliverable Stream:** USER TRAINING AND TESTING

**Deliverable Substream:** USER TESTING PREPARATION

# Currency Participation Agreement

## SCHEDULE 2 – ANNEX 8 – T2S list of Deliverables

**Deliverable:** Implementation Guide for CSD Eligibility Criteria

**ID:** 43

**Document Category:** Legal Acts

**Licence to Copy / Use**

**Optional:**

**R – Responsible:** Eurosystem

**A – Accountable:** Eurosystem

**C – Consultation:**

**I – Information:** CSD, CB

**Applicable Change Process:** N/A

**Baseline:** V1.0

**Description:** This deliverable documents and explains the conditions that CSDs must fulfil to participate in T2S. The 5 criteria to be respected are defined under article 4.3 of the Framework Agreement. Also see Del ID 425 on "Proof of eligibility for participation in T2S".

**WBS:**

**Programme Workstream:** CLIENT READINESS

**Deliverable Stream:** SYNCHRONISATION AND ON-BOARDING

**Deliverable Substream:** CSD READINESS

**Deliverable:** T2S Release Note

**ID:** 44

**Document Category:** T2S Project Documents

**Licence to Copy / Use**

**Optional:**

**R – Responsible:** Eurosystem

**A – Accountable:** Eurosystem

**C – Consultation:**

**I – Information:** CSD, CB

**Applicable Change Process:** Deliverable Change Process (PMG)

**Baseline:** V1.0

**Description:** This deliverable details for T2S Actors Release changes and/or enhancements that the Eurosystem has made in a new version of the T2S software and includes a list of recommended regression tests for T2S Actors. It also documents any known defects in the software release.

**WBS:**

**Programme Workstream:** CLIENT READINESS

**Deliverable Stream:** USER TRAINING AND TESTING

**Deliverable Substream:** USER TESTING EXECUTION

# Currency Participation Agreement

## SCHEDULE 2 – ANNEX 8 – T2S list of Deliverables

**Deliverable:** CB Certification Test Cases

**ID:** 45

**Document Category:** T2S Project Documents

**Licence to Copy / Use**

**Optional:**

**R – Responsible:** Eurosystem

**A – Accountable:** PMG

**C – Consultation:**

**I – Information:** CB

**Applicable Change Process:** Deliverable Change Process (PMG)

**Baseline:** V1.0

**Description:** This deliverable documents the technical requirements that a CB must fulfil as well as in a pre-defined, standardised format the test scenarios and test case that a CB must execute successfully in T2S to obtain approval to connect directly to the T2S production environment. The document specifies the mandatory test scenarios and test cases by the role that the CB takes in T2S.

**WBS:**

**Programme Workstream:** CLIENT READINESS

**Deliverable Stream:** USER TRAINING AND TESTING

**Deliverable Substream:** USER TESTING PREPARATION

**Deliverable:** DCP Certification Test Cases

**ID:** 46

**Document Category:** T2S Project Documents

**Licence to Copy / Use**

**Optional:**

**R – Responsible:** Eurosystem

**A – Accountable:** PMG

**C – Consultation:** CSD

**I – Information:** DCP

**Applicable Change Process:** Deliverable Change Process (PMG)

**Baseline:** V1.0

**Description:** This deliverable documents the technical requirements that a DCP (including directly connected DCAHs) must fulfil as well as in a pre-defined, standardised format the test scenarios and test case that a DCP must execute successfully in T2S to obtain approval to connect directly to the T2S production environment. The document specifies the mandatory test scenarios and test cases by the role that the DCP takes in T2S.

**WBS:**

**Programme Workstream:** CLIENT READINESS

**Deliverable Stream:** USER TRAINING AND TESTING

**Deliverable Substream:** USER TESTING PREPARATION

# Currency Participation Agreement

## SCHEDULE 2 – ANNEX 8 – T2S list of Deliverables

**Deliverable:** General Functional Specification (GFS)

**ID:** 49

**Document Category:** T2S Scope Defining Set of Documents

**Licence to Copy / Use**

**Optional:**

**R – Responsible:** Eurosystem

**A – Accountable:** CRG

**C – Consultation:** CSD, CB

**I – Information:**

**Applicable Change Process:** CRMP

**Baseline:** V4.0

**Description:** The specification documents the functional design of T2S and how the user requirements will be implemented from a functional perspective.

### WBS:

**Programme Workstream:** PRODUCT READINESS

**Deliverable Stream:** SPECIFICATION AND DOCUMENTATION

**Deliverable Substream:** SPECIFICATIONS

**Deliverable:** General Technical Design (GTD)

**ID:** 50

**Document Category:** T2S Specifications

**Licence to Copy / Use**

**Optional:**

**R – Responsible:** Eurosystem

**A – Accountable:** CRG

**C – Consultation:** CSD, CB

**I – Information:**

**Applicable Change Process:** Deliverable Change Process (CRG)

**Baseline:** V2.0

**Description:** The document describes the design of T2S from the technical infrastructure and architecture perspective. CSDs and CBs were consulted on specific chapters related to connectivity issues (Chapters 3.5 and 3.6)

### WBS:

**Programme Workstream:** PRODUCT READINESS

**Deliverable Stream:** SPECIFICATION AND DOCUMENTATION

**Deliverable Substream:** SPECIFICATIONS



# Currency Participation Agreement

## SCHEDULE 2 – ANNEX 8 – T2S list of Deliverables

**Deliverable:** General Specification (GS)

**ID:** 51

**Document Category:** T2S Specifications

**Licence to Copy / Use**

**Optional:**

**R – Responsible:** Eurosystem

**A – Accountable:** Eurosystem

**C – Consultation:**

**I – Information:** CSD, CB

**Applicable Change Process:** N/A

**Baseline:** V2.0

**Description:** The document represents the high-level description of T2S as an executive summary. It aims at giving a global and comprehensive picture of the T2S solution and at explaining how the User Requirements which are not covered by the General Functional Specifications (GFS) and General Technical Design (GTD) will be fulfilled.

**WBS:**

**Programme Workstream:** PRODUCT READINESS

**Deliverable Stream:** SPECIFICATION AND DOCUMENTATION

**Deliverable Substream:** SPECIFICATIONS

**Deliverable:** User Requirement Document (URD)

**ID:** 64

**Document Category:** T2S Scope Defining Set of Documents

**Licence to Copy / Use**

**Optional:**

**R – Responsible:** Eurosystem

**A – Accountable:** CRG

**C – Consultation:** CSD, CB

**I – Information:**

**Applicable Change Process:** CRMP

**Baseline:** V5.01

**Description:** In line with the Schedule 1 definition: [means the latest available document setting out the User requirements for T2S Services as published by the ECB as subsequently amended through the Change and Re-lease Management process.] This document defines the requirements for the T2S Services eg: the Cross Border DVP settlement in Central Bank Money.

**WBS:**

**Programme Workstream:** PRODUCT READINESS

**Deliverable Stream:** SPECIFICATION AND DOCUMENTATION

**Deliverable Substream:** REQUIREMENTS

# Currency Participation Agreement

## SCHEDULE 2 – ANNEX 8 – T2S list of Deliverables

**Deliverable:** Tender for Network Connectivity (VAN)

**ID:** 69

**Document Category:** T2S Specifications

**Licence to Copy / Use**

**Optional:**

**R – Responsible:** Eurosystem

**A – Accountable:** Eurosystem

**C – Consultation:**

**I – Information:** CSD, CB

**Applicable Change Process:** N/A

**Baseline:** V1.0

**Description:** The tender defines the requirements that a potential network provider must fulfil to be considered suitable for offering its network services to the T2S community.

### WBS:

**Programme Workstream:** OPERATIONAL READINESS

**Deliverable Stream:** NETWORK AND CONNECTIVITY

**Deliverable Substream:** NETWORK AND CONNECTIVITY

**Deliverable:** Processes and Tools for Data Migration

**ID:** 73

**Document Category:** T2S Project Documents

**Licence to Copy / Use**

**Optional:**

**R – Responsible:** Eurosystem

**A – Accountable:** PMG

**C – Consultation:** CSD, CB

**I – Information:**

**Applicable Change Process:** Deliverable Change Process (PMG)

**Baseline:** V1.0

**Description:** The document defines the steps with their sequencing that a CSD or CB needs to undertake to successfully migrate to T2S. Furthermore, it explains the various options that T2S provides to migrate specific types of data to T2S and to ensure the integrity of migrated data. It also documents the specific migration obligations of CSDs and CBs resulting from the phased migration in multiple waves.

### WBS:

**Programme Workstream:** OPERATIONAL READINESS

**Deliverable Stream:** MIGRATION

**Deliverable Substream:** MIGRATION PREPARATION

# Currency Participation Agreement

## SCHEDULE 2 – ANNEX 8 – T2S list of Deliverables

**Deliverable:** Registration Guide for Migration

**ID:** 74

**Document Category:** T2S Project Documents

**Licence to Copy / Use**

**Optional:**

**R – Responsible:** Eurosystem

**A – Accountable:** Eurosystem

**C – Consultation:**

**I – Information:** CSD, CB

**Applicable Change Process:** Deliverable Change Process (PMG)

**Baseline:** V1.0

**Description:** This document gathers the full set of administrative forms required for set-up. This version will rely on the registration guide created for testing and will complement it with what is required for production.

### WBS:

**Programme Workstream:** OPERATIONAL READINESS

**Deliverable Stream:** MIGRATION

**Deliverable Substream:** MIGRATION PREPARATION

**Deliverable:** Business Process Description (BPD)

**ID:** 75

**Document Category:** T2S Specifications

**Licence to Copy / Use**

**Optional:**

**R – Responsible:** Eurosystem

**A – Accountable:** Eurosystem

**C – Consultation:**

**I – Information:** CSD, CB

**Applicable Change Process:** Deliverable Change Process (CRG)

**Baseline:** V1.0

**Description:** This document provides end-to-end business process descriptions for the life cycle of the different business operations (e.g. distribution or transformation). It describes which T2S services a CSD and CB may use to correctly and completely process a specific business operation.

### WBS:

**Programme Workstream:** PRODUCT READINESS

**Deliverable Stream:** SPECIFICATION AND DOCUMENTATION

**Deliverable Substream:** DOCUMENTATION

# Currency Participation Agreement

## SCHEDULE 2 – ANNEX 8 – T2S list of Deliverables

**Deliverable:** T2S Glossary

**ID:** 78

**Document Category:** T2S Project Documents

**Licence to Copy / Use**

**Optional:**

**R – Responsible:** Eurosystem

**A – Accountable:** Eurosystem

**C – Consultation:** CSD, CB

**I – Information:**

**Applicable Change Process:** Deliverable Change Process (PMG)

**Baseline:** V1.0

**Description:** This document presents, encompasses and harmonises all the definitions included in the various T2S deliverables.

### WBS:

**Programme Workstream:** PRODUCT READINESS

**Deliverable Stream:** SPECIFICATION AND DOCUMENTATION

**Deliverable Substream:** DOCUMENTATION

**Deliverable:** User Testing Calendar

**ID:** 88

**Document Category:** T2S Project Documents

**Licence to Copy / Use**

**Optional:**

**R – Responsible:** Eurosystem

**A – Accountable:** PMG

**C – Consultation:** CSD, CB

**I – Information:**

**Applicable Change Process:** Deliverable Change Process (PMG)

**Baseline:** V1.0

**Description:** This document provides on the availability of the testing environments and the process scheduling for each of the test environments (e.g. slow motion, fast forward or business day mode).

### WBS:

**Programme Workstream:** CLIENT READINESS

**Deliverable Stream:** USER TRAINING AND TESTING

**Deliverable Substream:** USER TESTING PREPARATION

# Currency Participation Agreement

## SCHEDULE 2 – ANNEX 8 – T2S list of Deliverables

**Deliverable:** Eurosystem Acceptance Testing Assessment Report

**ID:** 101

**Document Category:** T2S Project Documents

**Licence to Copy / Use**

**Optional:**

**R – Responsible:** Eurosystem

**A – Accountable:** Eurosystem

**C – Consultation:**

**I – Information:** CSD, CB

**Applicable Change Process:** N/A

**Baseline:** V1.0

**Description:** The report documents the Eurosystem's assessment whether T2S fulfils the User Requirements. It documents pending defects with a timeline for their resolution. Where necessary, it includes workarounds for remaining errors.

### WBS:

**Programme Workstream:** PRODUCT READINESS

**Deliverable Stream:** EUROSYSYSTEM ACCEPTANCE TEST

**Deliverable Substream:** EAT EXECUTION

**Deliverable:** T2S Smooth Cross-CSD Settlement

**ID:** 107

**Document Category:** T2S Project Documents

**Licence to Copy / Use**

**Optional:**

**R – Responsible:** Eurosystem

**A – Accountable:** CRG

**C – Consultation:** CSD

**I – Information:**

**Applicable Change Process:** Deliverable Change Process (PMG)

**Baseline:** V1.0

**Description:** The document presents the CSD specificities that the T2S users must take into account when instructing securities issued in or when settling with the counterparts in CSDs other than the in which they hold their Securities Account. The document defines and describes the additional conditions required to allow the smooth processing of cross-CSD instructions. This document is also discussed at the AG.

### WBS:

**Programme Workstream:** PRODUCT READINESS

**Deliverable Stream:** SPECIFICATION AND DOCUMENTATION

**Deliverable Substream:** DOCUMENTATION

# Currency Participation Agreement

## SCHEDULE 2 – ANNEX 8 – T2S list of Deliverables

**Deliverable:** Adaptation to Cross-CSD Settlement

**ID:** 109

**Document Category:** T2S Project Documents

**Licence to Copy / Use**

**Optional:**

**R – Responsible:** Eurosystem

**A – Accountable:** CRG

**C – Consultation:** CSD

**I – Information:**

**Applicable Change Process:** Deliverable Change Process (PMG)

**Baseline:** V2.0

**Description:** This document is based on the T2S Smooth Cross-CSD settlement deliverable (ID 107), it presents the conclusions of the subgroup working on this topic (detailed analysis of deliverable 107)..

### WBS:

**Programme Workstream:** PRODUCT READINESS

**Deliverable Stream:** SPECIFICATION AND DOCUMENTATION

**Deliverable Substream:** DOCUMENTATION

**Deliverable:** T2S Training Manual

**ID:** 110

**Document Category:** T2S Project Documents

**Licence to Copy / Use**

**Optional:**

**R – Responsible:** Eurosystem

**A – Accountable:** Eurosystem

**C – Consultation:**

**I – Information:** CSD, CB

**Applicable Change Process:** Deliverable Change Process (PMG)

**Baseline:** V1.0

**Description:** The Eurosystem provides the CSDs/CBs with training on a train-the-trainer basis. If requested by a CSD/ CB, the Eurosystem can also provide these trainings (train the trainer concept) to the CSD/CB customers. These training materials are in line with internal documents such as the Training Framework and Training material guidelines. This document is delivered by topic: Basic, Technical, Functional, Operational, Testing and Migration. The plan details the versioning and delivery dates for each topic.

### WBS:

**Programme Workstream:** CLIENT READINESS

**Deliverable Stream:** USER TRAINING AND TESTING

**Deliverable Substream:** TRAINING PREPARATION

# Currency Participation Agreement

## SCHEDULE 2 – ANNEX 8 – T2S list of Deliverables

**Deliverable:** Risk Analysis on T2S Compliance with T2S Information Security Policy **ID:** 116

**Document Category:** T2S Project Documents

**Licence to Copy / Use**

**Optional:**

**R – Responsible:** Eurosystem

**A – Accountable:** Eurosystem

**C – Consultation:** CSD, CB

**I – Information:**

**Applicable Change Process:** Deliverable Change Process (PMG)

**Baseline:** V1.0

**Description:** This document presents Eurosystem analysis on the compliance of T2S with the Information Security requirements and policy, as defined in the FA/CPA.

### WBS:

**Programme Workstream:** OPERATIONAL READINESS

**Deliverable Stream:** INFORMATION SECURITY

**Deliverable Substream:** INFORMATION SECURITY

**Deliverable:** Non Functional Test Report **ID:** 141

**Document Category:** T2S Project Documents

**Licence to Copy / Use**

**Optional:**

**R – Responsible:** Eurosystem

**A – Accountable:** Eurosystem

**C – Consultation:**

**I – Information:** CSD, CB

**Applicable Change Process:** Deliverable Change Process (PMG)

**Baseline:** V1.0

**Description:** This report documents the results of the non-functional testing of T2S by the Eurosystem, (e.g. scalability testing, Disaster Recovery testing and Business Continuity testing).

### WBS:

**Programme Workstream:** OPERATIONAL READINESS

**Deliverable Stream:** NETWORK AND CONNECTIVITY

**Deliverable Substream:** NETWORK AND CONNECTIVITY

# Currency Participation Agreement

## SCHEDULE 2 – ANNEX 8 – T2S list of Deliverables

**Deliverable:** User Testing Stage Report

**ID:** 201

**Document Category:** T2S Project Documents

**Licence to Copy / Use**

**Optional:**

**R – Responsible:** Eurosystem

**A – Accountable:** PMG

**C – Consultation:** CSD, CB

**I – Information:**

**Applicable Change Process:** Deliverable Change Process (PMG)

**Baseline:** V1.1

**Description:** Includes a check of the exit and entry criteria for a testing stage, an overview of the test results by testing stage, overview of functionalities delivered, resolved defects (defect ID, defect title, severity, T2S Service affected, impacted parties) and remaining known defects for the next testing stage. Used for the go-no-go decision on the next User Testing stage.  
It includes the lessons learnt during the test stage.  
Provided at the end of: Connectivity set-up, Interoperability, Community, Business Day (By wave).

### WBS:

**Programme Workstream:** CLIENT READINESS

**Deliverable Stream:** USER TRAINING AND TESTING

**Deliverable Substream:** USER TESTING EXECUTION

**Deliverable:** Schedule 5 - Service Description

**ID:** 376

**Document Category:** Legal Acts

**Licence to Copy / Use**

**Optional:**

**R – Responsible:** Eurosystem

**A – Accountable:** Eurosystem

**C – Consultation:** CSD, CB

**I – Information:**

**Applicable Change Process:** FA/CPA

**Baseline:** FA/CPA

**Description:** This deliverable classifies and decomposes the set of services that T2S will deliver. It provides a description from the T2S clients' perspective for each class of service and well as services within each class. It also defines the service boundaries for the services.

### WBS:

**Programme Workstream:** CLIENT READINESS

**Deliverable Stream:** CONTRACTUAL FRAMEWORK

**Deliverable Substream:** FRAMEWORK AGREEMENT



# Currency Participation Agreement

## SCHEDULE 2 – ANNEX 8 – T2S list of Deliverables

**Deliverable:** Proof of eligibility for participation in T2S

**ID:** 425

**Document Category:** T2S Project Documents

**Licence to Copy / Use**

**Optional:**

**R – Responsible:** CSD

**A – Accountable:** CSD

**C – Consultation:** Eurosystem

**I – Information:**

**Applicable Change Process:** Deliverable Change Process (PMG)

**Baseline:** V1.0

**Description:** This document is the standardised form that CSDs must complete for CSDs to document their compliance with the Eligibility Criteria for Participation in T2S. It describes the type and scope of documentation that the CSDs must provide as proof of eligibility. Also see Del ID 43 on "Implementation Guide for CSD Eligibility Criteria".

**WBS:**

**Programme Workstream:** CLIENT READINESS

**Deliverable Stream:** SYNCHRONISATION AND ON-BOARDING

**Deliverable Substream:** CSD READINESS

**Deliverable:** CSD Feasibility Assessment

**ID:** 430

**Document Category:** T2S Project Documents

**Licence to Copy / Use**

**Optional:**

**R – Responsible:** CSD

**A – Accountable:** CSD

**C – Consultation:**

**I – Information:** Eurosystem

**Applicable Change Process:** N/A

**Baseline:** V1.0

**Description:** This deliverable presents the results of the CSD feasibility assessment. It contains a view on their internal adaptation approach and planning. It also presents the efforts the CSD is going to undertake to coordinate the readiness of their clients. As part of this feasibility assessment, CSD will also list the potential showstoppers they have identified. CSDs will include in their assessment a date for their migration to T2S that will be the basis for CSDs for CSD to agree and make their proposal for the composition and timing of migration waves to T2S.

**WBS:**

**Programme Workstream:** CLIENT READINESS

**Deliverable Stream:** SYNCHRONISATION AND ON-BOARDING

**Deliverable Substream:** CSD READINESS

# Currency Participation Agreement

## SCHEDULE 2 – ANNEX 8 – T2S list of Deliverables

**Deliverable:** CB Feasibility Assessment

**ID:** 440

**Document Category:** T2S Project Documents

**Licence to Copy / Use**

**Optional:**

**R – Responsible:** CB

**A – Accountable:** CB

**C – Consultation:**

**I – Information:** Eurosystem

**Applicable Change Process:** N/A

**Baseline:** V1.0

**Description:** This deliverable presents the results of the CB feasibility assessment. It contains a view on their internal adaptation approach and planning. It also presents the efforts the CB is going to undertake to coordinate the readiness of their clients. As part of this feasibility assessment, CB will also list the potential showstoppers they have identified. CBs will include in their assessment a date for their migration to T2S that will be the basis for CBs for CB to agree and make their proposal for the composition and timing of migration waves to T2S.

### WBS:

**Programme Workstream:** CLIENT READINESS

**Deliverable Stream:** SYNCHRONISATION AND ON-BOARDING

**Deliverable Substream:** CB READINESS

**Deliverable:** EAT Documentation

**ID:** 466

**Document Category:** T2S Project Documents

**Licence to Copy / Use**

**Optional:**

**R – Responsible:** Eurosystem

**A – Accountable:** Eurosystem

**C – Consultation:**

**I – Information:** CSD, CB

**Applicable Change Process:** Deliverable Change Process (PMG)

**Baseline:** V1.0

**Description:** Provide, for informational purposes only, details of Eurosystem acceptance test documentation (test calendars etc.) to Contracting CSDs pursuant to ECB's obligations under the Framework Agreement Schedule 3 section 3.2.1 paragraph (ii) and section 3.2.2 paragraph (ii)"

### WBS:

**Programme Workstream:** PRODUCT READINESS

**Deliverable Stream:** EUROSYSTEM ACCEPTANCE TEST

**Deliverable Substream:** EAT PREPARATION

# Currency Participation Agreement

## SCHEDULE 2 – ANNEX 8 – T2S list of Deliverables

**Deliverable:** CSD Market Specific Test Cases for Eurosystem Acceptance Test **ID:** 467

**Document Category:** T2S Project Documents

**Licence to Copy / Use**

**Optional:**

**R – Responsible:** CSD

**A – Accountable:** CSD

**C – Consultation:**

**I – Information:** Eurosystem

**Applicable Change Process:** Deliverable Change Process (PMG)

**Baseline:** V1.0

**Description:** This deliverable documents the market-specific test cases that a CSD would like the Eurosystem to execute as part of its Eurosystem Acceptance Testing in advance of the User Testing Execution Phase.

### WBS:

**Programme Workstream:** PRODUCT READINESS

**Deliverable Stream:** EUROSISTEM ACCEPTANCE TEST

**Deliverable Substream:** EAT PREPARATION

**Deliverable:** CB Market Specific Test Cases for Eurosystem Acceptance Test **ID:** 470

**Document Category:** T2S Project Documents

**Licence to Copy / Use**

**Optional:**

**R – Responsible:** CB

**A – Accountable:** CB

**C – Consultation:**

**I – Information:** Eurosystem

**Applicable Change Process:** Deliverable Change Process (PMG)

**Baseline:** V1.0

**Description:** This deliverable documents the market-specific test cases that a CB would like the Eurosystem to execute as part of its Eurosystem Acceptance Testing in advance of the User Testing Execution Phase.

### WBS:

**Programme Workstream:** PRODUCT READINESS

**Deliverable Stream:** EUROSISTEM ACCEPTANCE TEST

**Deliverable Substream:** EAT PREPARATION

# Currency Participation Agreement

## SCHEDULE 2 – ANNEX 8 – T2S list of Deliverables

**Deliverable:** End of Migration report

**ID:** 550

**Document Category:** T2S Project Documents

**Licence to Copy / Use**

**Optional:**

**R – Responsible:** Eurosystem

**A – Accountable:** PMG

**C – Consultation:** CSD, CB

**I – Information:**

**Applicable Change Process:** Deliverable Change Process (PMG)

**Baseline:** V1.0

**Description:** This deliverable provides after the go-live of each migration wave the lessons-learnt from the respective migration wave to identify and provide recommendations on potential improvements in the scope and content of the User Testing Phase; migration activities, procedures and checkpoints; and operational procedures and controls.

**WBS:**

**Programme Workstream:** OPERATIONAL READINESS

**Deliverable Stream:** MIGRATION

**Deliverable Substream:** MIGRATION WEEKEND (WAVE 1)

**Deliverable:** Proposal on the Composition and Timing of the Migration Waves

**ID:** 593

**Document Category:** T2S Project Documents

**Licence to Copy / Use**

**Optional:**

**R – Responsible:** CSD/CB

**A – Accountable:** CSD/CB

**C – Consultation:** Eurosystem

**I – Information:**

**Applicable Change Process:** Deliverable Change Process (PMG)

**Baseline:** V1.0

**Description:** This deliverable documents the joint proposal of CSDs/CBs on the composition and timing of the migration waves for the go-live of the initial T2S release. It forms the basis for the Eurosystem decision on the composition and timing of the migration waves.

**WBS:**

**Programme Workstream:** OPERATIONAL READINESS

**Deliverable Stream:** MIGRATION

**Deliverable Substream:** MIGRATION PREPARATION

## CURRENCY PARTICIPATION AGREEMENT

### SCHEDULE 2 – ANNEX 9

#### T2S LIST OF SYNCHRONISATION POINTS

***Disclaimer:***

Planning is an ongoing process and Annexes with planning elements are subject to change during the lifetime of a project. Planning workshops with CSDs and CBs will continue to agree on the planning for Connectivity, User Testing and Migration. Subsequent plan updates follow the process, documented in the Schedule 2, Section 7.

Annexes 2, 3, 4, 7, 8, 9 and 10 document the planning status as at 7 Nov. 2011.

# Currency Participation Agreement

## Schedule 2 – Annex 9 – T2S list of Synchronisation points

### Introduction:

To ease the readability of the Synchronisation Points here is a drawing presenting the sequencing and main dependencies. For the exact timing please refer to the details of each Synchronisation Points.

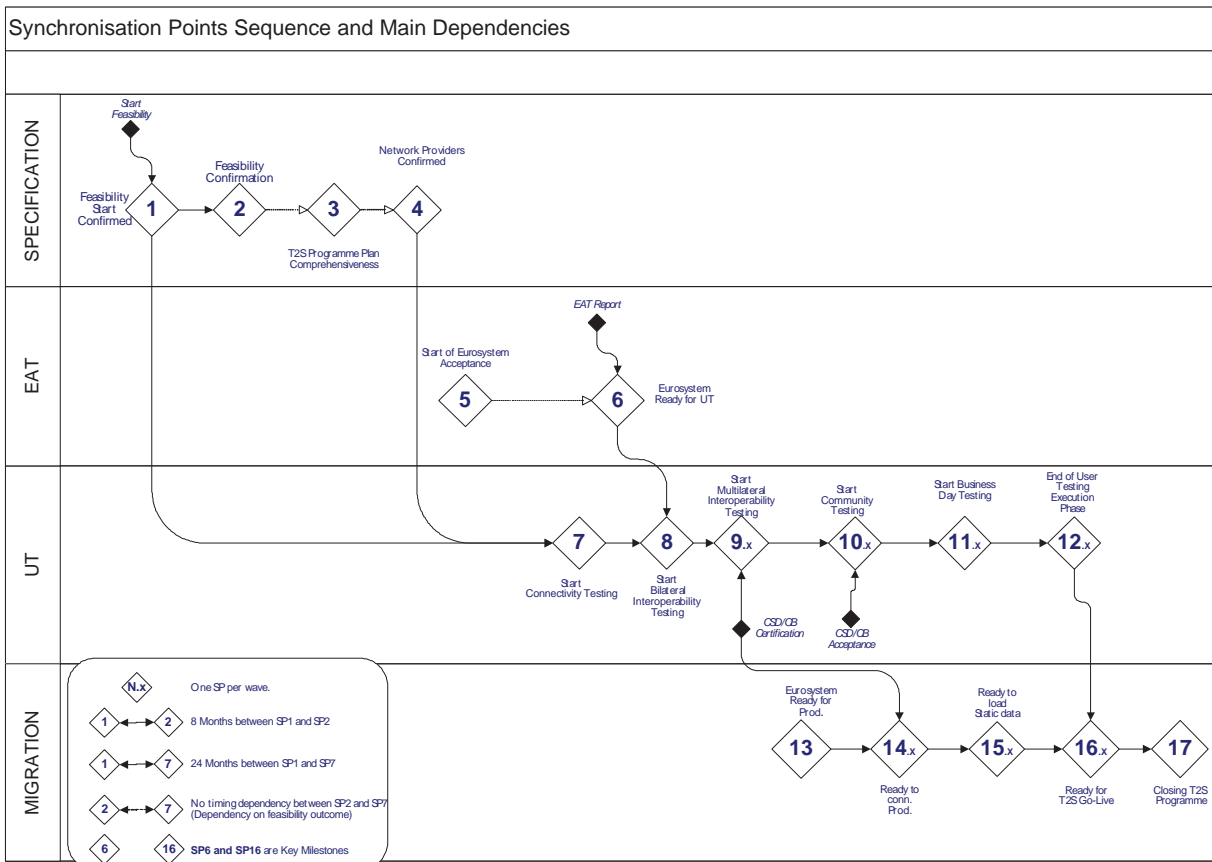

DARWIN: 42344421

# Currency Participation Agreement

## SCHEDULE 2 – ANNEX 9 – T2S list of Synchronisation points

---

### SP1 Start CSD/CB Feasibility Assessment Confirmed

20/12/11

SP1 marks the agreement between the Eurosystem and the respective CSDs and CBs that the Eurosystem has provided the specifications and documents to the CSDs and CBs in order for them to confirm that they have started their detailed feasibility assessment for the adaptation of their IT system and processes to T2S.

Plan reference ID 2006100

#### Eurosystem:

The Eurosystem confirms that it has provided the specifications and documents in the required scope and quality.

#### CSDs and CBs:

Each CSD and CB confirms that the Eurosystem has delivered the complete set of specifications and documents for the feasibility assessment. Each CSD and CB has confirmed that it has initiated its feasibility assessment.

---

#### Checklist:

##### Description:

Del ID: Owner: Plan ID: Date:

<input type="checkbox"/> [Deliverable] - General Function Specification (GFS) V 4.0	49	Eurosystem	74100	31/05/10
<input type="checkbox"/> [Deliverable] - Graphical User Interface (GUI) Business Functionalities	3	Eurosystem	281100	28/02/11
<input type="checkbox"/> Delivery GFS Note	49	Eurosystem	74500	01/06/11
<input type="checkbox"/> [Deliverable] - T2S Smooth Cross CSD settlement Report V1.0	107	Eurosystem	259100	30/06/11
<input type="checkbox"/> [Deliverable] - Service Description	376	Eurosystem	1310380	21/07/11
<input type="checkbox"/> [Deliverable] - User Detailed Functional Specification (UDFS) V1.2	6	Eurosystem	211100	31/10/11
<input type="checkbox"/> Start feasibility study		CSDs,CBs	211200	02/11/11
<input type="checkbox"/> [Deliverable] - User Requirement Document (URD) 5.01	64	Eurosystem	16100	17/11/11
<input type="checkbox"/> [Deliverable] - Business Process Description V 1.0 (BPD)	75	Eurosystem	230000	18/11/11
<input type="checkbox"/> [Deliverable] - Legal Act of Implementation Guide for CSD Eligibility Criteria V2.0	43	Eurosystem	623900	28/11/11
<input type="checkbox"/> Confirm comprehensiveness to start feasibility assessment		CSDs,CBs	536200	15/12/11

# Currency Participation Agreement

## SCHEDULE 2 – ANNEX 9 – T2S list of Synchronisation points

---

### SP2 Feasibility Confirmation by CSD/CB

10/08/12

---

SP2 marks the confirmation by CSDs and CBs that the adaptation of their IT systems and processes to interoperate with T2S are feasible from a functional and time perspective.

Plan reference ID 2007100

#### Eurosystem:

Based on the documentation from CSDs and CBs, defined as deliverables for this synchronisation point, the Eurosystem confirms that the T2S Programme Plan Assumptions for the overall T2S Programme Plan remain valid. It performs an impact assessment to ensure that any changes in assumptions do not have a material impact on the T2S Programme, and informs the T2S governance bodies if this is the case.

#### CSDs and CBs:

CSDs and CBs have reviewed the specifications and documents that the Eurosystem delivered for SP1 and confirm that it is feasible to adapt their IT systems and processes to interoperate with T2S. As part of their feasibility assessment, CSDs and CBs have identified their approach to the adaptation of their IT systems as well as impacts on processes and potential changes to their service offering. They have identified and logged potential showstoppers. CSDs and CBs have completed their high-level planning for going live with T2S and communicated their planning to the Eurosystem. The CSDs and CBs have submitted a proposal for the composition of the migration waves.

---

#### Checklist:

##### Description:

	<u>Del ID:</u>	<u>Owner:</u>	<u>Plan ID:</u>	<u>Date:</u>
<input type="checkbox"/> SP1 - Start Feasibility Confirmed			2006100	20/12/11
<input type="checkbox"/> [Deliverable] - CSD Feasibility Assessment	430	CSDs	213100	29/06/12
<input type="checkbox"/> [Deliverable] - CB Feasibility Assessment	440	CBs	546500	29/06/12
<input type="checkbox"/> [Deliverable] - Composition and Timing Migration Waves by CSDs/CBs	593	CSDs, CBs	546350	03/08/12
<input type="checkbox"/> Assessment of feasibility confirmation		Eurosystem	538200	10/08/12



# Currency Participation Agreement

## SCHEDULE 2 – ANNEX 9 – T2S list of Synchronisation points

---

### SP3 T2S Programme Plan Comprehensiveness

17/12/12

SP 3 marks the mutual assessment and confirmation that the T2S Programme Plan and the CSDs' and the CBs' plans are comprehensive and adequately reflect any agreed additional specifications or deliverables.

Plan reference ID 2007200

#### Eurosystem:

The Eurosystem provides a status on the T2S progress so far and confirms that the actual T2S Programme Plan is comprehensive and adequate.

#### CSDs and CBs:

The objective of this checkpoint is to verify that each CSD and CB has conducted an internal impact assessment for the implementation of the CASG Standards and other harmonisation initiatives on their own project plan to adapt to T2S. It is also an interim verification point to validate the initial assessment made on SP 2.

---

#### Checklist:

##### Description:

	<u>Del ID:</u>	<u>Owner:</u>	<u>Plan ID:</u>	<u>Date:</u>
<input type="checkbox"/> SP2 - Feasibility Confirmation by CSD/CB			2007100	10/08/12
<input type="checkbox"/> Confirmation of the Timing and Composition of Migration Waves by Eurosystem		Eurosystem	1209150	08/10/12
<input type="checkbox"/> [Deliverable] - Adaptation to Cross CSD settlement Report	109	Eurosystem	262000	20/11/12
<input type="checkbox"/> Update on CB Feasibility Assessment		CBs	553200	17/12/12
<input type="checkbox"/> Update on CSD Feasibility Assessment		CSDs	553000	17/12/12
<input type="checkbox"/> Confirmation of T2S programme plan status and achieved milestones		Eurosystem	540800	17/12/12

# Currency Participation Agreement

## SCHEDULE 2 – ANNEX 9 – T2S list of Synchronisation points

---

### SP4 Network Providers Confirmed

24/04/14

---

SP 4 marks confirmation that the selected network providers fulfil the technical requirements, as required by the tender.

Plan reference ID 2008100

#### Eurosystem:

The Eurosystem and the selected Network Service Providers (NSP) undertake proof of concept and Network Acceptance Tests (using testing environment) to demonstrate that the NSPs fulfil the technical requirements, as required in the tender in order to provide certainty to CSDs and CBs of the NSP's capability to support T2S connectivity. The Eurosystem presents the results of the Network Acceptance Tests confirming the ability of the NSPs to cope with the defined requirements.

#### CSDs and CBs:

The CSDs and CBs have finalised their contracts with their selected Network Service Provider.

---

#### Checklist:

##### Description:

	<u>Del ID:</u>	<u>Owner:</u>	<u>Plan ID:</u>	<u>Date:</u>
<input type="checkbox"/> [Deliverable] - Tender for Network Connectivity (VAN)	69	Eurosystem	1059100	08/07/11
<input type="checkbox"/> Signature of Network Service Provider Agreement		Eurosystem	1061100	31/01/12
<input type="checkbox"/> CSD: Network Agreement Contract signed		CSDs	1063120	11/04/14
<input type="checkbox"/> CB: Network Agreement Contract signed		CBs	1063190	11/04/14

# Currency Participation Agreement

## SCHEDULE 2 – ANNEX 9 – T2S list of Synchronisation points

---

### SP5 Start of Eurosystem Acceptance Test

15/01/14

---

SP 5 marks the start of the Eurosystem acceptance testing.

Plan reference ID 2009200

#### Eurosystem:

The Eurosystem has provided to CSDs and CBs the details of EAT documentation (e.g. test cases, test calendars, etc.). The Eurosystem confirms that it is ready to start the acceptance testing.

#### CSDs and CBs:

CSDs and CBs have reviewed the EAT documentation and potentially have identified specific additional test cases (optional) to increase the coverage of the EAT to market-specific requirements.

---

#### Checklist:

##### Description:

	<u>Del ID:</u>	<u>Owner:</u>	<u>Plan ID:</u>	<u>Date:</u>
<input type="checkbox"/> [Deliverable] - CSDs Market specific test cases for EAT V1.0	467	CSDs	451300	17/10/13
<input type="checkbox"/> [Deliverable] - CBs Market specific test cases for EAT V1.0	470	CBs	451700	17/10/13
<input type="checkbox"/> [Deliverable] - EAT Documentation V1.0 (EAT Test Sets)	466	Eurosystem	451400	14/11/13

# Currency Participation Agreement

## SCHEDULE 2 – ANNEX 9 – T2S list of Synchronisation points

### SP6 Eurosystem Ready for User Testing

02/09/14

SP 6 marks the start of the User Testing.

Plan reference ID 2009100

#### Eurosystem:

The Eurosystem confirms that the CSDs and CBs can start User Testing. The Eurosystem has set-up the T2S User Testing environment(s), implemented all supporting processes, trained the support teams and provided the required documentation. It has defined and communicated the test cases for certification of CSDs and CBs.

#### CSDs and CBs:

The CSDs and CBs have submitted their completed registration guide for User Testing and have finalised their verification test cases.

#### Checklist:

##### Description:

	<u>Del ID:</u>	<u>Owner:</u>	<u>Plan ID:</u>	<u>Date:</u>
<input type="checkbox"/> [Deliverable] - Data Migration Tools specifications and related procedures V1.0	73	Eurosystem	1206100	31/10/12
<input type="checkbox"/> [Deliverable] -User Hand Book (UHB) V1.0	9	Eurosystem	324100	27/12/12
<input type="checkbox"/> [Deliverable] - User Hand Book V2.0 (UHB)	9	Eurosystem	335200	17/09/13
<input type="checkbox"/> [Intermediate Deliverable] Draft Non functional Testing Report for information V1.0	141	Eurosystem	384200	17/12/13
<input type="checkbox"/> [Deliverable] - Registration Guide for User Testing	42	Eurosystem	607200	22/01/14
<input type="checkbox"/> [Deliverable] - Functional Training Materials	110	Eurosystem	568600	03/03/14
<input type="checkbox"/> [Deliverable] - User Testing Guide	18	Eurosystem	616100	12/03/14
<input type="checkbox"/> [Deliverable] - User Testing Calendar	88	Eurosystem	597300	13/03/14
<input type="checkbox"/> [Deliverable] - Testing Training Materials	110	Eurosystem	569000	03/06/14
<input type="checkbox"/> [Deliverable] - CB Certification Test Cases	45	Eurosystem	634700	19/06/14
<input type="checkbox"/> [Deliverable] - CSD Certification Test Cases	30	Eurosystem	634600	19/06/14
<input type="checkbox"/> Helpdesk set-up and Ready to support CSDs/CBs		Eurosystem	630200	23/06/14
<input type="checkbox"/> Delivery updated version of the EAT Status update		Eurosystem	634300	27/08/14
<input type="checkbox"/> [Deliverable] EAT Assessment Report	101	Eurosystem	493130	01/09/14

# Currency Participation Agreement

## SCHEDULE 2 – ANNEX 9 – T2S list of Synchronisation points

---

### SP7 Start Connectivity Testing

07/07/14

---

SP 7 marks the start of the connectivity tests by the CSDs and the CBs to the T2S User Testing environment(s).

Plan reference ID 2010100

#### Eurosystem:

The Eurosystem confirms the operational readiness of the networks for CSD and CB connectivity testing. The Eurosystem has issued the connectivity guides to the T2S user test environment(s). The Eurosystem confirms helpdesk is in place and problem management processes are operational.

#### CSDs and CBs:

CSDs and CBs have configured their network connectivity, according to the connectivity guide for the T2S user test environment(s). CSDs and CBs have completed the adaptation of their IT systems, according to T2S specifications and documentation. The starting date presented is the earliest starting date, since this is a bilateral phase, CSD and CB may decide to start this stage at a later date.

---

#### Checklist:

##### Description:

	<u>Del ID:</u>	<u>Owner:</u>	<u>Plan ID:</u>	<u>Date:</u>
<input type="checkbox"/> [Deliverable] - Connectivity Guide for VAN and Direct connectivity (Testing) V1.0	8	Eurosystem	1042200	30/07/13
<input type="checkbox"/> [Deliverable] - Basic Training Materials	110	Eurosystem	568100	02/09/13
<input type="checkbox"/> Start of VAN Networks connectivity tests with CSDs/CBs (Finish acceptance VAN		Eurosystem	1067100	04/11/13
<input type="checkbox"/> [Deliverable] - Technical Training Materials	110	Eurosystem	568400	02/12/13
<input type="checkbox"/> [Deliverable] - UDFS v.2.0	6	Eurosystem	223150	19/12/13
<input type="checkbox"/> Completed UT Registration Guide for User Testing (network registration)		CSDs,CBs	627100	11/04/14
<input type="checkbox"/> SP4 - Network Service Provider Confirmed			2008100	24/04/14
<input type="checkbox"/> UT environment ready		Eurosystem	634200	11/06/14

# Currency Participation Agreement

## SCHEDULE 2 – ANNEX 9 – T2S list of Synchronisation points

---

### SP8 Start Bilateral Interoperability Testing (for all waves)

01/10/14

---

SP 8 marks the start of the Bilateral Interoperability phase.

Plan reference ID 2011100

#### Eurosystem:

The Eurosystem confirms that Eurosystem Acceptance Test results have provided assurance that the quality required to start the User Testing is met. The Eurosystem confirms helpdesk is in place and problem management processes are operational. Documentation on testing processes has been delivered.

#### CSDs and CBs:

CSDs and CBs confirm their readiness for interoperability testing, including compliance of their adapted IT systems with the CASG Standards and other harmonisation initiatives. They have completed the training of staff involved in testing. They have communicated any identified potential showstoppers to the Eurosystem.

Test cases for acceptance have been communicated and agreed. The CSDs and CBs can now start the Bilateral Interoperability phase where they are going to execute the test cases for acceptance and the test cases required to get the certification. The starting date presented is the earliest starting date, since this is a bilateral phase, CSD and CB may decide to start this stage at a later date.

---

#### Checklist:

##### Description:

	<u>Del ID:</u>	<u>Owner:</u>	<u>Plan ID:</u>	<u>Date:</u>
<input type="checkbox"/> Interim verification of the List of Potential Show stopper from CSDs (dependencie		CSDs,CBs	644200	09/06/14
<input type="checkbox"/> Internal system adapted according to UDFS specifications by CSDs/CBs		CSDs,CBs	641150	30/06/14
<input type="checkbox"/> SP6 - Eurosystem Ready for User Testing			2009100	02/09/14
<input type="checkbox"/> [Deliverable] - User Testing Stage Report (Wave 2) V2.0 [Connectivity phase]	201	Eurosystem	840560	26/09/14
<input type="checkbox"/> [Deliverable] - User Testing Stage Report (Wave 1) V1.0 [Connectivity phase]	201	Eurosystem	646160	30/09/14
<input type="checkbox"/> [Deliverable] - User Testing Stage Report (Wave 3) V3.0 [Connectivity phase]	201	Eurosystem	2200600	30/09/14

# Currency Participation Agreement

## SCHEDULE 2 – ANNEX 9 – T2S list of Synchronisation points

---

### SP9.1 Start Multilateral Interoperability Testing (Wave 1)

29/12/14

---

SP 9.1 marks the start of the Multilateral Interoperability Phase for the CSDs and CBs of the wave 1.

[Plan reference ID](#) 2011200

#### Eurosystem:

The Eurosystem has monitored the CSD and CB activity during the Bilateral Interoperability and has confirmed the CSD and CB capability to cope with the required T2S knowledge before starting the Multilateral Interoperability. The Eurosystem has issued the certificates for CSDs having passed the Certification test case execution.

#### CSDs and CBs:

CSDs and CBs have completed the execution of the certification test cases and have been certified. They are now ready to start the multilateral interoperability test phases where they will continue to test T2S in collaboration with other CSDs and CBs. In this phase, the CSDs and CBs will also complete their acceptance testing.

---

#### Checklist:

##### Description:

	<u>Del ID:</u>	<u>Owner:</u>	<u>Plan ID:</u>	<u>Date:</u>
<input type="checkbox"/> Confirmation of the Timing and Composition of Migration Waves by Eurosystem		Eurosystem	1209150	08/10/12
<input type="checkbox"/> [Deliverable] - Registration Guide for Migration V1.0	74	Eurosystem	1222100	29/08/13
<input type="checkbox"/> [Deliverable] - Standard Migration Plan V1.0	26	Eurosystem	1232800	01/11/13
<input type="checkbox"/> Registration Guide for Migration filled in by CSDs/CBs (Wave 1)		CSDs,CBs	727100	03/09/14
<input type="checkbox"/> [Deliverable] - Migration Training Materials	110	Eurosystem	569200	01/12/14
<input type="checkbox"/> [Deliverable] - User Testing Stage Report (Wave 1) V1.1 Interoperability Bilateral	201	Eurosystem	714280	18/12/14
<input type="checkbox"/> [Deliverable] - Eurosystem T2S Certification (Wave 1)	37	Eurosystem	647960	29/12/14
<input type="checkbox"/> [Deliverable] - Eurosystem T2S Certification (Wave 1)	37	Eurosystem	647850	29/12/14

# Currency Participation Agreement

## SCHEDULE 2 – ANNEX 9 – T2S list of Synchronisation points

---

### SP9.2 Start Multilateral Interoperability Testing (Wave 2)

02/04/15

---

SP 9.2 marks the start of the Multilateral Interoperability Phase for the CSDs and CBs of the wave 2.

[Plan reference ID](#) 2011300

#### Eurosystem:

The Eurosystem has monitored the CSD and CB activity during the Bilateral Interoperability and has confirmed the CSD and CB capability to cope with the required T2S knowledge before starting the Multilateral Interoperability. The Eurosystem has issued the certificates for CSDs having passed the Certification test case execution.

#### CSDs and CBs:

CSDs and CBs have completed the execution of the certification test cases and have been certified. They are now ready to start the multilateral interoperability test phases where they will continue to test T2S in collaboration with other CSDs and CBs. In this phase, the CSDs and CBs will also complete their acceptance testing.

---

#### Checklist:

##### Description:

	<u>Del ID:</u>	<u>Owner:</u>	<u>Plan ID:</u>	<u>Date:</u>
<input type="checkbox"/> Registration Guide for Migration filled in by CSDs/CBs (Wave 2)		CSDs,CBs	917100	06/10/14
<input type="checkbox"/> [Deliverable] - User Testing Stage Report (Wave 2) V2.1 [Interoperability Bilateral	201	Eurosystem	914180	18/03/15
<input type="checkbox"/> [Deliverable] - Eurosystem T2S Certification (Wave 2)	37	Eurosystem	648250	01/04/15
<input type="checkbox"/> [Deliverable] - Eurosystem T2S Certification (Wave 2)	37	Eurosystem	648360	01/04/15



# Currency Participation Agreement

## SCHEDULE 2 – ANNEX 9 – T2S list of Synchronisation points

---

### SP9.3 Start Multilateral Interoperability Testing (Wave 3)

23/06/15

---

SP 9.3 marks the start of the Multilateral Interoperability Phase for the CSDs and CBs of the wave 3.

[Plan reference ID](#) 2011400

#### Eurosystem:

The Eurosystem has monitored the CSD and CB activity during the Bilateral Interoperability and has confirmed the CSD and CB capability to cope with the required T2S knowledge before starting the Multilateral Interoperability. The Eurosystem has issued the certificates for CSDs having passed the Certification test case execution.

#### CSDs and CBs:

CSDs and CBs have completed the execution of the certification test cases and have been certified. They are now ready to start the multilateral interoperability test phases where they will continue to test T2S in collaboration with other CSDs and CBs. In this phase, the CSDs and CBs will also complete their acceptance testing.

---

#### Checklist:

##### Description:

	<u>Del ID:</u>	<u>Owner:</u>	<u>Plan ID:</u>	<u>Date:</u>
<input type="checkbox"/> Registration Guide for Migration filled in by CSDs/CBs (Wave 3)		CSDs,CBs	2282500	17/04/15
<input type="checkbox"/> [Deliverable] - Eurosystem T2S Certification (Wave 3)	37	Eurosystem	648550	22/06/15
<input type="checkbox"/> [Deliverable] - Eurosystem T2S Certification (Wave 3)	37	Eurosystem	648650	22/06/15
<input type="checkbox"/> [Deliverable] - User Testing Stage Report (Wave 3) V3.1 Interoperability Bilateral	201	Eurosystem	2273080	23/06/15

# Currency Participation Agreement

## SCHEDULE 2 – ANNEX 9 – T2S list of Synchronisation points

---

### SP10.1 Start Community Testing (Wave 1)

04/03/15

---

SP 10.1 marks the start of Community Testing Phase.

Plan reference ID 2012100

#### Eurosystem:

Eurosystem confirms the necessary information for DCP/ DCAH certification and migration dress rehearsal has been provided. The Eurosystem is ready to initiate community testing.

#### CSDs and CBs:

CSD and CB Acceptance process has been finalized. CSDs and CBs have successfully completed interoperability tests and have proved that their adapted IT platforms interoperate correctly with T2S. CSDs and CBs confirm their internal operational readiness to enter this test phase, i.e. internal staff trained, required procedures are operational, and local operations are familiar with the operation of T2S. CSDs and CBs have trained their communities and agreed certification processes/approach with their respective DCPs. CSDs and CBs are ready to execute migration tests and dress rehearsals.

---

#### Checklist:

##### Description:

	<u>Del ID:</u>	<u>Owner:</u>	<u>Plan ID:</u>	<u>Date:</u>
<input type="checkbox"/> Confirmation that CB members are ready (Wave 1)		CBs	728300	04/02/15
<input type="checkbox"/> Confirmation that test cases and supporting data and processes are ready for Co		CSDs,CBs	728400	04/02/15
<input type="checkbox"/> Confirmation that CSD participants are ready (Wave 1)		CSDs	728200	04/02/15
<input type="checkbox"/> [Deliverable] - User Testing Stage Report (Wave 1) V1.2 [Interoperability Multilater	201	Eurosystem	723100	04/03/15

# Currency Participation Agreement

## SCHEDULE 2 – ANNEX 9 – T2S list of Synchronisation points

---

### SP10.2 Start Community Testing (Wave 2)

29/05/15

---

SP 10.2 marks the start of Community Testing Phase.

Plan reference ID 2012200

#### Eurosystem:

Eurosystem confirms the necessary information for DCP/ DCAH certification and migration dress rehearsal has been provided. The Eurosystem is ready to initiate community testing.

#### CSDs and CBs:

CSD and CB Acceptance process has been finalized. CSDs and CBs have successfully completed interoperability tests and have proved that their adapted IT platforms interoperate correctly with T2S. CSDs and CBs confirm their internal operational readiness to enter this test phase, i.e. internal staff trained, required procedures are operational, and local operations are familiar with the operation of T2S. CSDs and CBs have trained their communities and agreed certification processes/approach with their respective DCPs. CSDs and CBs are ready to execute migration tests and dress rehearsals.

---

#### Checklist:

##### Description:

	<u>Del ID:</u>	<u>Owner:</u>	<u>Plan ID:</u>	<u>Date:</u>
<input type="checkbox"/> SP10.1 - Start Community Testing (wave 1)			2012100	04/03/15
<input type="checkbox"/> Confirmation that CB members are ready (Wave 2)		CBs	918300	30/04/15
<input type="checkbox"/> Confirmation that test cases and supporting data and processes are ready for Co		CSDs,CBs	918400	30/04/15
<input type="checkbox"/> Confirmation that CSD participants are ready (Wave 2)		CSDs	918200	30/04/15
<input type="checkbox"/> [Deliverable] - User Testing Stage Report (Wave 2) V2.2 [Interoperability Multilate	201	Eurosystem	913100	29/05/15

# Currency Participation Agreement

## SCHEDULE 2 – ANNEX 9 – T2S list of Synchronisation points

---

### SP10.3 Start Community Testing (Wave 3)

09/11/15

---

SP 10.3 marks the start of Community Testing Phase.

Plan reference ID 2012300

#### Eurosystem:

Eurosystem confirms the necessary information for DCP/ DCAH certification and migration dress rehearsal has been provided. The Eurosystem is ready to initiate community testing.

#### CSDs and CBs:

CSD and CB Acceptance process has been finalized. CSDs and CBs have successfully completed interoperability tests and have proved that their adapted IT platforms interoperate correctly with T2S. CSDs and CBs confirm their internal operational readiness to enter this test phase, i.e. internal staff trained, required procedures are operational, and local operations are familiar with the operation of T2S. CSDs and CBs have trained their communities and agreed certification processes/approach with their respective DCPs. CSDs and CBs are ready to execute migration tests and dress rehearsals.

---

#### Checklist:

##### Description:

	<u>Del ID:</u>	<u>Owner:</u>	<u>Plan ID:</u>	<u>Date:</u>
<input type="checkbox"/> SP10.1 - Start Community Testing (wave 1)			2012100	04/03/15
<input type="checkbox"/> Confirmation that test cases and supporting data and processes are ready for Co		CSDs	2283000	12/10/15
<input type="checkbox"/> Confirmation that CB members are ready (wave 3)		CBs	2282000	12/10/15
<input type="checkbox"/> Confirmation that CSDs participants are ready (wave 3)		CSDs	2281000	12/10/15
<input type="checkbox"/> [Deliverable] - User Testing Stage Report(Wave 3) V3.2 [Interoperability Multilater	201	Eurosystem	2275000	30/10/15

# Currency Participation Agreement

## SCHEDULE 2 – ANNEX 9 – T2S list of Synchronisation points

---

### SP11.1 Start Business Day Testing (Wave 1)

18/05/15

---

SP 11.1 marks the start of Business Day Testing Phase

Plan reference ID 2012400

#### Eurosystem:

The Eurosystem confirms the team readiness to support the simulation of several consecutive business days of T2S operation. These business operations days will be executed after a migration rehearsal for the respective CSD and CB migration wave. The Eurosystem has provided the detailed migration playbook (Script) for the migration WE execution. DCP/DCAH Certification process has been completed.

#### CSDs and CBs:

CSDs and CBs learned from the Community testing phase and have adapted their operational processes accordingly.

---

#### Checklist:

##### Description:

	<u>Del ID:</u>	<u>Owner:</u>	<u>Plan ID:</u>	<u>Date:</u>
<input type="checkbox"/> [Deliverable] - Manual of Operational Procedures (MOP) V1.0 for Business Day T	10	Eurosystem	1140100	24/04/14
<input type="checkbox"/> [Deliverable] - Operational Training Materials	110	Eurosystem	568800	03/06/14
<input type="checkbox"/> [Deliverable] - Certification report for DCPs (Wave 1)	46	Eurosystem	789800	15/04/15
<input type="checkbox"/> [Deliverable] - Certification report for DCAH (Wave 1)	46	Eurosystem	792000	15/04/15
<input type="checkbox"/> [Deliverable] - User Testing Stage Report (Wave 1) V1.3 [Community phase]	201	Eurosystem	789400	14/05/15

# Currency Participation Agreement

## SCHEDULE 2 – ANNEX 9 – T2S list of Synchronisation points

---

### SP11.2 Start Business Day Testing (Wave 2)

09/11/15

---

SP 11.2 marks the start of Business Day Testing Phase

Plan reference ID 2012500

#### Eurosystem:

The Eurosystem confirms the team readiness to support the simulation of several consecutive business days of T2S operation. These business operations days will be executed after a migration rehearsal for the respective CSD and CB migration wave. The Eurosystem has provided the detailed migration playbook (Script) for the migration WE execution. DCP/DCAH Certification process has been completed.

#### CSDs and CBs:

CSDs and CBs learned from the Community testing phase and have adapted their operational processes accordingly.

---

#### Checklist:

##### Description:

	<u>Del ID:</u>	<u>Owner:</u>	<u>Plan ID:</u>	<u>Date:</u>
<input type="checkbox"/> SP10.1 - Start Community Testing (wave 1)			2012100	04/03/15
<input type="checkbox"/> [Deliverable] - Certification report for DCAH (Wave 2)	46	Eurosystem	981000	07/10/15
<input type="checkbox"/> [Deliverable] - Certification report for DCPs (Wave 2)	46	Eurosystem	979700	07/10/15
<input type="checkbox"/> [Deliverable] - User Testing Stage Report (Wave 2) V2.3 [Community phase]	201	Eurosystem	979300	04/11/15

# Currency Participation Agreement

## SCHEDULE 2 – ANNEX 9 – T2S list of Synchronisation points

---

### SP11.3 Start Business Day Testing (Wave 3)

27/04/16

---

SP 11.3 marks the start of Business Day Testing Phase

Plan reference ID 2012600

#### Eurosystem:

The Eurosystem confirms the team readiness to support the simulation of several consecutive business days of T2S operation. These business operations days will be executed after a migration rehearsal for the respective CSD and CB migration wave. The Eurosystem has provided the detailed migration playbook (Script) for the migration WE execution. DCP/DCAH Certification process has been completed.

#### CSDs and CBs:

CSDs and CBs learned from the Community testing phase and have adapted their operational processes accordingly.

---

#### Checklist:

##### Description:

	<u>Del ID:</u>	<u>Owner:</u>	<u>Plan ID:</u>	<u>Date:</u>
<input type="checkbox"/> SP10.1 - Start Community Testing (wave 1)			2012100	04/03/15
<input type="checkbox"/> [Deliverable] - Certification report for DCAH (Wave 3)	46	Eurosystem	2346700	18/03/16
<input type="checkbox"/> [Deliverable] - Certification report for DCPs (Wave 3)	46	Eurosystem	2346300	18/03/16
<input type="checkbox"/> [Deliverable] - User Testing Stage Report (Wave 3) V3.3 [Community phase]	201	Eurosystem	2345100	27/04/16

# Currency Participation Agreement

## SCHEDULE 2 – ANNEX 9 – T2S list of Synchronisation points

---

### SP12.1 End of User Testing Execution Phase (Wave 1)

15/06/15

---

SP 12.1 marks the end of User Testing by CSDs and CBs.

Plan reference ID 2013100

#### Eurosystem:

The Eurosystem confirms compliance of Eurosystem, CSDs and CBs as well as directly connected parties, with exit criteria for the user test. The Eurosystem provides a test report on the results of the user test that documents remaining defects and a plan for their resolution.

#### CSDs and CBs:

The CSDs and CBs confirm the Eurosystem Final User Test Report regarding the remaining defects and the priorities for their resolution. CSDs and CBs assess their operational readiness status and provide a clear status on the readiness to go-live with T2S to their respective community. CSDs have assessed whether their DCPs fulfil any specific requirements for local processing.

---

#### Checklist:

##### Description:

Del ID: Owner: Plan ID: Date:

<input type="checkbox"/> [Deliverable] - User Testing Stage Report (Wave 1) V1.4 [Business day phase]	201	Eurosystem	832300	12/06/15
---	-----	------------	--------	----------



# Currency Participation Agreement

## SCHEDULE 2 – ANNEX 9 – T2S list of Synchronisation points

---

### SP12.2 End of User Testing Execution Phase (Wave 2)

18/01/16

---

SP 12.2 marks the end of User Testing by CSDs and CBs.

[Plan reference ID](#) 2013200

#### Eurosystem:

The Eurosystem confirms compliance of Eurosystem, CSDs and CBs as well as directly connected parties, with exit criteria for the user test. The Eurosystem provides a test report on the results of the user test that documents remaining defects and a plan for their resolution.

#### CSDs and CBs:

The CSDs and CBs confirm the Eurosystem Final User Test Report regarding the remaining defects and the priorities for their resolution. CSDs and CBs assess their operational readiness status and provide a clear status on the readiness to go-live with T2S to their respective community. CSDs have assessed whether their DCPs fulfil any specific requirements for local processing.

---

#### Checklist:

##### Description:

Del ID: Owner: Plan ID: Date:

<input type="checkbox"/> [Deliverable] - User Testing Stage Report (Wave 2) V2.4 [Business day phase]	201	Eurosystem	1022300	11/01/16
---	-----	------------	---------	----------

# Currency Participation Agreement

## SCHEDULE 2 – ANNEX 9 – T2S list of Synchronisation points

---

### SP12.3 End of User Testing Execution Phase (Wave 3)

29/06/16

---

SP 12.3 marks the end of User Testing by CSDs and CBs.

Plan reference ID 2013300

#### Eurosystem:

The Eurosystem confirms compliance of Eurosystem, CSDs and CBs as well as directly connected parties, with exit criteria for the user test. The Eurosystem provides a test report on the results of the user test that documents remaining defects and a plan for their resolution.

#### CSDs and CBs:

The CSDs and CBs confirm the Eurosystem Final User Test Report regarding the remaining defects and the priorities for their resolution. CSDs and CBs assess their operational readiness status and provide a clear status on the readiness to go-live with T2S to their respective community. CSDs have assessed whether their DCPs fulfil any specific requirements for local processing.

---

#### Checklist:

##### Description:

Del ID: Owner: Plan ID: Date:

<input type="checkbox"/> [Deliverable] - User Testing Stage Report (Wave 3) V3.4 [Business day phase]	201	Eurosystem	2390200	22/06/16
---	-----	------------	---------	----------

# Currency Participation Agreement

## SCHEDULE 2 – ANNEX 9 – T2S list of Synchronisation points

---

### SP13 Eurosystem ready for Production

01/12/14

---

SP13 marks the confirmation of Eurosystem to the CSDs and CBs that the T2S production environment is ready.

Plan reference ID 2014100

#### Eurosystem:

The Eurosystem confirms to the CSDs and CBs that the production environment is ready to connect. The environment is ready for the creation of the initial production set-up of system entities, users, access rights and other configuration data, to be performed according to the information received in the registration guides.

#### CSDs and CBs:

CSDs and CBs have submitted their registration guides for migration and have verified that there are no showstoppers for their connectivity to the T2S production environment.

---

#### Checklist:

##### Description:

	<u>Del ID:</u>	<u>Owner:</u>	<u>Plan ID:</u>	<u>Date:</u>
<input type="checkbox"/> Final Network Acceptance Tests (PROD)		Eurosystem	1066200	11/10/13
<input type="checkbox"/> [Deliverable] - Non Functional Testing Report	141	Eurosystem	386100	28/02/14
<input type="checkbox"/> T2S helpdesk is operational and contact details have been communicated to all re		Eurosystem	1258200	17/11/14
<input type="checkbox"/> Network ready for Production		Eurosystem	387100	01/12/14

# Currency Participation Agreement

## SCHEDULE 2 – ANNEX 9 – T2S list of Synchronisation points

### SP14.1 Ready to connect to Production (Wave 1)

05/02/15

SP 14.1 marks the confirmation from the CSDs and CBs that they can technically connect to the T2S production environment.

Plan reference ID 2015100

#### Eurosystem:

The Eurosystem delivers the connectivity guide for the T2S production environment and the technical helpdesk is ready to support CSDs and CBs connectivity activities to the production environment.

#### CSDs and CBs:

CSDs and CBs have implemented the required configurations to connect to the production environment and can connect successfully to the T2S production environment.

#### Checklist:

##### Description:

	<u>Del ID:</u>	<u>Owner:</u>	<u>Plan ID:</u>	<u>Date:</u>
<input type="checkbox"/> [Deliverable] - Data Migration Tools specifications and related procedures V1.0	73	Eurosystem	1206100	31/10/12
<input type="checkbox"/> [Deliverable] - Registration Guide for Migration V1.0	74	Eurosystem	1222100	29/08/13
<input type="checkbox"/> [Deliverable] - Connectivity Guide for VAN and Direct connectivity V2.0	8	Eurosystem	1043100	02/01/14
<input type="checkbox"/> T2S helpdesk is operational and contact details have been communicated to all re		Eurosystem	1258200	17/11/14
<input type="checkbox"/> SP13 - Eurosystem ready for Production			2014100	01/12/14
<input type="checkbox"/> Registration Form filled in (wave 1 + CSDs/CBs with Common Static Data)		CSDs,CBs	1247100	12/12/14
<input type="checkbox"/> [Deliverable] - CSD's T2S Compliance Confirmation (Wave 1)	36	CSDs,CBs	647360	29/12/14
<input type="checkbox"/> [Deliverable] - Proof of Eligibility to Participate in T2S (Wave 1)	425	CSDs	625600	19/01/15
<input type="checkbox"/> Input Registration Data completed		Eurosystem	1252150	29/01/15
<input type="checkbox"/> Completed network registration by CBs (wave 1)		CBs	1255300	05/02/15
<input type="checkbox"/> Completed network registration by CSDs (wave 1)		CSDs	1255200	05/02/15
<input type="checkbox"/> PROD environment available for users		Eurosystem	1256100	05/02/15

# Currency Participation Agreement

## SCHEDULE 2 – ANNEX 9 – T2S list of Synchronisation points

---

### SP14.2 Ready to connect to Production (Wave 2)

02/10/15

---

SP 14.2 marks the confirmation from the CSDs and CBs that they can technically connect to the T2S production environment.

Plan reference ID 2015200

#### Eurosystem:

The Eurosystem delivers the connectivity guide for the T2S production environment and the technical helpdesk is ready to support CSDs and CBs connectivity activities to the production environment.

#### CSDs and CBs:

CSDs and CBs have implemented the required configurations to connect to the production environment and can connect successfully to the T2S production environment.

---

#### Checklist:

##### Description:

	<u>Del ID:</u>	<u>Owner:</u>	<u>Plan ID:</u>	<u>Date:</u>
<input type="checkbox"/> SP14.1 - Ready to connect to Production (wave 1)			2015100	05/02/15
<input type="checkbox"/> [Deliverable] - CSD's T2S Compliance Confirmation (Wave 2)	36	CSDs,CBs	647460	02/04/15
<input type="checkbox"/> Registration Form filled in (CSDs/CBs) (wave 2)		CSDs,CBs	1281500	11/09/15
<input type="checkbox"/> [Deliverable] - Proof of Eligibility to Participate in T2S (Wave 2)	425	CSDs	626700	15/09/15
<input type="checkbox"/> T2S helpdesk is operational and contact details have been communicated to all re		Eurosystem	1283700	21/09/15
<input type="checkbox"/> Input Registration Data completed (wave 2)		Eurosystem	1262100	02/10/15
<input type="checkbox"/> Completed network registration by CSDs (wave 2)		CSDs	1283350	02/10/15
<input type="checkbox"/> Completed network registration by CBs (wave 2)		CBs	1283380	02/10/15

# Currency Participation Agreement

## SCHEDULE 2 – ANNEX 9 – T2S list of Synchronisation points

---

### SP14.3 Ready to connect to Production (Wave 3)

22/03/16

---

SP 14.3 marks the confirmation from the CSDs and CBs that they can technically connect to the T2S production environment.

Plan reference ID 2015300

#### Eurosystem:

The Eurosystem delivers the connectivity guide for the T2S production environment and the technical helpdesk is ready to support CSDs and CBs connectivity activities to the production environment.

#### CSDs and CBs:

CSDs and CBs have implemented the required configurations to connect to the production environment and can connect successfully to the T2S production environment.

---

#### Checklist:

##### Description:

	<u>Del ID:</u>	<u>Owner:</u>	<u>Plan ID:</u>	<u>Date:</u>
<input type="checkbox"/> SP14.1 - Ready to connect to Production (wave 1)			2015100	05/02/15
<input type="checkbox"/> [Deliverable] - CSD's T2S Compliance Confirmation (Wave 3)	36	CSDs,CBs	647560	02/04/15
<input type="checkbox"/> [Deliverable] - Proof of Eligibility to Participate in T2S (Wave 3)	425	CSDs	628000	03/03/16
<input type="checkbox"/> Registration Form filled in (CSDs/CBs) (wave 3)		CSDs,CBs	1293600	04/03/16
<input type="checkbox"/> T2S helpdesk is operational and contact details have been communicated to all re		Eurosystem	1294800	09/03/16
<input type="checkbox"/> Completed network registration by CSDs (wave 3)		CSDs	1294200	22/03/16
<input type="checkbox"/> Input registration data completed (wave 3)		Eurosystem	1261050	22/03/16
<input type="checkbox"/> Completed network registration by CBs (wave 3)		CBs	1294350	22/03/16

# Currency Participation Agreement

## SCHEDULE 2 – ANNEX 9 – T2S list of Synchronisation points

---

### SP15.1 Ready to upload static data (Wave 1)

19/03/15

---

SP 15.1 marks the start of the upload of the required static and configuration data for the migration to T2S.

Plan reference ID 2016100

#### Eurosystem:

The Eurosystem has tested the migration utilities for static and configuration data successfully with CSDs and CBs during User Testing.

#### CSDs and CBs:

CSDs and CBs have established the processes to ensure the update and synchronisation of static and configuration data. They have established the required control mechanisms for reconciliation. They have performed a quality assurance of the static data that needs to be loaded in T2S on their respective operational systems.

---

#### Checklist:

##### Description:

	<u>Del ID:</u>	<u>Owner:</u>	<u>Plan ID:</u>	<u>Date:</u>
<input type="checkbox"/> T2S System Configuration parameters finalised		Eurosystem	1270400	29/01/15
<input type="checkbox"/> SP14.1 - Ready to connect to Production (wave 1)			2015100	05/02/15
<input type="checkbox"/> Relevant Static Data ready by CBs (wave1)		CBs	1271300	05/03/15
<input type="checkbox"/> Relevant Static Data ready by CSDs (wave1)		CSDs	1271200	05/03/15
<input type="checkbox"/> Successful connectivity tests CSD (wave 1)		CSDs	1263100	12/03/15
<input type="checkbox"/> Successful connectivity tests CB (wave 1)		CBs	1255400	12/03/15

# Currency Participation Agreement

## SCHEDULE 2 – ANNEX 9 – T2S list of Synchronisation points

---

### SP15.2 Ready to upload static data (Wave 2)

06/11/15

---

SP 15.2 marks the start of the upload of the required static and configuration data for the migration to T2S.

Plan reference ID 2016200

#### Eurosystem:

The Eurosystem has tested the migration utilities for static and configuration data successfully with CSDs and CBs during User Testing.

#### CSDs and CBs:

CSDs and CBs have established the processes to ensure the update and synchronisation of static and configuration data. They have established the required control mechanisms for reconciliation. They have performed a quality assurance of the static data that needs to be loaded in T2S on their respective operational systems.

---

#### Checklist:

##### Description:

	<u>Del ID:</u>	<u>Owner:</u>	<u>Plan ID:</u>	<u>Date:</u>
<input type="checkbox"/> SP15.1 - Ready to upload Static Data (wave 1)			2016100	19/03/15
<input type="checkbox"/> Relevant Static Data ready CSD (wave 2)		CSDs	1284200	09/10/15
<input type="checkbox"/> Relevant Static Data ready CB (wave 2)		CBs	1284300	09/10/15
<input type="checkbox"/> Successful connectivity tests CB (wave 2)		CBs	1283390	30/10/15
<input type="checkbox"/> Successful connectivity tests CSD (wave 2)		CSDs	1283370	30/10/15



# Currency Participation Agreement

## SCHEDULE 2 – ANNEX 9 – T2S list of Synchronisation points

---

### SP15.3 Ready to upload static data (Wave 3)

22/04/16

---

SP 15.3 marks the start of the upload of the required static and configuration data for the migration to T2S.

Plan reference ID 2016300

#### Eurosystem:

The Eurosystem has tested the migration utilities for static and configuration data successfully with CSDs and CBs during User Testing.

#### CSDs and CBs:

CSDs and CBs have established the processes to ensure the update and synchronisation of static and configuration data. They have established the required control mechanisms for reconciliation. They have performed a quality assurance of the static data that needs to be loaded in T2S on their respective operational systems.

---

#### Checklist:

##### Description:

	<u>Del ID:</u>	<u>Owner:</u>	<u>Plan ID:</u>	<u>Date:</u>
<input type="checkbox"/> SP15.1 - Ready to upload Static Data (wave 1)			2016100	19/03/15
<input type="checkbox"/> Relevant Static Data ready CSD (wave 3)		CSDs	1297200	27/03/16
<input type="checkbox"/> Relevant Static Data ready CB (wave 3)		CBs	1297300	27/03/16
<input type="checkbox"/> Successful connectivity tests CB (wave 3)		CBs	1294370	15/04/16
<input type="checkbox"/> Successful connectivity tests CSD (wave 3)		CSDs	1294300	15/04/16

# Currency Participation Agreement

## SCHEDULE 2 – ANNEX 9 – T2S list of Synchronisation points

---

### SP16.1 Ready for T2S Go-Live (Wave 1)

19/06/15

---

SP 16.1 marks the latest checkpoint prior to the migration WE execution.

[Plan reference ID](#) 2017100

#### Eurosystem:

The Eurosystem confirms that the production environment is ready for the migration of CSDs and CBs to T2S. The Eurosystem has defined and agreed the organisation and timeline of the migration weekend with the relevant stakeholders. The Eurosystem has established the necessary control mechanisms and decision points to ensure a successful execution of the migration procedures or to allow a rollback in contingency situations. The Eurosystem in conjunction with CSDs and CBS has defined the roles and responsibilities of each stakeholder. It has established a formal communication plan and escalation process.

#### CSDs and CBs:

CSDs and CBs confirm that the final migration dress rehearsal has been successful. They confirm to follow the agreed procedures and processes for the migration weekend. CSDs and CBs have ensured staff availability for the migration weekend. CSDs and CBs have established the necessary internal controls on the migration process to ensure the completeness and the correctness of their migration.

---

#### Checklist:

##### Description:

	<u>Del ID:</u>	<u>Owner:</u>	<u>Plan ID:</u>	<u>Date:</u>
<input type="checkbox"/> [Deliverable] - Detailed Migration Weekend Script V1.0 Wave 1	27	Eurosystem	1235400	28/11/14
<input type="checkbox"/> SP15.1 - Ready to upload Static Data (wave 1)			2016100	19/03/15
<input type="checkbox"/> [Deliverable] - Risk Analysis on T2S Compliance with T2S Information Security pol	116	Eurosystem	1108100	22/05/15
<input type="checkbox"/> Final verification of the list of showstoppers wave 1 (dependencies with local regul		CSDs,CBs	1272200	22/05/15
<input type="checkbox"/> External communication has been rolled-out (wave 1)		CSDs,CBs	1277400	05/06/15
<input type="checkbox"/> Confirmation that internal control mechanisms are in place (wave 1)		CSDs,CBs	1277300	05/06/15
<input type="checkbox"/> Confirmation that migration script has been integrated in internal plans (wave 1)		CSDs,CBs	1277000	12/06/15
<input type="checkbox"/> Internal staff trained for change-over Weekend and operations (wave 1)		CSDs,CBs	1277200	18/06/15

# Currency Participation Agreement

## SCHEDULE 2 – ANNEX 9 – T2S list of Synchronisation points

---

### SP16.2 Ready for T2S Migration Wave 2

29/01/16

---

SP 16.2 marks the latest checkpoint prior to the migration WE execution.

Plan reference ID 2017200

#### Eurosystem:

The Eurosystem confirms that the production environment is ready for the migration of CSDs and CBs to T2S. The Eurosystem has defined and agreed the organisation and timeline of the migration weekend with the relevant stakeholders. The Eurosystem has established the necessary control mechanisms and decision points to ensure a successful execution of the migration procedures or to allow a rollback in contingency situations. The Eurosystem in conjunction with CSDs and CBS has defined the roles and responsibilities of each stakeholder. It has established a formal communication plan and escalation process.

#### CSDs and CBs:

CSDs and CBs confirm that the final migration dress rehearsal has been successful. They confirm to follow the agreed procedures and processes for the migration weekend. CSDs and CBs have ensured staff availability for the migration weekend. CSDs and CBs have established the necessary internal controls on the migration process to ensure the completeness and the correctness of their migration.

---

#### Checklist:

##### Description:

	<u>Del ID:</u>	<u>Owner:</u>	<u>Plan ID:</u>	<u>Date:</u>
<input type="checkbox"/> Final verification of the list of showstoppers wave 1 (dependencies with local regul		CSDs,CBs	1272200	22/05/15
<input type="checkbox"/> [Deliverable] - Risk Analysis on T2S Compliance with T2S Information Security pol	116	Eurosystem	1108100	22/05/15
<input type="checkbox"/> SP14.2 - Ready to connect to Production (wave 2)			2015200	02/10/15
<input type="checkbox"/> SP15.2 - Ready to upload Static Data (wave 2)			2016200	06/11/15
<input type="checkbox"/> [Deliverable] - Detailed Migration Weekend Script V2.2 Wave 2	27	Eurosystem	1237300	09/11/15
<input type="checkbox"/> External communication has been rolled-out (Wave 2)		CSDs,CBs	1287500	15/01/16
<input type="checkbox"/> Confirmation that internal control mechanisms are in place (Wave 2)		CSDs,CBs	1287400	15/01/16
<input type="checkbox"/> Confirmation that migration script has been integrated in internal plans (Wave 2)		CSDs,CBs	1287200	22/01/16
<input type="checkbox"/> Internal staff trained for change-over Weekend and operations (Wave 2)		CSDs,CBs	1287300	28/01/16

# Currency Participation Agreement

## SCHEDULE 2 – ANNEX 9 – T2S list of Synchronisation points

### SP16.3 Ready for T2S Migration Wave 3

15/07/16

SP 16.3 marks the latest checkpoint prior to the migration WE execution.

Plan reference ID 2017300

#### Eurosystem:

The Eurosystem confirms that the production environment is ready for the migration of CSDs and CBs to T2S. The Eurosystem has defined and agreed the organisation and timeline of the migration weekend with the relevant stakeholders. The Eurosystem has established the necessary control mechanisms and decision points to ensure a successful execution of the migration procedures or to allow a rollback in contingency situations. The Eurosystem in conjunction with CSDs and CBs has defined the roles and responsibilities of each stakeholder. It has established a formal communication plan and escalation process.

#### CSDs and CBs:

CSDs and CBs confirm that the final migration dress rehearsal has been successful. They confirm to follow the agreed procedures and processes for the migration weekend. CSDs and CBs have ensured staff availability for the migration weekend. CSDs and CBs have established the necessary internal controls on the migration process to ensure the completeness and the correctness of their migration.

#### Checklist:

##### Description:

	<u>Del ID:</u>	<u>Owner:</u>	<u>Plan ID:</u>	<u>Date:</u>
<input type="checkbox"/> Final verification of the list of showstoppers wave 1 (dependencies with local regul		CSDs,CBs	1272200	22/05/15
<input type="checkbox"/> [Deliverable] - Risk Analysis on T2S Compliance with T2S Information Security pol	116	Eurosystem	1108100	22/05/15
<input type="checkbox"/> [Deliverable] - Detailed Migration Weekend Script V3.2 Wave 3	27	Eurosystem	1238200	12/04/16
<input type="checkbox"/> SP15.3 - Ready to upload Static Data (wave 3)			2016300	22/04/16
<input type="checkbox"/> External communication has been rolled-out (Wave 3)		CSDs,CBs	1299600	01/07/16
<input type="checkbox"/> Confirmation that internal control mechanisms are in place (Wave 3)		CSDs,CBs	1299500	01/07/16
<input type="checkbox"/> Confirmation that migration script has been integrated in internal plans (Wave 3)		CSDs,CBs	1299300	08/07/16
<input type="checkbox"/> Internal staff trained for change-over Weekend and operations (Wave 3)		CSDs,CBs	1299400	14/07/16

# Currency Participation Agreement

## SCHEDULE 2 – ANNEX 9 – T2S list of Synchronisation points

---

### SP17 Closing T2S Programme

10/10/16

---

SP 17 marks the end of the T2S Programme.

Plan reference ID 2018300

#### Eurosystem:

The Eurosystem confirms that the production environment is ready for the migration of CSDs and CBs to T2S. The Eurosystem has defined and agreed the organisation and timeline of the migration weekend with the relevant stakeholders. The Eurosystem has established the necessary control mechanisms and decision points to ensure a successful execution of the migration procedures or to allow a rollback in contingency situations. The Eurosystem in conjunction with CSDs and CBs has defined the roles and responsibilities of each stakeholder. It has established a formal communication plan and escalation process.

#### CSDs and CBs:

All contracting CSDs and CBs are operational on T2S. They have identified any major pending issues and have communicated them to the Eurosystem for investigation and resolution.

---

#### Checklist:

##### Description:

	<u>Del ID:</u>	<u>Owner:</u>	<u>Plan ID:</u>	<u>Date:</u>
<input type="checkbox"/> [Deliverable] - End of Migration Report (Wave 1)	550	Eurosystem	835100	27/07/15
<input type="checkbox"/> [Deliverable] - End of Migration Report (Wave 2)	550	Eurosystem	1025100	07/03/16
<input type="checkbox"/> [Deliverable] - End of Migration Report (Wave 3)	550	Eurosystem	2394000	22/08/16

## CURRENCY PARTICIPATION AGREEMENT

### SCHEDULE 2 – ANNEX 10

#### T2S LIST OF MILESTONES ON THE CRITICAL PATH

***Disclaimer:***

Planning is an ongoing process and Annexes with planning elements are subject to change during the lifetime of a project. Planning workshops with CSDs and CBs will continue to agree on the planning for Connectivity, User Testing and Migration. Subsequent plan updates follow the process, documented in the Schedule 2, Section 7.

Annexes 2, 3, 4, 7, 8, 9 and 10 document the planning status as at 7 Nov. 2011.

## Currency Participation Agreement

### Schedule 2 – Annex 10 – T2S list of Milestones on the critical path

---

<b>ID Number*</b>	<b>Milestone Description</b>	<b>Date**</b>	<b>Responsible for delivery</b>
172200	WS - Delivery IDFS V0.85 to the Development Coordination	15/02/2011***	Eurosystem
124150	Final Validation Pillar II by the SGMS	04/03/2011***	SGMS
134150	Final Validation Pillar III by the SGMS	01/07/2011***	SGMS
211100	[Deliverable] - UDFS v1.2	31/10/2011***	Eurosystem
345101	Development Process - M1 - Technical Readiness for integration	30/09/2010***	Eurosystem
351130	Development Process - M2 - UDFS/IDFS stabilised and integrated in the development process iterations	01/04/2011***	Eurosystem
353130	Development process - M3 – Interfaces specifications frozen (UDFS/GUI): iteration 5 technically integrated and tested	31/10/2011***	Eurosystem
354130	Development Process - M4 - Start of 4CB IAC	02/04/2012	Eurosystem
355140	Development process – M5 – Technical stability	28/09/2012	Eurosystem
361101	Development process – M6 – Functional stability	29/03/2013	Eurosystem
339200	Development process – M7 – 4CB Internal Acceptance check point – Progress status	30/09/2013	Eurosystem
378101	Start Execution Infrastructure test	30/04/2013	Eurosystem
386100	[Deliverable] - Outcome of the Non Functional Testing	28/02/2014	Eurosystem
493160	Go-no go decision for the start of the User Testing	15/09/2014	Eurosystem

## Currency Participation Agreement

### Schedule 2 – Annex 10 – T2S list of Milestones on the critical path

<b>ID Number*</b>	<b>Milestone Description</b>	<b>Date**</b>	<b>Responsible for delivery</b>
580150	CSDs and CBs training session finalised	06/05/2015	Eurosystem, CSDs, CBs
634200	UT environment ready	18/06/2014	Eurosystem
124410	Start preparation of Migration Weekend (wave 1)	01/12/2014	Eurosystem
387100	Network ready for Production	01/12/2014	Eurosystem
1246100	Prod environment availability for 4CB teams	01/12/2014	Eurosystem
1247100	Registration Form filled in (wave 1 + CSDs/CBs with common static data)	12/12/2014	CSDs
1263100	Successful connectivity tests CSD (wave 1 + CSDs with common static data)	12/03/2015	CSDs
1255400	Successful connectivity tests CB (wave 1 + CBs with common static data)	12/03/2015	CBs
1279100	Wave 1 Start Operations in T2S	22/06/2015	Eurosystem, CSDs, CBs
1281200	Start preparation of Migration Weekend (wave 2)	17/08/2015	Eurosystem
1281500	Registration Form filled in (CSDs/CBs) (wave 2)	11/09/2015	CSDs
1283370	Successful connectivity tests CSD (wave 2 + CSDs with common static data)	30/10/2015	CSDs
1283390	Successful connectivity tests CB (wave 2 + CBs with common static data)	30/10/2015	CBs
1291100	Wave 2 Start Operations in T2S	01/02/2016	Eurosystem, CSDs, CBs
1293300	Start preparation of Migration Weekend (wave 3)	08/02/2016	Eurosystem



## Currency Participation Agreement

### Schedule 2 – Annex 10 – T2S list of Milestones on the critical path

<b>ID Number*</b>	<b>Milestone Description</b>	<b>Date**</b>	<b>Responsible for delivery</b>
1293600	Registration Form filled in (CSDs/CBs) (wave 3)	04/03/2016	CSDs
1294300	Successful connectivity tests CSD (wave 3 + CSDs with common static data)	15/04/2016	CSDs
1294370	Successful connectivity tests CB (wave 3 + CBs with common static data)	15/04/2016	CBs
1304100	Wave 3 Start Operations in T2S	18/07/2016	Eurosystem, CSDs, CBs
2006100	SP1 - Start Feasibility	20/12/2011	Eurosystem
2007100	SP2 - Feasibility Confirmation by CSd/CB	10/08/2012	CSDs, CBs
2009200	SP5 - Eurosystem ready for EAT	30/12/2013	Eurosystem
2009100	SP6 - Eurosystem Ready for User Testing	02/09/2014	Eurosystem
2010100	SP7 - Start Connectivity Test	07/07/2014	Eurosystem, CSDs, CBs
2011100	SP8 - Start Interoperability Bilateral Test	01/10/2014	Eurosystem, CSDs, CBs
2013100	SP12.1 - End of Testing (wave 1)	15/06/2015	Eurosystem, CSDs, CBs
2013200	SP12.2 - End of Testing (wave 2)	18/01/2016	Eurosystem, CSDs, CBs
2013300	SP12.3 - End of Testing (wave 3)	29/06/2016	Eurosystem, CSDs, CBs
2014100	SP13.1 - Eurosystem ready for Production (wave 1)	01/12/2014	CSDs, CBs
2014200	SP13.2 - Eurosystem ready for Production (wave 2)	11/09/2015	CSDs, CBs

## Currency Participation Agreement

### Schedule 2 – Annex 10 – T2S list of Milestones on the critical path

---

<b>ID Number*</b>	<b>Milestone Description</b>	<b>Date**</b>	<b>Responsible for delivery</b>
2014300	SP13.3 - Eurosystem ready for Production (wave 3)	04/03/2016	CSDs, CBs
2015100	SP14.1 - Ready to connect to Production Environment (wave 1)	05/02/2015	Eurosystem
2015200	SP14.2 - Ready to connect to Production Environment (wave 2)	02/10/2015	Eurosystem
2015300	SP14.3 - Ready to connect to Production Environment (wave 3)	22/03/2016	Eurosystem
2016100	SP15.1 - Ready to upload Static Data (wave 1)	19/03/2015	Eurosystem, CSDs, CBs
2016200	SP15.2 - Ready to upload Static Data (wave 2)	06/11/2015	Eurosystem, CSDs, CBs
2016300	SP15.3 - Ready to upload Static Data (wave 3)	22/04/2016	Eurosystem, CSDs, CBs
2017100	SP16.1 - Ready for Migration Weekend and Start Operations (wave 1)	19/06/2015	Eurosystem, CSDs, CBs
2017200	SP16.2 - Ready for Migration Weekend and Start Operations (wave 2)	29/01/2016	Eurosystem, CSDs, CBs
2017300	SP16.3 - Ready for Migration Weekend and Start Operations (wave 3)	15/07/2016	Eurosystem, CSDs, CBs
2017400	SP16.5 - Ready for Contingency Migration Weekend	27/01/2017	Eurosystem, CSDs, CBs

\*Link with MS Project Plan

\*\* The reference for the dates is the T2S Programme Plan

\*\*\* Milestones before the signature of FA, only for information

# **CURRENCY PARTICIPATION AGREEMENT**

## **SCHEDULE 3 USER TESTING**

# Currency Participation Agreement

## Schedule 3 – User Testing

---

### Table of contents

<b>1</b>	<b>Introduction .....</b>	<b>1</b>
1.1	Context.....	1
1.2	Structure of Schedule.....	1
<b>2</b>	<b>Scope and Objectives .....</b>	<b>2</b>
2.1	Scope .....	2
2.2	Objectives .....	2
<b>3</b>	<b>General Responsibilities of the Contracting Parties.....</b>	<b>3</b>
3.1	General responsibilities of the Eurosystem.....	3
3.2	General responsibilities of the Connected NCB.....	4
3.3	General responsibilities of the PMG Substructure .....	5
3.4	General responsibility related to Monitoring Client Readiness.....	6
<b>4</b>	<b>User Testing Preparation Phase .....</b>	<b>7</b>
<b>5</b>	<b>User Testing Execution Phase.....</b>	<b>9</b>
5.1	Testing Stage Organisation .....	9
5.2	Connectivity Testing Stage .....	10
5.2.1	Description .....	10
5.2.2	Responsibilities.....	10
5.2.3	Entry Criteria.....	11
5.2.4	Exit Criteria .....	11
5.3	NCBs' Acceptance Testing Stage.....	11
5.3.1	Description .....	11
5.3.2	Responsibilities.....	12
5.3.3	Entry Criteria.....	13
5.3.4	Exit Criteria .....	13
5.4	Bilateral Interoperability Testing Stage .....	13
5.4.1	Description .....	13
5.4.2	Responsibilities.....	14
5.4.3	Entry Criteria .....	14
5.4.4	Exit Criteria .....	15
5.4.5	NCB Certification.....	16
5.4.5.1	Description.....	16

# Currency Participation Agreement

## Schedule 3 – User Testing

---

5.4.5.2	Responsibilities .....	17
5.4.5.3	Entry Criteria.....	18
5.4.5.4	Exit Criteria.....	18
5.5	Multilateral Interoperability Testing Stage .....	18
5.5.1	Description .....	18
5.5.2	Responsibilities.....	18
5.5.3	Entry Criteria.....	19
5.5.4	Exit Criteria.....	19
<b>5.6</b>	<b>Community Testing Stage.....</b>	<b>20</b>
5.6.1	Description .....	20
5.6.2	Responsibilities.....	20
5.6.3	Entry Criteria.....	20
5.6.4	Exit Criteria.....	21
5.6.5	DCA Holder Certification .....	22
5.6.5.1	Description.....	22
5.6.5.2	Responsibilities .....	23
5.6.5.3	Entry Criteria.....	23
5.6.5.4	Exit Criteria.....	24
5.7	Business Day Testing Stage .....	24
5.7.1	Description .....	24
5.7.2	Responsibilities.....	24
5.7.3	Entry criteria.....	25
5.7.4	Exit criteria.....	25
<b>6</b>	<b>Non-functional tests .....</b>	<b>27</b>
6.1	Description.....	27
6.2	Objectives and responsibilities of performance and stress tests.....	27
6.3	Objectives and responsibilities of Business Continuity tests .....	28
6.4	Objectives and responsibilities of Security Tests .....	28
6.5	Performance Tests by NCBs .....	29
<b>7</b>	<b>User Testing Business processes .....</b>	<b>30</b>
7.1	User Testing Stage Transition Monitoring Process .....	31
7.1.1	Process Actors and their Roles .....	32
7.1.2	Process Description.....	33
7.2	User Testing Stage Transition Assessment Process .....	34
7.2.1	Process Actors and their Roles .....	35
7.2.2	Process Description.....	36

# Currency Participation Agreement

## Schedule 3 – User Testing

---

7.3	User Testing Stage Transition Bilateral Escalation Process .....	37
7.3.1	Process Actors and their Roles .....	38
7.3.2	Process Description.....	38
7.4	User Testing Suspension Process .....	39
7.4.1	Process Actors and their Roles .....	40
7.4.2	Process Description.....	40
7.5	Release management during the User Testing .....	41
7.6	Supporting processes .....	42
7.6.1	IT Service Management processes .....	42
<b>8</b>	<b>Post-migration testing.....</b>	<b>43</b>
	<b>Annex 1 – Mapping of testing activities on the test environments .....</b>	<b>1</b>

# Currency Participation Agreement

## Schedule 3 – User Testing

---

### 1 **1 Introduction**

#### 2 **1.1 Context**

3 A prerequisite for a secure and smooth transfer of settlement activities from the CSDs’  
4 proprietary IT environments to T2S is the thorough testing of T2S in combination with the IT  
5 systems of the T2S Actors. According to the T2S Principle 10, “T2S shall be technically capable  
6 of settling currencies other than the euro”, so non-euro area NCBs may wish to participate in T2S  
7 by making their domestic currency available in T2S for central bank money settlement of  
8 securities transactions. In which case, the non-euro area NCBs will need to test T2S with their  
9 domestic currency to ensure that the liquidity management functions correspond to the  
10 requirements of the non-euro area NCBs.

11 In this context, the Connected National Central Bank (NCB) and the Eurosystem shall cooperate  
12 in good faith for the preparation and execution of all relevant User Testing activities according to  
13 the T2S Programme Plan and its milestones.

#### 14 **1.2 Structure of Schedule**

15 The Schedule 3 consists of the following sections and Annexes.

16 Section 1 is the introduction.

17 Section 2 defines the scope and the objective of User Testing.

18 Section 3 presents the general responsibilities of the Eurosystem, the NCBs and the PMG  
19 substructure for User Testing.

20 Section 4 describes the objectives of the User Testing preparation phase and the responsibilities  
21 of the Eurosystem and the NCBs during this phase.

22 Section 5 describes the structure of the testing stages for the User Testing Execution Phase with  
23 the respective entry and exit criteria for each testing stage as well as the conditions for  
24 transitioning between testing stages.

25 Section 6 presents the description, objectives and responsibilities for the non-functional testing.

26 Section 7 presents the business processes required to support the successful completion of User  
27 Testing including the stage transition process.

28 Section 8 presents the post-migration testing.

29 Annex 1 describes the mapping of the testing activities on the test environments.

30

# Currency Participation Agreement

## Schedule 3 – User Testing

---

### 31 **2 Scope and Objectives**

#### 32 **2.1 Scope**

33 The scope of User Testing comprises functional testing and non-functional testing that the  
34 Connected NCB and its Dedicated Cash Account (DCA) Holders perform in view of assessing:

- 35     ▪ the ability to connect to T2S (connectivity testing);
- 36     ▪ the compliance of T2S with the relevant T2S Services as defined in Schedule 5 (Service  
37       Description) and the T2S Scope Defining Set of Documents (NCB Acceptance Tests of  
38       the T2S Services);
- 39     ▪ the ability to interact properly with T2S (bilateral and multilateral interoperability testing  
40       as well as community and business day testing) without negative impact on the T2S  
41       Platform or other connected parties (NCB certification and DCA Holder certification);
- 42     ▪ the ability to migrate static and, to the extent required, transactional data from its legacy  
43       systems onto T2S (Migration testing, mainly assessed during bilateral interoperability  
44       testing and community testing);
- 45     ▪ the ability to extract Static Data and Transactional Data from T2S for reverse migration;  
46       and
- 47     ▪ the readiness of operational procedures for live operations.

48 Although the functional and non-functional tests that the Eurosystem performs do not fall into the  
49 scope of User Testing, evidence provided through these tests may be used on a discretionary  
50 basis by NCBs as a means to limit their efforts during User Testing.

#### 51 **2.2 Objectives**

52 The objectives of the User Testing are:

- 53     ▪ to provide evidence that the T2S Platform meets the user requirements, as defined by the  
54       most recently approved version of the most detailed document of the T2S Scope Defining  
55       Set of Documents and Schedule 5 (T2S Service Description);
- 56     ▪ to ensure readiness of the Connected NCB and its DCA Holders as well as its CSD for  
57       the migration to and operation on the T2S Platform;
- 58     ▪ to allow the Connected NCB to verify and ensure its compliance with Legal and



# Currency Participation Agreement

## Schedule 3 – User Testing

---

59 Regulatory Requirements during the Operational Phase of T2S.

### 60 **3 General Responsibilities of the Contracting Parties**

61 This section defines the respective responsibilities of the Eurosystem, the Connected NCB,  
62 whose currency is available for settlement in T2S, and the PMG substructure for the preparation  
63 and execution of all User Testing activities. This Schedule does not define the roles and  
64 responsibilities of the CSDs, nor of the DCA Holders, but defines the responsibility both of the  
65 Eurosystem to ensure that these T2S Stakeholders fulfil their obligations and of the Connected  
66 NCB towards its DCA Holders.

#### 67 **3.1 General responsibilities of the Eurosystem**

68 The following specifies the general responsibilities of the Eurosystem with regard to the  
69 preparation and execution and completion of the User Testing activities:

- 70 i. The Eurosystem is responsible for coordinating the User Testing activities and  
71 communication between the Connected NCB, whose currency is available for  
72 settlement in T2S, and its domestic CSD as well as between the Connected NCB and  
73 other CSDs participating in the User Testing activities;
- 74 ii. The Eurosystem shall ensure that the User Testing of the NCBs does not place  
75 restrictions on the CSDs' testing and that the User Testing of the CSDs does not place  
76 restrictions on the NCBs' testing;
- 77 iii. The Eurosystem shall actively take all necessary actions required to facilitate, monitor  
78 and support the adequate participation of the Participating CSDs in the testing activities  
79 of the Connected NCB, whose currency is available for settlement in T2S, as well as for  
80 the adequate participation of the Connected NCB in the testing activities of the  
81 Participating CSDs;
- 82 iv. The Eurosystem is responsible for preparing and executing the Eurosystem Acceptance  
83 Testing (EAT), and for providing regular progress reporting as well as an assessment  
84 report confirming the compliance of T2S with the T2S Scope Defining Set of  
85 Documents and Schedule 5 (Service DescriptionT2S Service Description); before the  
86 start of User Testing.
- 87 v. The Eurosystem shall provide the reasonable support for testing activities of the  
88 Connected NCB in the different stages of User Testing;

# Currency Participation Agreement

## Schedule 3 – User Testing

---

- 89 vi. The Eurosystem shall inform the Connected NCB, in a timely manner, about any  
90 developments, which may prevent that NCB or its DCA Holder(s) from completing  
91 its/their testing activities; and shall propose identified mitigation measures;
- 92 vii. The Eurosystem shall ensure that a PMG substructure is in place, in accordance with  
93 the T2S governance framework (section 2.4 of Schedule 8 - Governance), for the  
94 planning, coordination and monitoring of the User Testing activities;
- 95 viii. The Eurosystem shall reconcile and consolidate the individual status reports of NCBs  
96 and CSDs on the progress of their User Testing activities and shall provide a regular  
97 status update based on this consolidation to the Connected NCB through the PMG  
98 substructure;
- 99 ix. The Eurosystem shall investigate and reconcile different test outcomes by different  
100 NCBs or DCA Holders for delivering a consolidated list of defects to the PMG  
101 substructure;
- 102 x. The Eurosystem shall undertake the configuration of test environments for the different  
103 testing stages as agreed with the PMG substructure. The Eurosystem will provide the  
104 necessary data configurations to ensure the logical segregation of data for the test  
105 activities of NCBs;
- 106 xi. The Eurosystem is responsible for maintaining configuration parameters and the User  
107 Testing Calendar (settlement day calendar, operating hours, cut-off times, etc.) for each  
108 test environment as agreed with the PMG substructure for User Testing;
- 109 xii. Based on the principles of ITIL V3 Service Operation, the Eurosystem shall establish  
110 and operate the necessary IT service management processes that include a defect  
111 resolution process to remedy errors;
- 112 xiii. The Eurosystem shall operate T2S in accordance with the SLAs for User Testing as  
113 defined in Schedule 6 (T2S Service Level Agreement).

### 114 **3.2 General responsibilities of the Connected NCB**

115 The following specifies the general responsibilities of the Connected NCB for the preparation  
116 and execution of the User Testing activities:

- 117 i. The Connected NCB is responsible for the communication with its DCA Holders  
118 regarding User Testing;

# Currency Participation Agreement

## Schedule 3 – User Testing

---

- 119       ii. The Connected NCB is responsible for ensuring the timely completion of all its testing  
120           activities and shall report its findings on the execution of its test cases and test scenarios  
121           to the Eurosystem on a regular basis;
- 122       iii. The Connected NCB is responsible for supporting and monitoring the timely  
123           completion of the testing activities of its DCA Holders;
- 124       iv. The Connected NCB appoints a single point of contact for all topics related to the User  
125           Testing representing the Connected NCB in the PMG substructure;
- 126       v. The Connected NCB, independent of its migration wave and even after having  
127           completed its own testing, shall support CSDs in their testing of T2S;
- 128       vi. The Connected NCB shall inform the Eurosystem, in a timely manner, about any  
129           developments, which may prevent that NCB or its DCA Holder(s) from completing  
130           its/their testing activities;
- 131       vii. The Connected NCB shall provide reasonable support to the Eurosystem by providing  
132           information on test outcomes;
- 133       viii. The Connected NCB shall participate in the PMG substructure in charge of User  
134           Testing as required to ensure the proper functioning of this body and the smooth  
135           coordination of the User Testing activities.

### 136   **3.3 General responsibilities of the PMG Substructure**

137   The PMG substructure shall be composed of the participating CSDs, euro area NCBs,  
138   participating non-euro area NCBs, the 4CB and the ECB. The following specifies the general  
139   responsibilities of the PMG substructure in the preparation and execution of the User Testing  
140   activities for the initial T2S go-live and new software release after T2S go-live of the final  
141   migration wave that the substructure shall be responsible for:

- 142       i. Meet (physically or via conference call) on a regular basis and on an ad hoc basis when  
143           requested by one of the members to prepare, plan, coordinate, monitor and review User  
144           Testing activities. The PMG substructure determines the frequency of its meetings  
145           based on its needs;
- 146       ii. Prepare, update and agree the User Testing Calendar in accordance with the TS  
147           Programme Plan;
- 148       iii. Decide on changes to the opening / closing times of the testing environments and  
149           operational hours in line with the provisions of the SLA;

# Currency Participation Agreement

## Schedule 3 – User Testing

---

- 150       iv.    Review the consolidated User Testing status reports from the Eurosystem on the overall  
151            progress of NCBs, CSDs and their respective communities on User Testing;
- 152       v.     Review the list of incidents;
- 153       vi.   Review the software defects, classify the software defects and agree on the contents of a  
154            package for a T2S release on the User Testing environments.
- 155       vii.  In the case that the PMG substructure cannot reach an agreement, it may escalate to the  
156            PMG;
- 157       viii. Prepare communication on the progress of User Testing via the PMG to the Steering  
158            Level;
- 159       ix.   Coordinate and monitor the participation of the various T2S Actors (Eurosystem,  
160            NCBs, CSDs, DCPs and DCA Holders) during the different stages of testing. At its own  
161            discretion, the NCB may coordinate testing activities directly with other T2S Actors  
162            when it does not conflict with the agreed approach of the PMG substructure;
- 163       x.    Identify, manage, report and escalate risks and issues related to User Testing according  
164            to the ‘Programme Plan Preparation, Adaptation and Assessment Review Process’ in  
165            section 7.2 of Schedule 2 (T2S Programme Planning and Monitoring);
- 166       xi.   Request plan changes related to User Testing according to the ‘Programme Plan  
167            Preparation, Adaptation and Assessment Review Process’ in section 7.2 of Schedule 2  
168            (T2S Programme Planning and Monitoring);
- 169       xii.  Request adaptations of User Testing items documented in Annexes 4 to 10 of Schedule  
170            2, according to the ‘Adaptation Process for Updated Annexes without affecting the  
171            plan’ in section 7.3 of Schedule 2 (T2S Programme Planning and Monitoring);
- 172       xiii. Take or request decisions on User Testing related topic according to the decision-  
173            making process defined section 1.3 of in Schedule 8 (Governance).

### 174   **3.4    General responsibility related to Monitoring Client Readiness**

175   The monitoring and reporting of the progress of an individual NCB with its client relationship  
176   manager during User Testing will follow the framework for Monitoring Client Readiness (MCR)  
177   as defined in Schedule 2 (T2S Programme Planning and Monitoring).

178

# Currency Participation Agreement

## Schedule 3 – User Testing

---

### 179 **4 User Testing Preparation Phase**

180 The objective of the User Testing preparation phase is to:

- 181     ▪ organise processes and activities required for the User Testing Execution Phase, as  
182     defined in Section 7 of this Schedule;
- 183     ▪ undertake an initial risk assessment for the User Testing Execution Phase as specified by  
184     the Schedule 2 risk management framework to ensure the subsequent proactive risk  
185     management by the PMG substructure;
- 186     ▪ prepare and design all necessary test documentation and testing processes, e.g. User  
187     Testing Calendar, Test Plan, test cases for certification, test data.

188 In this preparation phase for User Testing, the Eurosystem with the support of the Connected  
189 NCB through its participation in the PMG substructure for User Testing establishes the required  
190 process framework and prepares the agreed deliverables for the User Testing Execution Phase.

191 The responsibilities of **the Eurosystem** in this phase are:

- 192     i. to establish the processes required for the User Testing Execution Phase as defined in  
193     Section 7 of this Schedule;
- 194     ii. to develop a training programme for T2S and deliver a reasonable amount of training to  
195     the Connected NCB;
- 196     iii. to provide the Connected NCB with a Test Plan and User Testing Calendar for the  
197     Connected NCB to plan its own activities for the User Testing and to inform the  
198     Connected NCB, in a timely manner, about any changes made to this plan;
- 199     iv. to prepare and provide the prerequisite deliverables for the Connected NCB to prepare  
200     its User Testing, e.g. the User Testing Guide, the Registration Guide, the Connectivity  
201     Guide, and the Manual of Operational Procedures;
- 202     v. to provide to the Connected NCB the sets of Eurosystem Acceptance Testing (EAT)  
203     functional test cases and test scenarios for information purposes, as an input for the  
204     Connected NCB's test preparation.

205 In this preparation phase for User Testing, the responsibilities of **the Connected NCB** are:

- 206     i. to support the Eurosystem in the preparation of the overall Testing Calendar by

## Currency Participation Agreement

### Schedule 3 – User Testing

---

207 providing the Eurosystem with its proposed Test Plan and User Testing Calendar of its  
208 activities.

209 ii. to comply with the processes for User Testing, as defined in Section 7 of this Schedule.

210

# Currency Participation Agreement

## Schedule 3 – User Testing

---

### 211 5 User Testing Execution Phase

212 This section describes the structure of the testing stages for User Testing Execution Phase with  
213 the respective entry and exit criteria for each testing stage as well as the conditions for  
214 transitioning between testing stages.

#### 215 5.1 Testing Stage Organisation

216 The User Testing Execution Phase consists of both independent and sequenced testing stages.  
217 The purpose of the different testing stages is to increase gradually the number of T2S Actors  
218 involved and expand the scope of the testing.

219

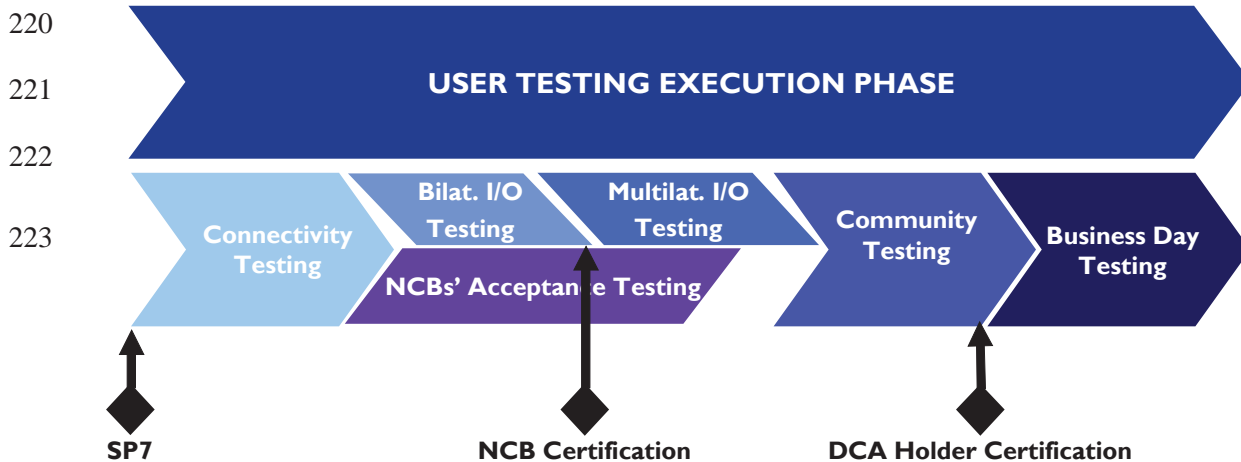

# Currency Participation Agreement

## Schedule 3 – User Testing

---

### 224 5.2 Connectivity Testing Stage

#### 225 5.2.1 Description

226 Establishing the technical connectivity to a test environment is the first stage of User Testing.  
227 This is required for each environment that the Connected NCB uses for testing, however the  
228 connectivity testing stage is the initial verification that the systems of both the Connected NCB  
229 and the Eurosystem can communicate successfully on the technical and application level. The  
230 Connected NCB shall repeat these tests for each connectivity channel it intends to use while the  
231 connection to further T2S test environments might have a reduced connectivity test scope.

232 Directly connected DCA Holders will need to perform connectivity testing before they can start  
233 DCA Holder Certification Testing. Such connectivity testing has to take place before the start of  
234 community testing in compliance with the planning outlined in CPA Schedule 2.

235 The scope of connectivity testing consists of

- 236     ▪ testing the ability to reach the welcome pages of the U2A interface and performing the  
237         login to the system;
- 238     ▪ exchange of messages on application level (not relevant for directly connected DCA  
239         Holders with U2A connection);
- 240     ▪ push-and-pull services for reports (not relevant for directly connected DCA Holders with  
241         U2A connection).

242 When the Connected NCB has opted for the Dedicated Link Connection, the testing shall also  
243 cover the testing of the technical communication protocol (DEP).

#### 244 5.2.2 Responsibilities

245 The following set of responsibilities shall apply for the connectivity testing stage:

- 246     i. The Eurosystem shall support the connectivity testing of the Connected NCB and the  
247         DCA Holders.
- 248     ii. The Connected NCB shall acquire T2S specific network connectivity services and  
249         ensure the timely readiness of its connection to the relevant T2S environment(s).
- 250     iii. The Connected NCB together with the Eurosystem will evaluate the test results at the  
251         end of the connectivity testing stage to assess the fulfilment of the exit criteria for this  
252         testing stage.



# Currency Participation Agreement

## Schedule 3 – User Testing

---

### 253 **5.2.3 Entry Criteria**

254 The following conditions shall apply for the start of the connectivity testing stage:

- 255     ▪ The Eurosystem has confirmed the successful achievement of synchronisation point 4 –  
256         Network Providers Confirmed.
- 257     ▪ The Eurosystem has confirmed the successful achievement of synchronisation point 7 –  
258         Start Connectivity Testing.
- 259     ▪ The Connected NCB has completed the preparation to setup the network connection for  
260         the user test environments, according to the T2S Connectivity Guide.
- 261     ▪ The Connected NCB has confirmed the adaptation of its IT system according to the T2S  
262         specifications and documentation.

### 263 **5.2.4 Exit Criteria**

264 The following conditions shall apply for the successful conclusion of the connectivity testing  
265 stage:

- 266     ▪ The Connected NCB confirms to the Eurosystem that its IT platform can successfully  
267         exchange message-based communication and receive pushed messages on application  
268         level with T2S.

269 The Connected NCB confirms the correct setup of communication parameters and security  
270 features with its Network Service Provider(s) in order to communicate with the T2S test  
271 environment(s).

## 272 **5.3 NCBs' Acceptance Testing Stage**

### 273 **5.3.1 Description**

274 The NCBs' acceptance testing stage is of up to 6 months within the User Testing Execution  
275 Phase reserved for NCBs to confirm that based on its testing the relevant T2S Services comply  
276 with Schedule 5 (T2S Service Description) and the T2S Scope Defining Set of Documents, i.e.  
277 services related to cash accounts, liquidity management and auto-collateralisation. Independently  
278 from its migration wave, the Connected NCB may start its acceptance testing when the  
279 Eurosystem confirms its successful achievement of synchronisation point 8 – Start Bilateral  
280 Interoperability Testing.

# Currency Participation Agreement

## Schedule 3 – User Testing

---

281 The NCBs' Acceptance Tests of the T2S Services<sup>1</sup> are bilateral between the Eurosystem and the  
282 Connected NCB. The acceptance of one NCB does not prejudice the agreement by other NCBs.  
283 Executing this testing stage is optional. The Connected NCB may rely on its test results from its  
284 bilateral and multilateral interoperability testing as well as those from its NCB certification  
285 testing. Article 13 of the core Agreement defines NCBs' Acceptance Tests further.

286 In order for the Connected NCB to obtain evidence that T2S fulfils the non-functional user  
287 requirements, the Eurosystem will prepare and execute non-functional tests based on test cases  
288 that will be shared with the Connected NCB for a consultation, within a specified time frame,  
289 before the start of non-functional testing by the Eurosystem. The Eurosystem will deliver a test  
290 report with the results of the test execution according to the defined scope of the non-functional  
291 tests.

### 292 **5.3.2 Responsibilities**

293 The following set of responsibilities shall apply for the NCBs' acceptance testing stage:

- 294 i. In the context of the framework set out in Schedule 2 (T2S Programme Planning and  
295 Monitoring) on the monitoring of client readiness, the Eurosystem and the Connected  
296 NCB shall have regular contact to review the progress of the NCBs' acceptance testing  
297 stage;
- 298 ii. The Connected NCB has the obligation to provide regular reporting on the results of its  
299 tests in the form of status reports to the Eurosystem. The report shall cover at minimum  
300 the number of test cases and test scenarios successfully executed and failed (cases of  
301 non-compliance) with the Connected NCB's assessment of the criticality of identified  
302 defects and corresponding measures to compensate for potential delays, when required;
- 303 iii. The Connected NCB has the obligation to provide evidence, if it intends not to accept  
304 T2S because of failed test cases, that the respective test cases comply with the T2S  
305 Scope Defining Set of Documents and Schedule 5 (T2S Service Description).

---

<sup>1</sup> The term "NCBs' Acceptance Tests of the T2S Services" does not indicate that the T2S Services imply any element of a contract for work under German law. Chapter 2 of this Agreement defines the rights and obligations of the Parties that describe the T2S Services

# Currency Participation Agreement

## Schedule 3 – User Testing

---

306 iv. Based on the bilateral status reporting from the Connected NCB, the Eurosystem shall  
307 monitor the testing. The Eurosystem shall share information about the progress and  
308 results of the NCBs' Acceptance Tests of the T2S Services with the NCBs via the PMG  
309 substructure on a consolidated basis.

310 v. The Connected NCB together with the Eurosystem will evaluate the test results at the  
311 end of the NCBs' acceptance testing stage to assess the fulfilment of the exit criteria for  
312 this testing stage.

### 313 5.3.3 Entry Criteria

314 The following condition shall apply for the start of the NCBs' acceptance testing stage:

- 315 ▪ The Eurosystem has confirmed the successful achievement of synchronisation point 8 –  
316 Start Bilateral Interoperability Testing.

### 317 5.3.4 Exit Criteria

318 The following conditions shall apply for the end of the NCBs' acceptance testing stage:

- 319 ▪ The criterion for an NCB to exit the NCBs' acceptance testing stage shall be its  
320 declaration that evidence from testing (whereby the Connected NCB may rely on its test  
321 results from its bilateral and multilateral interoperability testing as well as those from its  
322 NCB certification testing) suggests that the relevant T2S services comply with Schedule  
323 5 (T2S Service Description) and the T2S Scope Defining Set of Documents.

## 324 5.4 Bilateral Interoperability Testing Stage

### 325 5.4.1 Description

326 In the bilateral interoperability testing stage, the Connected NCB tests T2S to ensure the  
327 readiness of its adapted IT System to interoperate with T2S and verifies that all relevant T2S  
328 Services (e.g. liquidity management, migration procedures) in T2S are working as required. It  
329 undertakes its testing without interacting with Participating CSDs. T2S ensures the segregation of  
330 the testing activities of the Connected NCB from CSDs' test activities on T2S by creating a set of  
331 fictitious CSDs with which the Connected NCB can interoperate. The objective of this testing  
332 stage is to ensure that the NCBs' adapted IT System can interoperate with T2S properly before  
333 testing with other T2S Actors. An NCB can continue performing bilateral testing even when it  
334 undertakes multilateral testing.

# Currency Participation Agreement

## Schedule 3 – User Testing

---

### 335 **5.4.2 Responsibilities**

336 The following set of responsibilities shall apply for the bilateral interoperability testing stage:

- 337 i. The Eurosystem shall establish the operational procedures and service management  
338 required to support the bilateral interoperability testing stage;
- 339 ii. The Connected NCB is responsible for organising its bilateral interoperability testing  
340 stage in line with the Test Plan and User Testing Calendar;
- 341 iii. The PMG substructure shall be responsible for monitoring the bilateral interoperability  
342 testing stage;
- 343 iv. The Connected NCB shall test the migration processes (loading Static Data, loading  
344 Transactional Data, migration weekend rehearsals, reverse migration, etc.);
- 345 v. The Connected NCB together with the Eurosystem will evaluate the test results at the  
346 end of the bilateral interoperability testing stage to assess the fulfilment of the exit  
347 criteria for this testing stage.

### 348 **5.4.3 Entry Criteria**

349 The following conditions shall apply for the start of the bilateral interoperability testing stage:

- 350 ▪ The Connected NCB has completed the connectivity testing stage successfully;
- 351 ▪ The Eurosystem has provided the EAT Assessment Report four weeks before  
352 synchronisation point 8 – Start Bilateral Interoperability Testing, covering the full scope  
353 of Eurosystem Acceptance Testing and confirming that the Eurosystem considers T2S  
354 being ready for start of User Testing;
- 355 ▪ The Eurosystem has resolved all reported defects classified with critical severity,  
356 identified during EAT. Except otherwise agreed between the Parties, the Eurosystem has  
357 resolved all recorded defects classified with high severity;
- 358 ▪ For the pending errors from the EAT, the Eurosystem has provided a timetable for  
359 implementation of software corrections and for regression testing of those corrections for  
360 those test cases that failed because of defects in T2S that are not critical;
- 361 ▪ The Eurosystem has confirmed the successful achievement of synchronisation point 8 –  
362 Start Bilateral Interoperability Testing for the specific migration wave;
- 363 ▪ The Eurosystem has delivered to the Connected NCB preliminary evidence that the

# Currency Participation Agreement

## Schedule 3 – User Testing

---

364 future T2S production environment will meet the non-functional requirements based on  
365 the results of the T2S non-functional tests. The Eurosystem executes these tests in the  
366 future T2S production environment;

- 367     ▪ The Eurosystem has confirmed its operational readiness to support the Connected NCB;
- 368     ▪ The Connected NCB has confirmed its readiness to start User Testing;
- 369     ▪ The Eurosystem and the Connected NCB have confirmed completion of the training  
370 required to ensure the smooth start of testing activities;
- 371     ▪ The Eurosystem has provided the documentation required for migration testing and  
372 migration dress rehearsals.

### 373 **5.4.4 Exit Criteria**

374 The following condition shall apply for the end of the bilateral interoperability testing stage:

- 375     ▪ The Eurosystem has certified the Connected NCB according to the requirements in  
376 Section 5.4.5 of this Schedule.

# Currency Participation Agreement

## Schedule 3 – User Testing

---

### 377 5.4.5 NCB Certification

#### 378 5.4.5.1 Description

379 The NCB certification, conducted during the User Testing Execution Phase, aims at providing  
380 evidence by the Connected NCB that its adapted IT platform does not harm T2S as the result of  
381 inappropriate technical communication or procedures. It runs in parallel to the bilateral  
382 interoperability testing stage. The Connected NCB's participation in the NCB certification testing  
383 is mandatory. Certification shall require the Connected NCB to execute a mandatory set of  
384 reasonable tests, agreed through the PMG substructure during the User Testing preparation  
385 phase<sup>2</sup>. The Eurosystem will exempt the Connected NCB from performing mandatory test cases  
386 that are not in the scope of the Connected NCB's intended usage of T2S. The Connected NCB  
387 may rely on its test results from its bilateral testing to document its completion of a mandatory  
388 certification test case.

389 NCB certification is bilateral between the Eurosystem and the Connected NCB. The Eurosystem  
390 shall provide written confirmation to the Connected NCB after determining whether the  
391 Connected NCB has successfully completed its assigned set of mandatory certification test cases,  
392 based on a formal report from the Connected NCB in which the Connected NCB shall document  
393 its fulfilment of the predefined NCB certification testing exit criteria.

394 The Eurosystem shall retain as evidence for proper certification the Connected NCB's formal  
395 report as well as the Connected NCB's progress reports on its certification testing and reporting  
396 on the level of the test cases and test scenarios.

397 The certification of the Connected NCB shall remain valid until:

- 398     ▪ the Eurosystem deploys a major release with a significant scope change in the A2A  
399         interface or major structural changes to the processing model and/or data model; or
- 400     ▪ the Connected NCB has made major changes to its interface processing for T2S.

---

<sup>2</sup> Only for NCB certification there will be mandatory test cases.

# Currency Participation Agreement

## Schedule 3 – User Testing

---

401 In the first case, the Eurosystem shall recommend to the Steering Level whether the new release  
402 requires a re-certification of the NCBs and CSDs, based on the scope of the changes that the  
403 Change Review Group (CRG) has approved for the new T2S release. In the latter case, the  
404 Connected NCB shall assess the scope of the changes and shall decide whether it must undertake  
405 a re-certification.

### 406 5.4.5.2 Responsibilities

407 The following set of responsibilities shall apply for the NCB certification testing:

- 408 i. The Eurosystem shall deliver for review to the Connected NCB through the PMG  
409 substructure the test scenarios and test cases that the Connected NCB has to execute  
410 successfully to achieve its certification;
- 411 ii. The Eurosystem shall consult the PMG substructure on the test cases and test scenarios  
412 for NCB certification to ensure and agree the proper scope coverage;
- 413 iii. In the context of the framework set out in Schedule 2 on the monitoring of client  
414 readiness, the Eurosystem and the Connected NCB shall have regular contact to review  
415 the progress of the NCB's certification testing;
- 416 iv. The Connected NCB shall execute the mandatory test cases and test scenarios for  
417 certification within the period foreseen in the T2S Programme Plan for the migration  
418 wave in which it is participating;
- 419 v. The Connected NCB has the obligation to provide regular reporting on the results of its  
420 certification tests in the form of status reports to the Eurosystem, documenting its  
421 progress with, at minimum, the number of test cases and test scenarios successfully  
422 executed and failed;
- 423 vi. Based on the bilateral status reporting from the Connected NCB, the Eurosystem shall  
424 monitor the certification testing. The Eurosystem shall share information about the  
425 progress of and results of the NCB Certification with the NCBs via the PMG  
426 substructure on a consolidation basis;
- 427 vii. Based on a formal report from the Connected NCB, the Eurosystem will evaluate the  
428 results of the NCB's certification testing to assess whether the Connected NCB  
429 executed the certification tests completely and successfully, and such assessment shall  
430 not be unreasonably withheld;

# Currency Participation Agreement

## Schedule 3 – User Testing

---

431       viii. The Eurosystem will issue the NCB Certificate for the Connected NCB when the  
432               Eurosystem assesses that the Connected NCB has executed the certification test cases  
433               completely and successfully.

### 434   **5.4.5.3 Entry Criteria**

435   The following conditions shall apply for the start of the NCB certification:

- 436       ▪ The Connected NCB has completed the connectivity testing stage successfully;
- 437       ▪ As specified in the T2S Programme Plan, the Eurosystem has delivered to the Connected  
438               NCB its test scenarios and test cases that the Connected NCB is to execute for its  
439               certification;
- 440       ▪ The PMG substructure has assessed the test cases and test scenarios for NCB  
441               Certification to ensure proper scope coverage.

### 442   **5.4.5.4 Exit Criteria**

443   The following conditions shall apply for the successful conclusion of the NCB certification:

- 444       ▪ The Connected NCB has provided evidence of its successful completion of the  
445               mandatory certification test cases and test scenarios;
- 446       ▪ The Eurosystem has confirmed in writing to the Connected NCB that the Connected  
447               NCB has successfully completed all tests required for certification.

## 448   **5.5 Multilateral Interoperability Testing Stage**

### 449   **5.5.1 Description**

450   In the multilateral interoperability testing stage, the Connected NCB tests with other Participating  
451   CSDs and Central Banks of its migration wave and of previous migration waves. In this stage, the  
452   Connected NCB also begins the set-up and testing of configuration data and parameters for the  
453   intended production set-up (e.g. message subscriptions, liquidity transfers).

### 454   **5.5.2 Responsibilities**

455   The following set of responsibilities shall apply for the multilateral interoperability testing stage:

- 456       i. The PMG substructure shall be responsible for the planning and coordination of the  
457               multilateral interoperability testing stage;



# Currency Participation Agreement

## Schedule 3 – User Testing

---

458       ii. The Connected NCB shall support Participating CSDs of its own migration wave and of  
459           subsequent migration waves when it supports cash accounts of customers of those  
460           Participating CSDs;

461       iii. The PMG substructure will evaluate the test results at the end of the multilateral  
462           interoperability testing stage to assess the fulfilment of the exit criteria for this testing  
463           stage.

### 464   **5.5.3       Entry Criteria**

465   The following conditions shall apply for the start of the multilateral interoperability testing stage:

466       ▪ The Connected NCB has obtained its certification in order to start multilateral  
467       interoperability testing;

468       ▪ The PMG substructure has assessed the User Testing Stage Report detailing the severity  
469       of all defects reported during the multilateral interoperability testing stage and not yet  
470       resolved.

### 471   **5.5.4       Exit Criteria**

472   The following conditions shall apply for the end of the multilateral interoperability testing stage:

473       ▪ The PMG substructure determines that the Connected NCBs of a migration wave have  
474       successfully completed multilateral interoperability testing;

475       ▪ No critical software bugs or operational issues remain open. The Eurosystem has  
476       resolved all reported defects classified with critical severity. Except the Parties agree  
477       otherwise, the Eurosystem has resolved all recorded defects, classified with high severity;

478       ▪ The PMG substructure has agreed a timetable for implementation of software corrections  
479       and for regression testing of those corrections for those test cases that failed because of  
480       non-critical defects in T2S.

# Currency Participation Agreement

## Schedule 3 – User Testing

---

### 481 **5.6 Community Testing Stage**

#### 482 **5.6.1 Description**

483 The community testing stage is the stage in which the Connected NCB of a migration wave  
484 extends its multilateral testing activities with other relevant T2S Actors to its DCA Holders. The  
485 main objective of this stage is to validate that the Connected NCB's DCA Holders can interact  
486 correctly end-to-end with T2S, either through the Connected NCB's adapted systems or with T2S  
487 directly as a directly connected DCA Holder.

488 During the testing stage NCBs and their DCA Holders verify the correct functioning of T2S  
489 using the target data configuration as configured for the target production environment. The  
490 expectation is that processing errors will stem mainly from incorrect data configurations,  
491 allowing the Participating NCB to identify and correct such incorrect configurations and from  
492 DCA Holders' testing of their interface to T2S. This stage represents the first opportunity of the  
493 Connected NCB's DCA Holders to test with T2S, allowing the NCB's DCA Holders to verify  
494 that their system interoperate correctly with T2S.

495 The community testing stage allows the Connected NCB and its DCA Holders to familiarise  
496 themselves with operational procedures and service management relevant to this stage to ensure  
497 that the operational procedures as described in the Manual of Operational Procedures (MOP).

#### 498 **5.6.2 Responsibilities**

499 The following set of responsibilities shall apply for the community testing stage:

- 500 i. The Connected NCB shall test the migration process (loading Static Data, loading  
501 Transactional Data, migration weekend rehearsals, reverse migration, etc.) together  
502 with its DCA Holders;
- 503 ii. The Connected NCB shall involve its DCA Holders and other relevant T2S  
504 Stakeholders in the testing activities in order to validate the end-to-end business  
505 processes supported by T2S;
- 506 iii. The Connected NCB together with the Eurosystem will evaluate the test results at the  
507 end of the community testing stage to assess the fulfilment of the exit criteria for this  
508 testing stage.

#### 509 **5.6.3 Entry Criteria**

510 The following conditions shall apply for the start of the community testing stage:

# Currency Participation Agreement

## Schedule 3 – User Testing

---

- 511       ▪ The Connected NCB has exited the NCBs' acceptance testing and the multilateral  
512           interoperability testing stage successfully and declared its operational readiness for  
513           community testing;
- 514       ▪ The Eurosystem has confirmed the readiness of its operational teams;
- 515       ▪ The Eurosystem has confirmed the readiness of the Participating CSD(s) of the  
516           Connected NCB and of the CSD participants in the tests;
- 517       ▪ The PMG substructure confirms the successful completion of multilateral interoperability  
518           testing stage and that the community testing stage can start.

### 519   **5.6.4       Exit Criteria**

520   The following conditions shall apply for the successful conclusion of the community testing  
521   stage:

- 522       ▪ The PMG substructure determines that the Connected NCB, together with its DCA  
523           Holders and the relevant CSD(s) have successfully executed the migration rehearsals and  
524           business days;
- 525       ▪ No critical software bugs or operational issues remain open that constitute a significant  
526           risk to the go-live of the migration wave. The Eurosystem has resolved all reported  
527           defects classified with critical severity. Except where otherwise agreed between the  
528           Parties, the Eurosystem has resolved all recorded defects classified with high severity  
529           except when otherwise agreed between the Parties;
- 530       ▪ The PMG substructure has agreed a timetable for implementation of software corrections  
531           and for regression testing of those corrections for those test cases that failed because of  
532           defects in T2S that are not critical;
- 533       ▪ The DCA Holder(s) of the Connected NCB has/have successfully completed all tests  
534           related to its/their DCA Holder certification which make it/them eligible to participate in  
535           the next stage;
- 536       ▪ The relevant operational and the incident management procedures of the Connected NCB  
537           and its DCA Holders have been carried out successfully;
- 538       ▪ The NCBs and CSD(s) (of the NCBs) of the respective migration wave confirm their  
539           readiness to progress to the business day testing stage.

# Currency Participation Agreement

## Schedule 3 – User Testing

---

### 540 5.6.5 DCA Holder Certification

#### 541 5.6.5.1 Description

542 The DCA Holder Certification aims at providing evidence by those DCA Holders which the  
543 Connected NCB has authorised to connected to T2S with an A2A connection and by those DCA  
544 Holders which the Connected NCB has authorised to connect to T2S with a U2A connection that  
545 its adapted IT platform does not harm T2S as the result of inappropriate technical communication  
546 or procedures. DCA Holders could be given both U2A and A2A access. DCA Holder  
547 Certification does not verify the compliance with either the Connected NCB's adaptation to T2S  
548 nor with the Connected NCB's business processing requirements. Thus, user certification is  
549 necessary but not sufficient prerequisite for a DCA Holder to use an NCB's DCA in T2S. When  
550 conducted during the User Testing Execution Phase, it runs in parallel to the community testing  
551 stage for those participants of the Connected NCB that request to connect directly to T2S.  
552 Participants of the Connected NCB also have the option to undertake their DCA Holder  
553 Certification at anytime after the Connected NCB is operating on T2S. The DCA Holder  
554 certification of an NCB's DCA Holder shall be valid for all Connected NCBs from which it has  
555 authorisation to connect directly to T2S. DCA Holder certification requires connectivity testing  
556 before the DCA Holder starts its certification testing.

557 DCA Holder certification is mandatory for any DCA Holder of the Connected NCB that chooses  
558 to connect its IT systems directly to T2S. DCA Holder certification shall require the DCA Holder  
559 of the Connected NCB to execute a mandatory set of tests, agreed through the PMG substructure  
560 during the User Testing Preparation Phase. When the Connected NCB allows its participants to  
561 connect directly to T2S and the DCA Holder of the Connected NCB chooses to connect directly  
562 to T2S, the Connected NCB shall allow the Eurosystem to undertake the certification process  
563 directly with the DCA Holder of the Connected NCB.

564 A DCA Holder of the Connected NCB has to certify itself once with the Eurosystem to connect  
565 directly to T2S. When the Connected NCB allows its participants to connect directly to T2S, the  
566 Connected NCB has the obligation to accept the certification of its DCA Holder even when the  
567 DCA Holder of the Connected NCB has certified itself with the Eurosystem through another  
568 Connected NCB.

569 The DCA Holder certification of the Connected NCB's DCA Holder shall remain valid until the  
570 Eurosystem deploys a major release with a significant scope change in the A2A / U2A interface  
571 or major structural changes to the processing model and/or data model. The Eurosystem shall  
572 recommend to the Steering Level whether the new release requires a recertification of the DCA  
573 Holders, based on the scope of changes that the Change Review Group (CRG) has approved for  
574 the new T2S release.

# Currency Participation Agreement

## Schedule 3 – User Testing

---

### 575 5.6.5.2 Responsibilities

576 The following set of responsibilities shall apply for the DCA Holder certification testing:

- 577 i. The Eurosystem shall deliver for review to the Connected NCB through the PMG  
578 substructure the test scenarios and test cases that a Connected NCB's DCA Holder has  
579 to execute successfully to achieve its DCA Holder certification;
- 580 ii. The Eurosystem shall consult the PMG substructure on the test cases and test scenarios  
581 for DCA Holder certification to ensure and agree the proper scope coverage;
- 582 iii. The Eurosystem shall undertake the DCA Holder certification process and shall monitor  
583 the DCA Holder certification testing. The NCB will during this process act as a  
584 connecting link between its DCA Holders and the Eurosystem. The Eurosystem shall  
585 share information about the progress and results of the DCA Holder certification with  
586 the NCBs via the PMG substructure on a consolidated basis. The Eurosystem shall  
587 upon request provide (NCB) with the results of such the DCA holder certification  
588 process for (NCB's) DCA Holders;
- 589 iv. The Eurosystem shall provide written confirmation to Connected NCB and to its DCA  
590 Holder after determining whether the DCA Holder has successfully completed its  
591 assigned set of mandatory certification test cases;
- 592 v. The Eurosystem shall retain as evidence for proper DCA Holder certification the  
593 documentation of the DCA Holder's certification testing and reporting on the level of  
594 the test cases and test scenarios;
- 595 vi. In good time before the period foreseen in Schedule 2 for the migration wave in which  
596 it is participating, the (NCB) shall provide the Eurosystem with the necessary  
597 information about those DCA Holders which have been authorised to connect to T2S  
598 with an A2A connection and those which have been authorised to connect to T2S via a  
599 U2A connection.

### 600 5.6.5.3 Entry Criteria

601 The following conditions shall apply for the start of the DCA Holder certification:

- 602 ■ The Connected NCB has fulfilled the exit criteria for the NCBs' acceptance testing stage.
- 603 ■ The Connected NCB and the Eurosystem have fulfilled the exit criteria for the NCB  
604 certification testing;

# Currency Participation Agreement

## Schedule 3 – User Testing

---

- 605       ▪ The Connected NCB has authorised its respective DCA Holder to connect directly to  
606       T2S.

### 607   **5.6.5.4 Exit Criteria**

608   DCA Holder certification has no exit criteria. However, DCA Holder certification is the  
609   prerequisite for the Connected NCB's DCA Holder to take part in community testing of the  
610   Connected NCB as a DCA Holder.

## 611   **5.7 Business Day Testing Stage**

### 612   **5.7.1 Description**

613   The business day testing stage comprises the simulation of several consecutive business days of  
614   T2S operation after completing a migration rehearsal for the respective migration wave using the  
615   expected production data set-up. It includes all NCBs and their DCA Holders as well as the CSDs  
616   of a migration wave and their respective communities. NCBs, CSDs and their communities from  
617   previous migration waves participate when deemed necessary, e.g. when links exist.

618   The objective of the business day testing stage is to verify the correct functioning of T2S under  
619   production-like conditions using the target data configuration as expected in the production  
620   environment. In this stage of testing, the expectation is that processing errors will stem mainly  
621   from incorrectly migrated data (e.g. incorrect positions or missing ISINs) or incorrect  
622   configuration (e.g. cross-CSD settlement parameters). This stage enables the T2S Actors, such as  
623   the CSDs and their communities, to identify such errors using real business data.

624   The business day testing stage includes operational procedures and service management to ensure  
625   that the operational procedures as described in the Manual of Operational Procedures (MOP) are  
626   working as expected.

### 627   **5.7.2 Responsibilities**

628   The following set of responsibilities shall apply for the business day testing stage:

- 629       i. The Eurosystem shall establish the operational procedures and service management  
630       required to support the business day testing stage;
- 631       ii. The Connected NCB shall test the migration process (loading Static Data, loading  
632       Transactional Data, migration weekend rehearsals, reverse migration, etc.) together  
633       with its DCA Holders;

# Currency Participation Agreement

## Schedule 3 – User Testing

---

634       iii. The Connected NCB shall involve its DCA Holders and other relevant T2S  
635           Stakeholders in the testing activities in order to validate the end-to-end business day  
636           processes supported by T2S;

637       iv. The Connected NCB together with the Eurosystem will evaluate the test results at the  
638           end of the business day testing stage to assess the fulfilment of the exit criteria for this  
639           testing stage.

### 640   **5.7.3       Entry criteria**

641   The following conditions shall apply for the start of the business day testing stage:

- 642       ▪ The Connected NCB has fulfilled the exit criteria for the community testing stage;
- 643       ▪ The PMG substructure confirms that the NCBs and their CSD(s) participating in the  
644       respective migration wave have fulfilled the exit criteria for community testing.

### 645   **5.7.4       Exit criteria**

646   The following conditions shall apply for the successful conclusion of the business day testing  
647   stage:

- 648       ▪ The PMG substructure determines that the NCBs of a migration wave, together with their  
649       DCA Holders and the relevant CSDs have successfully executed the migration rehearsals  
650       and business days;
- 651       ▪ No critical software bugs or operational issues remain open that constitute a significant  
652       risk to the go-live of the migration wave. The Eurosystem has resolved all reported  
653       defects classified with critical severity. Except otherwise agreed between the Parties, the  
654       Eurosystem has resolved all recorded defects classified with high severity;
- 655       ▪ The PMG substructure has agreed a timetable for implementation of software corrections  
656       and for regression testing of those corrections for those test cases that failed because of  
657       non-critical defects in T2S;
- 658       ▪ No client systems have become inoperable due to unexpected communication received  
659       from the T2S Platform for at least 15 working days prior to the agreed business day  
660       testing stage exit date;
- 661       ▪ The Eurosystem confirms that testing of operational procedures has been successful;
- 662       ▪ The PMG substructure confirms that appropriate fallback arrangements and rollback

# Currency Participation Agreement

## Schedule 3 – User Testing

---

663            procedures are established and successfully tested for the Migration;

- 664            ▪ The NCBs and CSDs (of the NCBs) of the respective migration wave confirm their  
665            readiness to go-live on T2S.

666



# Currency Participation Agreement

## Schedule 3 – User Testing

---

### 667 **6 Non-functional tests**

668 This section describes the non-functional tests carried out by the Eurosystem in order to confirm  
669 non-functional compliance of T2S as well as the non-functional volume tests carried out by the  
670 NCBs.

#### 671 **6.1 Description**

672 The non-functional tests aim to check the proper functioning of T2S and are composed of the  
673 following tests as defined in the General Technical Design document:

- 674     ▪ performance and stress tests;
- 675     ▪ business continuity tests;
- 676     ▪ security tests.

677 In principal, the Eurosystem will perform the non-functional tests, involvement of NCBs varies  
678 depending on the different types of non-functional test. Prior to the execution, the Eurosystem  
679 will provide for a quick consultation these tests to the NCB. After the test execution, the  
680 Eurosystem will deliver a test report with results of those tests. Moreover, the Connected NCB  
681 will have the opportunity to execute non-functional tests from an end-to-end perspective and  
682 respecting the sizing of the related test environments (see also section 6.5 Performance Tests by  
683 NCBs).

#### 684 **6.2 Objectives and responsibilities of performance and stress tests**

685 The main objective of the performance and stress tests is to check that the T2S production  
686 environment is able to handle the estimated volume of transactions in the peak hour in terms of  
687 the number of settlements and a certain number of concurrent interactive users in compliance  
688 with a defined response time.

689 The test plan for the performance and stress tests includes a global system test aimed to measure  
690 throughput, response time and resource consumption of the whole system (infrastructure and  
691 applications) and volume tests conducted on specific parts of the system in order to optimise the  
692 behaviour of these T2S components.

693 During the performance and stress tests, different test cases shall be performed aiming to  
694 simulate the expected daily workload profiles for User-to-Application mode (U2A) and  
695 Application-to-Application (A2A) interactions on the available interfaces by using simulators  
696 and/or with the collaboration of the Connected NCB.

697 The test plan for the performance and stress tests shall follow a gradual approach to verify, in

# Currency Participation Agreement

## Schedule 3 – User Testing

---

698 sequence, that all infrastructure components and services are properly sized to handle the defined  
699 peak workload of settlements and the T2S application is able to satisfy the defined performance  
700 requirements.

701 The performance and stress tests shall be performed by the Eurosystem. The T2S Actors shall be  
702 invited as observers to the performance and stress tests and the results of these tests shall be  
703 delivered to the Connected NCB.

### 704 **6.3 Objectives and responsibilities of Business Continuity tests**

705 The main objective of the business continuity tests is to verify the ability of T2S to guarantee the  
706 continuity of business services in case of local component failure or regional disaster event. The  
707 business continuity tests shall demonstrate that T2S is sufficiently resilient to meet the agreed  
708 service levels, even in case of severe incidents. The tests include intra-region and inter-region  
709 failover tests to guarantee that the production environment(s) can be switched to another side or  
710 region in a failover situation.

711 The business continuity tests shall be performed before the go-live and on a regular basis after the  
712 go-live.

713 The test plan for the business continuity tests shall include a comprehensive list of test cases  
714 including:

- 715     ▪ fault tolerance (i.e. resiliency of single component);
- 716     ▪ intra-region recovery;
- 717     ▪ inter-region recovery (only regions 1 and 2).

718 In addition, tests shall be performed to validate the rotation between region 1 and region 2 that is  
719 closely linked to the disaster recovery test in terms of organisation and operational procedures.

720 The business continuity tests shall be performed by the Eurosystem. The T2S actors shall be  
721 invited as observers to the business continuity tests and the results of these tests shall be delivered  
722 to the Connected NCB.

### 723 **6.4 Objectives and responsibilities of Security Tests**

724 The main objectives of the security tests are to verify the compliance of the T2S platform with  
725 the T2S security requirements. Security tests include:

- 726     ▪ Vulnerability assessment;
- 727     ▪ Configuration analysis;
- 728     ▪ Penetration tests.

# Currency Participation Agreement

## Schedule 3 – User Testing

---

729 The Eurosystem shall perform these security tests, which it shall provide to the Connected NCB.

### 730 **6.5 Performance Tests by NCBs**

731 Performance tests are typical non-functional tests that an NCB or DCA Holder may want to  
732 perform. Depending on the intended volumes, such tests shall require central coordination and  
733 prior approval.

734 In case the Connected NCB or its DCA Holder(s) intends to exceed the pre-defined hourly  
735 volume limits, the Connected NCB shall send a request for additional processing capacity for  
736 specific performance tests to the Eurosystem at least 5 working days in advance. The request  
737 should contain the expected volumes to be tested and the duration of the test. The Eurosystem  
738 will verify whether it can fulfil the request and shall inform the Connected NCB or its DCA  
739 Holder accordingly. If the Eurosystem cannot fulfil the request as specified, the Eurosystem shall  
740 propose alternative options in terms of dates, times and/or volumes. In case of conflicting  
741 requests, the Eurosystem shall consult the PMG substructure.

## **Currency Participation Agreement**

### **Schedule 3 – User Testing**

---

#### **742 7 User Testing Business processes**

743 This section presents the core business processes that the Eurosystem and Connected NCBs shall comply with for User Testing. The business process description  
744 uses a simplified version of the Business Process Modelling Notation (BPMN) 2.0, as specified in Section 7.1 of Schedule 2 (T2S Programme Planning and  
745 Monitoring).

**Currency Participation Agreement**  
**Schedule 3 – User Testing**

746

**7.1 User Testing Stage Transition Monitoring Process**

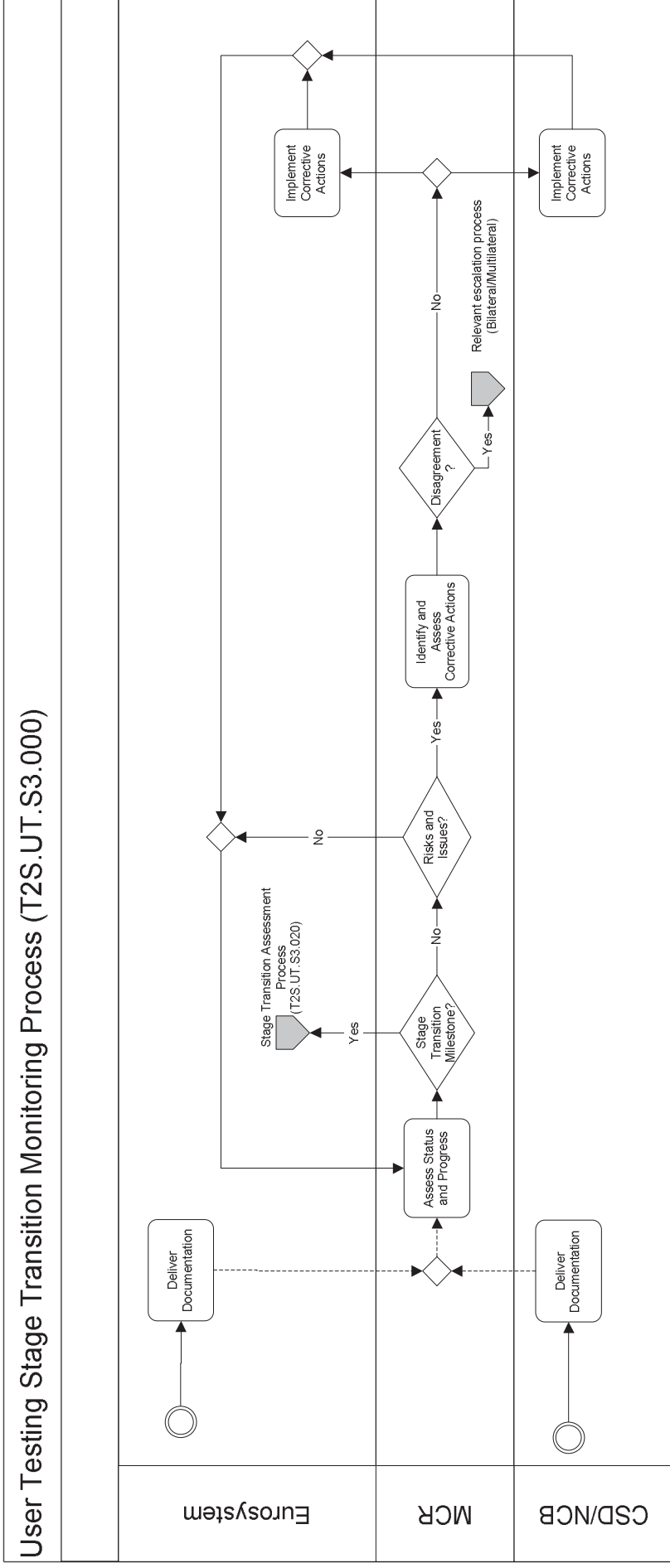

747

# Currency Participation Agreement

## Schedule 3 – User Testing

---

748 **7.1.1 Process Actors and their Roles**

Process Actor	Process Role
CSD / NCB	<p>In this process, the CSD / NCB is responsible for :</p> <ul style="list-style-type: none"><li>▪ Providing a sufficient level of documentation to the Eurosystem to allow the Eurosystem to assess the Connected NCB's progress for a testing stage;</li><li>▪ Assessing its fulfilment of the entry and exit criteria for a testing stage;</li><li>▪ Identifying assessing the feasibility of proposed correction actions, when required; and</li><li>▪ Discussing the feasibility of the proposed corrective actions with the Eurosystem.</li></ul>
Eurosystem	<p>In this process, the Eurosystem is responsible for:</p> <ul style="list-style-type: none"><li>▪ Providing a sufficient level of documentation to the Connected NCB to allow the Connected NCB to assess the Eurosystem's fulfilment of the entry / exit criteria for a testing stage;</li><li>▪ Assessing its fulfilment of the entry and exit criteria for a testing stage;</li><li>▪ Identifying assessing the feasibility of proposed correction actions, when required; and</li><li>▪ Discussing the feasibility of the proposed corrective actions with the Connected NCB.</li></ul>
Monitoring of Client Readiness (MCR)	<p>In this process, the MCR:</p> <ul style="list-style-type: none"><li>▪ Monitors the Connected NCB's progress in order to determine whether it has fulfilled the entry or exit criteria for a testing stage; and</li><li>▪ Discusses and decides on the feasibility of proposed corrective actions; and</li><li>▪ Provide guidance to the PMG substructure when required in the case of multilateral escalation.</li></ul>

749

750

# Currency Participation Agreement

## Schedule 3 – User Testing

---

### 751 7.1.2 Process Description

752 The objective of the User Testing stage transition monitoring process is to ensure bilateral  
753 communication between the Eurosystem and the Connected NCB on the progress of the  
754 Connected NCB's User Testing

- 755     ▪ to ensure adequate coordination of the User Testing activities;
- 756     ▪ to enable proactive monitoring of the NCB's fulfilment of the exit and/or entry criteria  
757         for User Testing stages; and
- 758     ▪ to allow for an early identification of issues and corrective measures for their resolution.

759 Both the Connected NCB and the Eurosystem provide progress updates for assessing the progress  
760 for the current stage of User Testing. The Eurosystem progress update includes any general  
761 testing risks and issues encountered that may affect the NCB's timely completion of User Testing  
762 stage. The Connected NCB reports on its progress against its test plan and reports any risks and  
763 issues that may affect its timely completion of the testing stage. When the progress update is  
764 shortly before the stage transition, then the Eurosystem uses the progress update as input for User  
765 Testing stage transition assessment.

766 When there is sufficient time remaining before the User Testing stage transition assessment, the  
767 Connected NCB and the Eurosystem assess the need for corrective actions to resolve any  
768 identified issues and mitigate any identified risks. Both the Connected NCB and the Eurosystem  
769 determine whether the implementation of the corrective measures is feasible and undertake their  
770 respective actions. If there is disagreement of the corrective actions, then the Connected NCB,  
771 the Eurosystem or both can initiate the escalation process.

# Currency Participation Agreement

## Schedule 3 – User Testing

### 7.2 User Testing Stage Transition Assessment Process

User Testing Stage Transition Assessment Process (T2S.UT.S3.020)

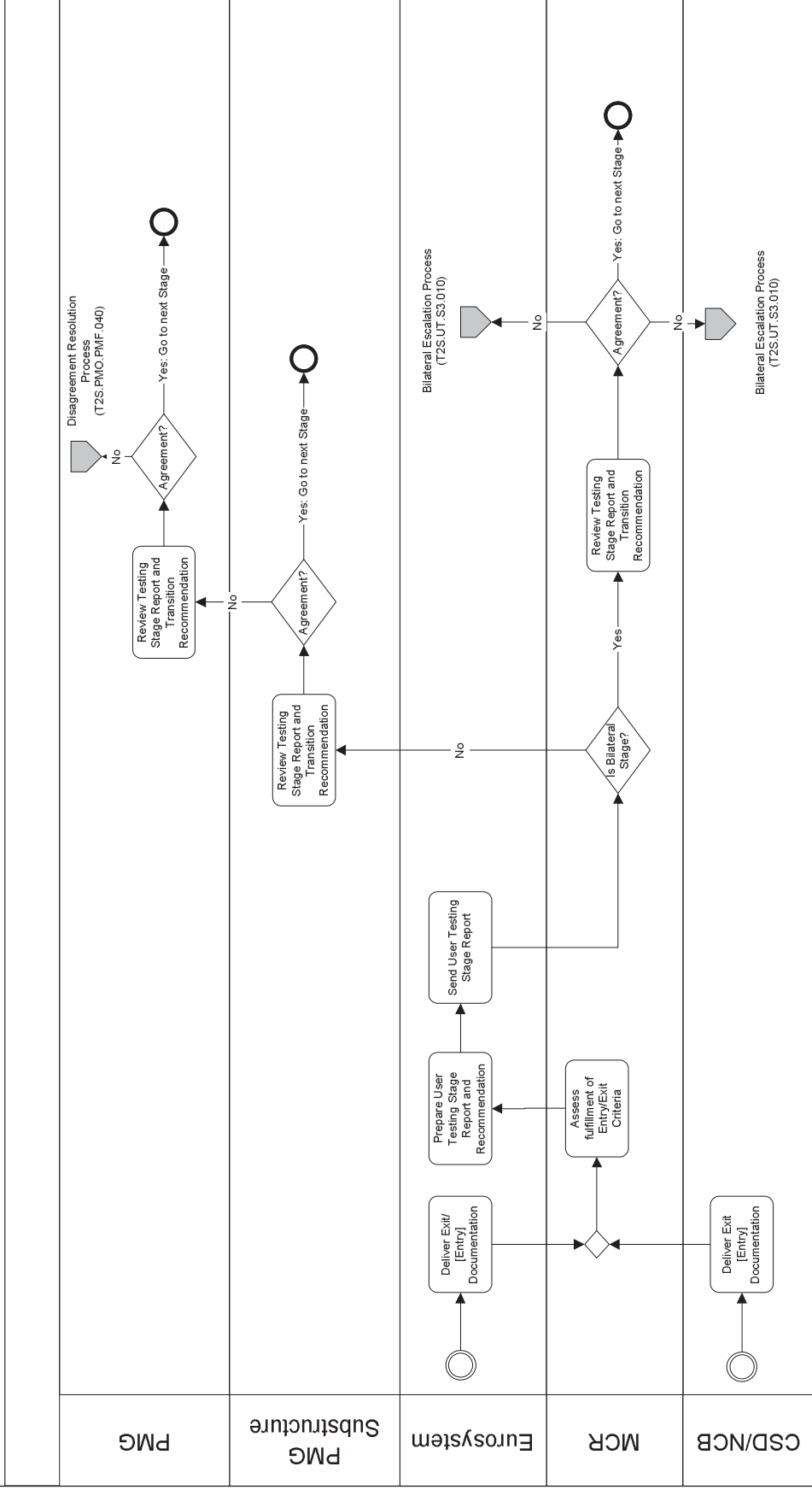

772

773



# Currency Participation Agreement

## Schedule 3 – User Testing

---

### 774 7.2.1 Process Actors and their Roles

Process Actor	Process Role
CSD / NCB	<p>In this process, the Connected NCB is responsible for:</p> <ul style="list-style-type: none"><li>▪ Providing a sufficient level of documentation to the Eurosystem to allow the Eurosystem to assess the Connected NCB's fulfilment of the entry and exit criteria for a testing stage;</li><li>▪ Carrying out an assessment of its own fulfilment of the entry and exit criteria for a testing stage;</li><li>▪ Assessing the proposed correction actions from the bilateral escalation process.</li></ul>
Eurosystem	<p>In this process, the Eurosystem is responsible for:</p> <ul style="list-style-type: none"><li>▪ Delivering the documentation to the Connected NCB to allow the Connected NCB to assess the Eurosystem's fulfilment of the entry / exit criteria for a testing stage;</li><li>▪ Carrying out an assessment of the its own fulfilment of the entry or exit criteria for a testing stage;</li><li>▪ Assessing the proposed corrective actions; and</li><li>▪ Drafting, agreeing and finalising the User Testing stage transition assessment report.</li></ul>
Monitoring of Client Readiness (MCR)	<p>In this process, the MCR has the obligation to:</p> <ul style="list-style-type: none"><li>▪ Monitor the Connected NCB's progress in order to determine whether it has fulfilled the entry or exit criteria for a testing stage;</li><li>▪ Propose and discuss corrective actions in case of non fulfilment of either the exit or entry criteria for a User Testing Stage; and</li><li>▪ Provide guidance to the PMG substructure when required in the case of multilateral escalation.</li></ul>
PMG Substructure	<p>In this process, the PMG substructure is responsible for:</p> <ul style="list-style-type: none"><li>▪ Discussing the stage transition assessment report and any recommendations;</li><li>▪ Providing the final decision during PMG substructure sessions to go forward to the next stage or into multilateral escalation in case of disagreement.</li></ul>
Project Managers Group (PMG)	<p>In this process, the PMG is responsible for resolving any potential disagreement on the decision to go forward to the next stage or to initiate the disagreement resolution process.</p>

775

776

# Currency Participation Agreement

## Schedule 3 – User Testing

---

### 777 7.2.2 Process Description

778 The assessment process for User Testing stage transition defines the steps in assessing and  
779 reporting on whether the Eurosystem, CSDs and NCBs are prepared to transition jointly from one  
780 stage of User Testing to the next based on the exit criteria of the current stage and/or the entry  
781 criteria of the next stage.

782 The Eurosystem provides to the Connected NCB the templates based on which the Connected  
783 NCB assesses its fulfilment of the exit criteria of the current stage of User Testing or/and the  
784 entry criteria for the next stage of User Testing. The Connected NCB assesses its fulfilment of  
785 the exit and/or entry criteria for User Testing stages. The Connected NCB and the Eurosystem  
786 jointly review this assessment as part of the monitoring of client readiness to determine whether  
787 the Connected NCB has fulfilled the applicable exit and/or entry criteria. Should an exit or entry  
788 criteria remain unmet, then the Connected NCB and the Eurosystem identify and assess  
789 corrective actions on the part of the Connected NCB, the Eurosystem or both parties, depending  
790 on the source and required resolution of the issue.

791 The Eurosystem prepares the User Testing stage transition assessment report that documents  
792 whether the Connected NCBs of a migration wave have fulfilled the exit criteria of the current  
793 stage of User Testing or/and the entry criteria for the next stage of User Testing. It documents  
794 recommendations for corrective actions should exit or entry criteria remain unfulfilled.

795 If the User Testing stage transition is bilateral, then the Eurosystem provides the report to the  
796 Connected NCB for assessment and both parties agree in the MCR whether there is a need to  
797 report risks and issues multilaterally. If the Connected NCB and the Eurosystem agree on the  
798 report's conclusions for a stage transition, then the Connected NCB formally enters the next  
799 testing stage. If no stage transition is possible or disagreements remain, then the MCR escalates  
800 the disagreement as defined in Section 7.3 on bilateral escalation process.

801 If the User Testing stage transition is multilateral, then the Eurosystem provides the report to the  
802 PMG substructure. If the PMG substructure agrees on the report's conclusions for a stage  
803 transition, then the Connected NCBs of a migration wave formally enter the next testing stage as  
804 a whole. If no stage transition is possible or disagreements remain, then the PMG substructure  
805 escalates the disagreement to the PMG. The PMG is responsible for resolving the potential  
806 disagreement on the decision to go forward to the next stage of User Testing. If it cannot reach an  
807 agreement, then it initiates the disagreement resolution process of Schedule 2 (T2S Programme  
808 Planning and Monitoring).

**Currency Participation Agreement**  
**Schedule 3 – User Testing**

**7.3 User Testing Stage Transition Bilateral Escalation Process**

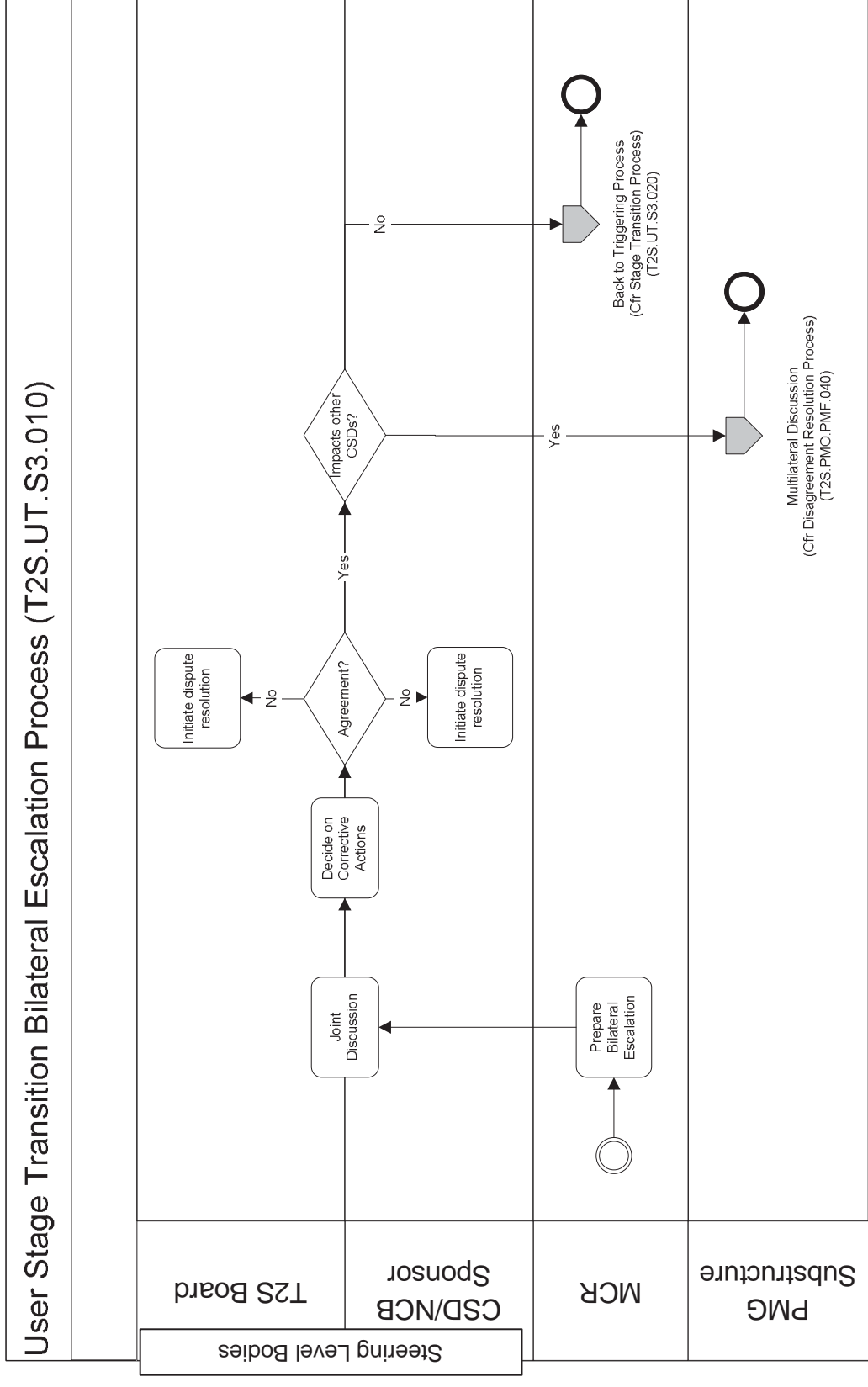

# Currency Participation Agreement

## Schedule 3 – User Testing

---

### 811 7.3.1 Process Actors and their Roles

Process Actor	Process Role
T2S Board	In this process, the T2S Board has the responsibility to discuss the escalated issue and attempt to find a resolution with the CSD / NCB Sponsor.
CSD/NCB Sponsor	In this process, the CSD/NCB Sponsor has the responsibility to discuss the escalated issue and attempt to find a resolution with the T2S Board.
Monitoring of Client Readiness (MCR)	In this process, the MCR prepares the bilateral escalation for the T2S Board and the CSD/NCB Sponsor.
PMG substructure	The PMG substructure is responsible for discussing and proposing solutions for a bilateral issue that affects multiple stakeholders and the successful delivery of T2S.

### 812 7.3.2 Process Description

813 The objective of this process is to resolve bilateral disagreements between the Eurosystem and  
814 the Connected NCB in the User Testing Phase. An example of such a disagreement would be  
815 differing assessments on whether the Connected NCB has fulfilled the entry or exit criteria for a  
816 specific stage of User Testing. The monitoring of client readiness identifies and raises any issues  
817 on User Testing that it cannot resolve to the Connected NCB's Sponsor and the T2S Board. At  
818 Steering Level, the Connected NCB's Sponsor and the T2S Board will attempt to resolve these  
819 disagreements with the objective to avoid entering the disagreement resolution process of  
820 Schedule 2.

821 The Steering Level will attempt to resolve the disagreement in a timely manner, taking into  
822 account the urgency and the severity of the matter. If the Steering Level has achieved agreement  
823 on the disputed issues and the proposed resolution does not affect other T2S Stakeholders, then it  
824 submits its resolution to the Connected NCB and the Eurosystem representatives in MCR for  
825 implementation. If the Steering Level has achieved agreement on the disputed issues and the  
826 proposed resolution affects other T2S Stakeholders, then it submits its resolution to the PMG  
827 substructure for review and a recommendation on its implementation. If ultimately the Steering  
828 Level cannot reach an agreement on the resolution of an issue, then it can escalate the issue  
829 according to disagreement resolution process of Schedule 2 (T2S Programme Planning and  
830 Monitoring).

# Currency Participation Agreement

## Schedule 3 – User Testing

831

### 7.4 User Testing Suspension Process

#### User Testing Suspension Process (T2S.UT.S3.030)

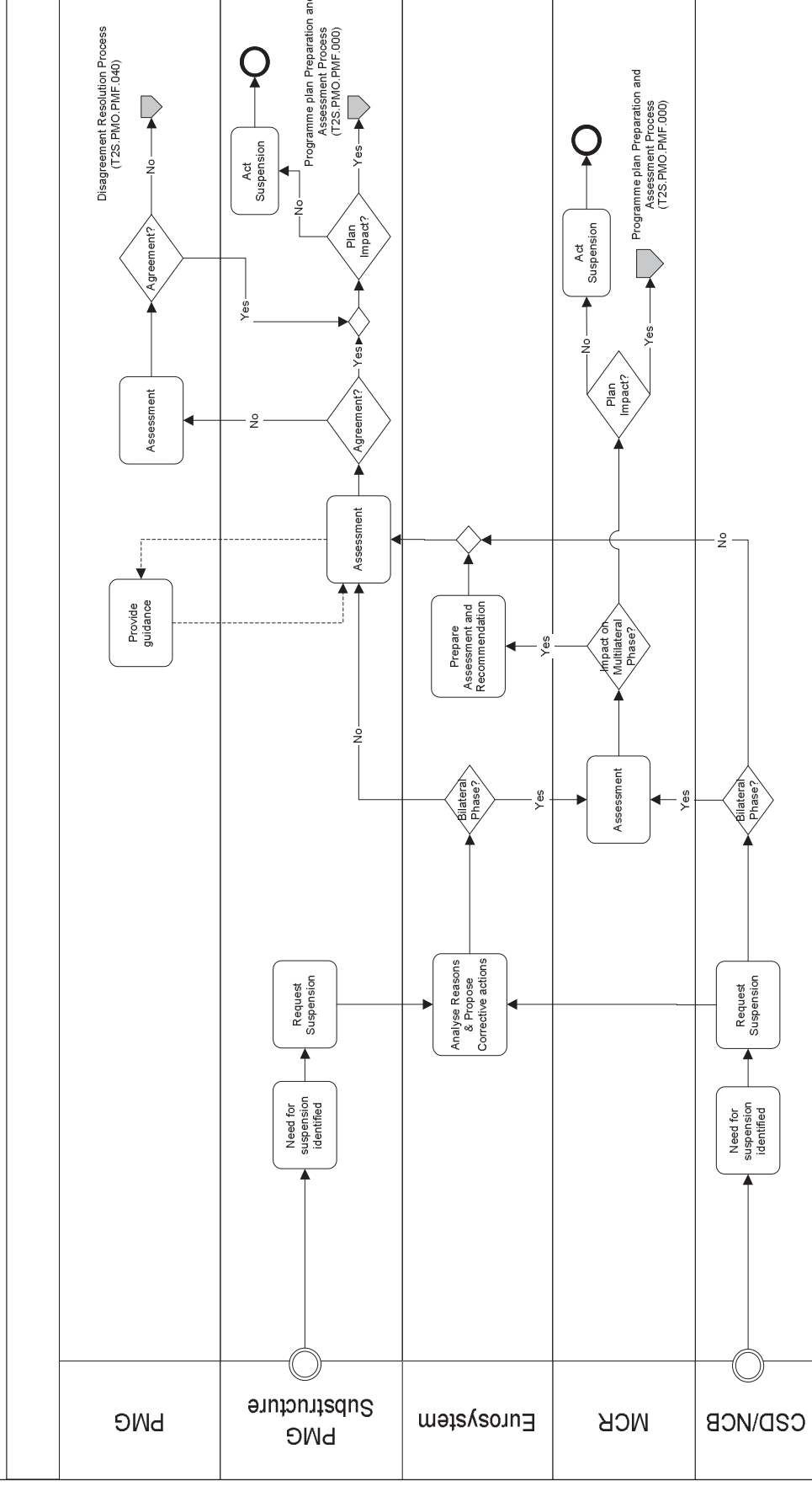

832

# Currency Participation Agreement

## Schedule 3 – User Testing

---

### 833 7.4.1 Process Actors and their Roles

Process Actor	Process Role
CSD / NCB	The CSD or NCB is responsible for identifying the need to and issuing the request to suspend User Testing.
Eurosystem	The Eurosystem has the responsibility for: <ul style="list-style-type: none"><li>▪ Analysing the CSD or NCB request to suspend User Testing;</li><li>▪ Proposing corrective measures to avoid a suspension of User Testing; and</li><li>▪ Preparing the assessment of and a recommendation on the suspension request.</li></ul>
Monitoring of Client Readiness (MCR)	In this process, the MCR depicts the bilateral steps of this process for: <ul style="list-style-type: none"><li>▪ Reviewing and discussing the status of User Testing; and</li><li>▪ Assessing the status of User Testing and providing guidance to the PMG substructure when required in the case of multilateral escalation.</li></ul>
PMG substructure	In this process, the PMG substructure is responsible for: <ul style="list-style-type: none"><li>▪ Discussing the stage transition assessment report and any recommendations; and</li><li>▪ Providing the final decision during PMG substructure sessions to go forward to the next stage or into multilateral escalation in case of disagreement.</li></ul>
Project Managers Group (PMG)	The PMG provides guidance to the PMG substructure in order to resolve disagreements on the potential suspension of User Testing. If the PMG substructure cannot reach an agreement, then the PMG is responsible for resolving any potential disagreement on the decision to suspend or for initiating the disagreement resolution process.

### 834 7.4.2 Process Description

835 This process describes the steps in taking a decision on a request from a Participating CSD or  
836 Participating NCB to suspend the current stage of User Testing. Participating CSDs/NCBs  
837 individually or the PMG substructure may identify the need to suspend User Testing, e.g. too  
838 many unresolved defects of various severities to allow the continuation of proper testing. The  
839 individual Participating CSD/NCB or the PMG substructure submits the request with its business  
840 justification to suspend User Testing to the Eurosystem.

841 The Eurosystem analyses the suspension request and, when possible to avoid the suspension to  
842 User Testing, proposes corrective action

- 843 ▪ To the individual Participating CSD/NCB that initiated the request when the request is  
844 bilateral; and

# Currency Participation Agreement

## Schedule 3 – User Testing

---

845       ▪ To the PMG substructure when it initiated the request as a multilateral request.

846   When the suspension request is bilateral, then

847       ▪ the Participating CSD/NCB jointly reviews the Eurosystem assessment of the suspension  
848       request in MCR; and

849       ▪ the Participating CSD/NCB and/or Eurosystem implement(s) any identified corrective  
850       actions to limit and/or avoid a suspension of User Testing.

851   If the suspension of User Testing is unavoidable and has no planning impact, then the MCR may  
852   initiate the suspension. If the suspension of User Testing is unavoidable and has a planning  
853   impact, then the MCR initiates an assessment of the planning impact that follows the programme  
854   plan preparation and assessment process in Schedule 2 (T2S Programme Planning and  
855   Monitoring).

856   When the suspension request is multilateral or the bilateral request has a multilateral impact, then  
857   Eurosystem prepares the assessment and recommendation for the assessment in the PMG  
858   substructure. The PMG substructure may request guidance from the PMG to facilitate a decision  
859   on the potential suspension of User Testing. In the case that the PMG substructure cannot reach  
860   an agreement, it may revert to the PMG to reach an agreement. If the PMG substructure cannot  
861   reach an agreement on the decision to suspend, then it initiates the disagreement resolution  
862   process as defined in Schedule 2 (T2S Programme Planning and Monitoring).

863   If the PMG substructure reaches an agreement on the request and the request has no planning  
864   impact, then the PMG substructure may initiate the suspension. If the suspension of User Testing  
865   is unavoidable and has a planning impact, then the PMG substructure initiates an assessment of  
866   the planning impact that follows the programme plan preparation and assessment process in  
867   Schedule 2 (T2S Programme Planning and Monitoring).

### 868   **7.5   Release management during the User Testing**

869   The Release Management Process (RMP) during the User Testing execution phase ensures that  
870   all aspects, technical and non-technical, originating from defects resolution are considered  
871   together, following the principles laid down in Chapter 5 of Schedule 9 (Change and Release  
872   Management). The PMG substructure makes a recommendation to the PMG on packaging the  
873   bug fixes in a bug fix release.

# Currency Participation Agreement

## Schedule 3 – User Testing

---

874 **7.6 Supporting processes**

875 **7.6.1 IT Service Management processes**

876 As described in chapter 3.1 it is the Eurosystem's responsibility to establish and operate the  
877 necessary IT service management processes that includes a defect resolution to remedy errors  
878 based on the principles of ITIL V3 Service Operation.

879 The details of these IT service management processes such as the defect resolution and incident  
880 handling will be described in the Manual of Operational Procedures (MOP). The MOP will  
881 describe these processes for T2S Operations and the Operations Managers Group (OMG) will be  
882 the main stakeholder in this processes. During User Testing the same processes will apply with  
883 one major distinction namely that the PMG substructure will be the main stakeholder instead of  
884 the OMG. Furthermore, the definitions of the severity of defect and the incident resolution times  
885 applicable during User testing are defined in Schedule 6 (T2S Service Level Agreement).

886



# Currency Participation Agreement

## Schedule 3 – User Testing

---

### 887 **8 Post-migration testing**

888 Post-migration testing shall refer to all testing activities of CSDs, NCBs, DCA Holders and  
889 Directly Connected Parties (DCPs) after go-live of the final migration wave for the initial release  
890 of T2S. Events, such as the migration of a new CSD / NCB to T2S or the implementation of a  
891 new release, will require post-migration testing.

892 The following principles shall apply for Post-Migration Testing:

893       ▪ The Project Managers Group (PMG) shall perform an impact assessment for a new T2S  
894       release or a new NCB joining on the T2S Actors in order to determine whether all T2S  
895       Actors will need to carry out User Testing for the T2S release or whether only affected  
896       T2S Actors need to test.

897       ▪ Based on the impact assessment, the Project Managers Group (PMG) with the support of  
898       the PMG substructure on User Testing shall propose a post-migration test plan to the  
899       Steering Level for approval.

900       ▪ The post-migration test plan must ensure that CSDs, NCBs, DCPs, DCA Holders will  
901       have sufficient time to verify that the delivered T2S functionality according to the agreed  
902       requirements and specifications.

903       ▪ Post-migration testing shall use the framework as defined in this Schedule.

904 The PMG in their impact assessment will make a recommendation to the Steering Level on  
905 whether the introduction of the new T2S release will require the recertification of CSDs and/or  
906 NCBs. The T2S Board shall take the final decision on whether CSDs and/or NCBs must recertify  
907 themselves for a new release of T2S.

908

# Currency Participation Agreement

## Schedule 3 – Annex 1 – Mapping of testing activities on the test environments

---

### 909 **Annex 1 – Mapping of testing activities on the test environments**

910 In accordance with the principles for sharing testing facilities, the Eurosystem will not plan any  
911 Eurosystem Acceptance Testing activity on the testing environments used for User Testing.

912 The following diagram presents the mapping of the testing activities for each migration wave on  
913 the test environments.

914

# Currency Participation Agreement

Schedule 3 – Annex 1 – Mapping of testing activities on the test environments



*Disclaimer: the timeline is only used to illustrate the usage of the test environments.*

# Currency Participation Agreement

## Schedule 3 – Annex 1 – Mapping of testing activities on the test environments

931

932

933

934

935

936

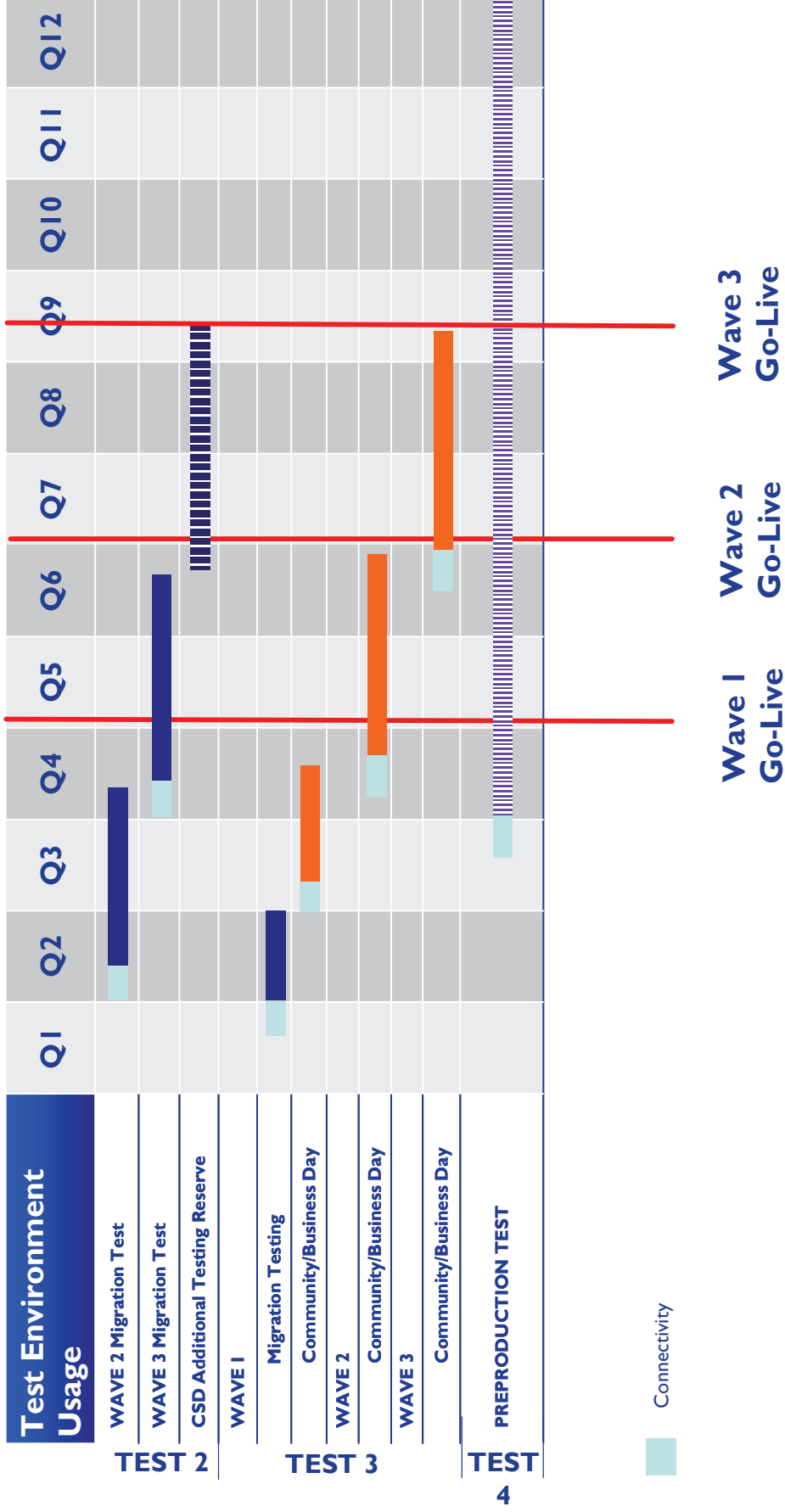



# **CURRENCY PARTICIPATION AGREEMENT**

## **SCHEDULE 4**

### **MIGRATION**

# Currency Participation Agreement

## Schedule 4 –Migration

---

### Table of contents

<b>1 Introduction .....</b>	<b>1</b>
<b>2 Objective, scope and approach of the migration schedule.....</b>	<b>2</b>
2.1 Objective.....	2
2.2 Scope .....	2
2.3 General migration approach.....	2
<b>3 General responsibilities of the Contracting Parties.....</b>	<b>4</b>
3.1 General responsibilities of the Eurosystem .....	4
3.2 General responsibilities of the Connected NCB .....	5
3.3 Cooperation and escalation procedures .....	7
<b>4 Preparation of the migration .....</b>	<b>9</b>
4.1 Responsibilities of the Eurosystem.....	9
4.2 Responsibilities of the Connected NCB .....	11
<b>5 Implementation of the migration .....</b>	<b>12</b>
5.1 Responsibilities of the Eurosystem.....	12
5.2 Responsibilities of the Connected NCB .....	13
<b>6 Closing phase.....</b>	<b>15</b>
6.1 Responsibilities of the Eurosystem.....	15
6.2 Responsibilities of the Connected NCB .....	15
<b>ANNEX 1: Migration milestones.....</b>	<b>1</b>

# Currency Participation Agreement

## Schedule 4 –Migration

---

### 1 1 Introduction

2 This document aims at presenting the provisions related to the framework that will be used to prepare  
3 and conduct the migration to T2S of the Connected NCBs and their Dedicated Cash Accounts  
4 holders, as well as the roles and responsibilities of the contracting parties along the migration process  
5 from the preparation phase until the end of the Migration Period.

6 The document is divided into five chapters, corresponding to the major aspects identified as relevant  
7 for the migration framework: i) objective, scope and approach of the migration schedule; ii) general  
8 responsibilities of the contracting parties; iii) preparation of the migration, iv) implementation of the  
9 migration and v) closing phase.

# Currency Participation Agreement

## Schedule 4 – Migration

---

### 10 2 Objective, scope and approach of the migration schedule

#### 11 2.1 Objective

12 The objective of the T2S migration is to enable a smooth and successful transition to the usage of the  
13 T2S Services for all Connected NCBs and their Dedicated Cash Account holders once the pre-  
14 requisites for their migration are fulfilled. As stated in the User Requirements Document, “*Migration*  
15 *in the context of T2S means the relocation of data from a CSD to the T2S infrastructure and the*  
16 *associated changes in the processes and technical environment of a CSD on a mutually agreed date*”.  
17 Obviously, the same applies to the Connected NCBs to ensure a successful migration to T2S on the  
18 agreed date.

#### 19 2.2 Scope

20 In terms of activities, the scope of this Migration Schedule covers all activities that are related to the  
21 preparation of the T2S production environment for the successful migration of a Connected NCB and  
22 its Dedicated Cash Account holders. Chapter 4, 5 and 6 provide the relevant information concerning  
23 the migration related activities. Although the migration process is interrelated with others processes,  
24 in particular the User Testing until the end of the Migration Period, the T2S Programme Plan and the  
25 Release Management during the Migration Period (if releases/ software updates are envisaged during  
26 this period), such other activities will be described separately in the relevant Schedules.

27 With regards to the users, in the context of the Currency Participation Agreement the T2S migration  
28 perimeter consists of all non-euro area NCBs that have entered into a contractual relationship with  
29 the Eurosystem for the use of T2S in view of their connection to T2S during the Migration Period.  
30 Whenever relevant, references will be made to co-ordination of migration activities with other T2S  
31 Actors, but the actual provisions applicable to those T2S Actors will be covered as part of the legal  
32 relationship with these T2S Actors.

#### 33 2.3 General migration approach

34 The migration to T2S will follow a phased approach and will be organised to reach the following  
35 objectives:

- 36     ▪ give the necessary flexibility for the planning and coordination of the migration activities;



# Currency Participation Agreement

## Schedule 4 – Migration

---

- 37       ▪ allow for a gradual build-up of volumes;
- 38       ▪ mitigate the risk that any Connected NCB fails to successfully migrate to T2S on the agreed  
39       date, thereby avoiding interruptions in the Connected NCB’s business;
- 40       ▪ ensure system stability from a functional and technical perspective throughout the migration  
41       process.

42 This phased approach will be implemented via a migration “by CSD” approach, which allows the  
43 CSDs and their Users to migrate to T2S in different waves and on different pre-defined dates.

44 The migration will be organised targeting a maximum number of 4 migration waves<sup>1</sup>, with a  
45 minimum period of 3 months between each wave. In addition, one contingency migration date is  
46 available (not later than 6 months after the date of the last migration wave), to be used in case the  
47 CSD and/or Connected NCB cannot migrate as originally committed. The contingency migration  
48 wave can be used by a Connected NCB provided that an agreement has been reached with its  
49 national CSD(s)<sup>2</sup> with respect to the fact that the migration can not take place as originally scheduled  
50 and therefore the migration of the Connected NCB and of its national CSD(s) has to be deferred to  
51 the contingency wave.

52 The duration of the migration shall be limited to 18 months, from the T2S Go-Live Date (i.e. date of  
53 the first migration wave) until the contingency migration date.

54 The Connected NCB shall migrate at the latest in the migration wave in which at least one national  
55 CSD migrates to T2S. The migration will take place during a weekend and will be driven by  
56 settlement date. The migration to T2S will not take place on a “sensitive” weekend during critical  
57 periods for CSDs and Connected non-euro CBs such as corporate action season, freeze periods or  
58 periods of significant market stress etc.

---

<sup>1</sup> The fourth migration wave is optional pending the proposal of the CSDs by synchronisation point 2 as defined in Schedule 2 (i.e. Q2 2011)

<sup>2</sup> A CSD located in the country of the Connected NCB

# Currency Participation Agreement

## Schedule 4 – Migration

---

### 59 3 General responsibilities of the Contracting Parties

60 As an overarching principle, the Eurosystem and the Connected NCB shall cooperate in good faith  
61 for the preparation and execution of all T2S migration activities.

#### 62 3.1 General responsibilities of the Eurosystem

63 In view of preparing and ensuring a successful migration to T2S of all Connected NCBs and their  
64 Dedicated Cash Account holders, the Eurosystem shall:

- 65 a) cooperate in good faith with the Connected NCBs and the other T2S Actors and provide  
66 them with all relevant information to prepare the necessary procedures and processes for all  
67 migration activities and related deliverables, as described in Schedule 2 (T2S Programme  
68 Planning and Monitoring);
- 69 b) coordinate, steer and monitor the T2S migration process. In co-operation with the Connected  
70 NCBs, it establishes the migration plan, the tasks and the milestones for the migration  
71 process and monitors compliance with the agreed procedures and milestones;
- 72 c) prepare the life-cycle of the migration process which consists of three phases: (i) the  
73 planning phase, which consists of activities related to the preparation of the migration  
74 activities that need to be planned in advance in order to mitigate the migration risks; (ii) the  
75 implementation phase, which consists of the actual preparations for live operations and (iii)  
76 the closing phase, which consists of preparing closing reports aiming at improving the next  
77 migration based on lessons learned from the initial migration. The diagram outlining the  
78 sequence and interrelations of the migration activities, as well as the milestones of the T2S  
79 migration phases are presented in Annex 1 (Migration milestones) to this Schedule;
- 80 d) set up a PMG substructure, which will be in charge of coordinating, supporting and  
81 monitoring the work related to the migration activities, in accordance with the T2S  
82 Governance and the provisions set out in section 3.3 of this Schedule;
- 83 e) nominate one person for each Connected NCB as migration correspondent for that non-euro  
84 area NCB, as well as a T2S migration coordinator in charge of monitoring and coordinating  
85 all activities to be carried out during the migration process;
- 86 f) ensure the readiness of the production environment according to the provisions of Schedule 2  
87 (T2S Programme Planning and Monitoring) in order to enable the Connected NCBs to plan  
88 and carry out all activities on the production environment required for its migration to T2S;

## Currency Participation Agreement

### Schedule 4 – Migration

---

- 89 g) ensure the readiness of T2S for all migration waves, meaning that the enhancements to the  
90 system are reduced to the resolution of blocking and severe defects discovered during the  
91 Migration Period;
- 92 h) provide all reasonable support to Connected NCBs in ensuring the readiness of the Dedicated  
93 Cash Accounts in their currency, prior to the first settlement of securities transactions by  
94 their national CSDs. The opening of these Dedicated Cash Accounts will be driven by the  
95 request of the Dedicated Cash Account holders in accordance with the rules and conditions  
96 set up by the Connected NCB;
- 97 i) upload and maintain the necessary Central Bank Static Data and system configuration  
98 parameters sufficiently in advance of the migration of the Connected NCBs; The Central  
99 Bank Static Data will be created upfront with a future “valid from” date;
- 100 j) provide support to the Connected NCB – in particular in accordance with section 21.8 of the  
101 URD – for the transfer of its Central Bank Static Data and the Dynamic Data prior to its  
102 migration to T2S;
- 103 k) report progress on the overall migration process on a regular basis and share relevant  
104 information with the Connected NCBs on their level of readiness (based on information  
105 provided by those Connected NCBs);
- 106 l) apply an escalation and decision-making process for any migration related issues in  
107 accordance with the general T2S governance arrangements, as specified in Schedule 8  
108 (Governance) and in the provisions set out in section 3.3 of this Schedule;
- 109 m) provide support to the Connected NCBs with regard to their migration activities, including  
110 during the process of “de-migration” of the Connected NCB in case the Connected NCB  
111 faces severe problems due to significantly degraded Service Level during the week after its  
112 migration to T2S;
- 113 n) provide training sessions for the migration to the Connected NCBs and all necessary support  
114 to facilitate the training sessions provided by the Connected NCBs to its Dedicated Cash  
115 Account holders.

### 116 3.2 General responsibilities of the Connected NCB

117 In view of preparing and ensuring a successful migration to T2S, the Connected NCBs shall:

- 118 a) cooperate in good faith with the Eurosystem and with other relevant T2S Actors and provide  
119 all relevant information to prepare the necessary procedures and processes for all migration  
120 activities and related deliverables, identified in Schedule 2 (T2S Programme Planning and

# Currency Participation Agreement

## Schedule 4 – Migration

---

- 121 Monitoring);
- 122 b) determine, in agreement with its national CSD(s) , the migration wave in which it shall  
123 migrate to T2S and the respective migration date by synchronisation point 2 as defined in  
124 Schedule 2 (i.e. Q2 2012);
- 125 c) migrate to T2S at the latest in the migration wave in which at least one national CSD  
126 migrates to T2S;
- 127 d) ensure its own readiness for the migration to T2S by the agreed date according to the  
128 procedures and processes agreed with the Eurosystem and other T2S Actors;
- 129 e) take all measures that are reasonably required to facilitate the readiness of its Dedicated Cash  
130 Account holders for the migration to T2S by the agreed date according to the procedures and  
131 processes agreed with the Eurosystem and other T2S Actors;
- 132 f) set up its own migration project, define its migration plan, allocate appropriate resources to  
133 the implementation of such a plan, as well as assess and adjust such migration plan and the  
134 allocated resources, where necessary, with a view to ensuring a smooth migration to T2S  
135 according to the agreed plan; the adjustments to migration plans must be discussed and  
136 agreed with the Eurosystem and other T2S Actors as changes may have an impact on all the  
137 involved parties;
- 138 g) be involved in the decision to go-live of T2S as a member of the coordination body in charge  
139 of coordinating, supporting and monitoring the work related to user testing activities,  
140 independently of its migration wave; in particular, the Connected NCB will be able to  
141 contribute to this coordination body<sup>3</sup> opinion whether or not the exit criteria for the business  
142 day testing are fulfilled and on the level of comfort that all remaining blocking and severe  
143 defects will be solved in time in order to avoid any impediments for the later migrating non-  
144 euro area NCBs;
- 145 h) ensure the readiness of the Dedicated Cash Accounts in its currency prior to the go-live of  
146 T2S (i.e. if the Connected NCB and at least one national CSD join T2S in the first migration  
147 wave) or prior to the first settlement of securities transactions by a national CSD (i.e. if the  
148 Connected NCB and its national CSD join T2S in a later migration wave). The Dedicated  
149 Cash Accounts in its currency shall be opened in T2S by the Connected NCB upon the  
150 request of the Dedicated Cash Account holders in accordance with the rules and conditions  
151 set up by the Connected NCB;

---

<sup>3</sup> If an agreement for a dispute cannot be reached at the level of this coordination body, the dispute resolution and escalation procedure described in art. Article 35 of the CPA applies and follows a decision-making process in accordance with the T2S Governance, as specified in Schedule 8.

## Currency Participation Agreement

### Schedule 4 – Migration

---

- 152 i) upload and maintain its Central Bank Static Data sufficiently in advance, typically with  
153 maximum three months before the migration of its national CSD (i.e. before the migration  
154 wave where the holders of the Dedicated Cash Accounts envisage to settle securities  
155 transactions in its currency); the Central Bank Static Data will be created upfront with a  
156 future “valid from” date;
- 157 j) ensure the availability of the necessary functions to provide T2S with the required collateral  
158 information as of the date of its migration if the Connected NCB decides to use auto-  
159 collateralisation functionality to offer intraday credit in T2S;
- 160 k) provide training sessions to its Dedicated Cash Account holders sufficiently in advance of  
161 community testing;
- 162 l) report progress on its readiness for migration according to the agreed procedures, frequency  
163 and level of detail, with a particular view to identifying developments that might jeopardise  
164 the migration of the other T2S Actors according to the agreed plan;
- 165 m) nominate one person for coordinating all migration activities within its own organisation and  
166 ensure that such person or an alternate shall duly and regularly participate in the meetings  
167 organised by the Eurosystem until the Connected NCB has migrated to T2S, and, in  
168 particular where this is not practicable, in the written procedures;

### 169 3.3 Cooperation and escalation procedures

170 The Eurosystem shall apply an escalation and decision-making process for communication in  
171 accordance with the general T2S governance arrangements, as specified in Schedule 8 (Governance).

172 The Eurosystem shall set up a PMG substructure, in accordance with the T2S governance, for the  
173 coordination and monitoring of the migration activities. This substructure shall meet on a regular  
174 basis and shall at least be composed of the ECB Migration coordinator, the 4CB Migration  
175 coordinator, and a Migration coordinator from each Connected NCB (as meant in section 3.2.m of  
176 this Schedule).

177 The role of the substructure in charge of Migration shall be to:

- 178 ▪ Coordinate and review Migration activities;
- 179 ▪ Monitor the implementation of the Migration plans;
- 180 ▪ Review the Connected NCB’s tailored Migration plan;
- 181 ▪ Discuss issues raised by the members of the substructure and try to resolve disagreements;

## Currency Participation Agreement

### Schedule 4 – Migration

---

182       ▪ Communicate with the T2S Programme management office on the planning of Migration  
183           activities;

184       ▪ Prepare communications related to migration to the various T2S Stakeholders and the public  
185           at large.

186 In case of an urgent issue requiring immediate action,, the following process shall be followed:

187       ▪ The Connected NCB shall request a conference call with the Eurosystem during the next  
188           business day or at its earliest convenience;

189       ▪ The issue shall be discussed during the conference call;

190       ▪ The Eurosystem shall summarize the outcome of the conference call and distribute it to the  
191           members of the substructure in charge of Migration.

192 The substructure in charge of Migration shall convene at its earliest convenience to:

193       ▪ Assess the nature of the issue;

194       ▪ Assess the impact of the issue on the various T2S Actors;

195       ▪ Assess any potential impact on the organisation and the timing of the migration activities for  
196           the various T2S Actors;

197       ▪ Prepare an action plan, and the necessary communication, if any, to address the issue;

198 In case no agreement can be reached in the substructure, each party shall be entitled to escalate the  
199 problem to the Project Managers Group (PMG), where the situation shall be discussed and rapidly  
200 assessed.

201 If a mutually agreeable solution cannot be found in the PMG, then the general T2S escalation process  
202 shall apply whereby the issue is escalated to the relevant T2S steering bodies in order to receive  
203 guidance to resolve the issue. The escalation process shall be in accordance with the general T2S  
204 governance arrangements, as specified in the Schedule 8 (Governance).

205 Ultimately there shall be recourse to the dispute resolution process as described in the provisions of  
206 the relevant Articles in the core Currency Participation Agreement.

# Currency Participation Agreement

## Schedule 4 – Migration

---

### 207 4 Preparation of the migration

208 The activities to be carried out for the preparation of the T2S Go-Live Date and the migration of a  
209 Connected NCB and its Dedicated Cash Account holders need to be well planned in advance in order  
210 to mitigate the risks related to the migration process.

#### 211 4.1 Responsibilities of the Eurosystem

212 In order to prepare and organise the migration related activities, the Eurosystem – in cooperation  
213 with the Connected NCB - shall:

- 214 a) set up a coordination body according to the T2S Governance and ensure that all Connected  
215 NCB and other T2S Actors are informed via this forum as to the progress of the migration  
216 activities;
- 217 b) set up a bilateral coordination structure between the Eurosystem and each Connected NCB in  
218 addition to the multilateral structure specified above;
- 219 c) establish the standard migration plan for all Connected NCBs that will join T2S, including  
220 aspects related to the set-up of Dedicated Cash Accounts, major project milestones, the  
221 necessary Dynamic Data to be input into the system, , as well as checkpoints to be met before  
222 the start of the migration weekend;
- 223 d) support the Connected NCB in establishing the tailored migration plan per Connected NCB  
224 or group of Connected NCBs depending on its specificities;
- 225 e) establish the detailed migration weekend script for each migration wave which provides the  
226 Connected NCB with the required information to execute the tasks and/or to carry out the  
227 actions required during the migration weekend;
- 228 f) establish the fall-back arrangements and roll-back procedures specific for each migration  
229 wave, in order to manage the necessary processes if the migration needs to be deferred to a  
230 later stage due to predictable or unforeseen circumstances, and/or if the activities already  
231 performed during the migration weekend need to be unwound if the migration has to be  
232 stopped;
- 233 g) provide support to the Connected NCB – in particular in accordance with section 21.8 of the  
234 URD – if it has been demonstrated, following the applicable crisis management  
235 arrangements, that there is a need to “de-migrate” to its legacy system immediately after its

## Currency Participation Agreement

### Schedule 4 – Migration

---

- 236 migration in case the Connected NCB faces severe problems at that time, either due to  
237 significantly degraded Service Levels, or because of severe problems at the Connected NCB  
238 itself;
- 239 h) define the registration guide/procedures in order to enable the Connected NCB to describe in  
240 detail their participation data, services used, account usage details;
- 241 i) establish the structure and elements of the migration profile for each Connected NCB which  
242 gives a structured overview of the set-up of Connected NCB on their first day of operation in  
243 T2S;
- 244 j) define the necessary Central Bank Static Data and Dynamic Data to be uploaded in the  
245 system, as well as the relevant message formats;
- 246 k) re-plan and reschedule certain migration activities as required, based on a strong coordination  
247 and decision-making process between the Eurosystem and the Connected NCB, in the  
248 eventuality that an unexpected event (within and out of the control of the Connected NCB)  
249 will impede the migration of one or more Connected NCBs on the scheduled date;
- 250 l) actively monitor throughout the migration process the level of the Connected NCB's  
251 preparedness;
- 252 m) prepare progress reports to the appropriate bodies on the status of each Connected NCB  
253 based on the information provided by the Connected NCBs according to pre-agreed  
254 dashboard indicators;
- 255 n) establish the communication framework for the migration process which covers the  
256 information exchanged with the Connected NCBs and the market about the migration  
257 process and about individual migrations. Communications will be prepared jointly by the  
258 Eurosystem and the Connected NCBs, in accordance with the provisions set out in the  
259 Currency Participation Agreement and in section 3.3 of this Schedule;
- 260 o) report progress on the activities carried out during the planning phase by the Eurosystem and  
261 the Connected NCBs according to the agreed procedures, frequency and level of detail, with  
262 a particular view to identifying aspects that might jeopardise the migration according to the  
263 agreed plan;
- 264 p) establish specific operational procedures and rules, if needed, to be followed by the  
265 Connected NCB during the Migration Period where some Contracting CSDs will operate  
266 under the new operational regime of T2S.
- 267



## Currency Participation Agreement

### Schedule 4 – Migration

---

#### 268 4.2 Responsibilities of the Connected NCB

269 In order to prepare and organise the migration related activities, the Connected NCB – in cooperation  
270 with the Eurosystem - shall:

- 271 a) organize, prepare and monitor its own migration process and take appropriate measures in  
272 order to ensure its own readiness and that of its Dedicated Cash Account holders for joining  
273 T2S;
- 274 b) monitor and take all measures that are reasonably required to facilitate the readiness of its  
275 Dedicated Cash Account holders for the migration to T2S;
- 276 c) cooperate with the Eurosystem in preparation of the standard migration plan and the detailed  
277 migration weekend script;
- 278 d) develop its tailored migration plan (including a fallback plan) based on the standard  
279 migration plan;
- 280 e) coordinate the readiness of its Dedicated Cash Account holders for migration to T2S. The  
281 Connected NCB shall take all measures that are reasonably required to facilitate the readiness  
282 of the Dedicated Cash Accounts of its participants in T2S i.e. the creation and availability of  
283 Dedicated Cash Accounts in T2S prior to the first settlement of the securities transactions by  
284 its national CSD;
- 285 f) identify any “critical participants” from a cash perspective that might jeopardize the  
286 migration of the relevant Connected NCB and its Dedicated Cash Account holders and  
287 involve them actively in the migration project, monitoring their preparations more closely  
288 and possibly envisaging fallback arrangements to settle their transactions;
- 289 g) communicate the readiness of the Dedicated Cash Accounts, as well as the decision on the  
290 readiness of the Dedicated Cash Account holders to operate their Dedicated Cash Accounts  
291 in T2S to its Dedicated Cash Account holders well in advance in order to allow them to  
292 organise their migration;
- 293 h) report progress to the Eurosystem on the activities carried out during the planning phase  
294 according to the agreed procedures, frequency and level of detail, with a particular view to  
295 identifying developments that might jeopardise the migration of the other T2S Actors  
296 according to the agreed plan;.

# Currency Participation Agreement

## Schedule 4 – Migration

---

### 297 **5 Implementation of the migration**

298 The implementation phase consists of the actual preparations for live operations and the execution of  
299 the tasks on the T2S production environment, in particular all activities that need to be carried out  
300 from the moment when the Eurosystem has made the T2S production environment available to the  
301 Connected NCBs until the successful migration of the last Connected NCB.

#### 302 **5.1 Responsibilities of the Eurosystem**

303 Prior to the start of the implementation phase, the Eurosystem shall:

- 304 a) confirm the readiness of the T2S production environment, including the system's compliance  
305 with specific non-functional requirements, in particular related to technical performance,  
306 business continuity and information;
- 307 b) make available to the Connected NCBs the versions of all the functional and operational  
308 documentation (e.g. GFS, UDFS, User Handbooks, Manual of Operational Procedures),  
309 which are compliant with the T2S production environment and/or will be used for live  
310 operations according to Schedule 2 (T2S Programme Planning and Monitoring);
- 311 c) set up coordination bodies, in accordance with the T2S governance, for the coordination and  
312 monitoring of the activities to be carried out from the moment when the Eurosystem has  
313 made the T2S production environment available to the Connected NCB until the successful  
314 migration of the last Connected NCB and the other T2S Actors, as well as for the decision-  
315 making in case an incident occurs which might jeopardise the migration to T2S.

316 During the implementation phase, the Eurosystem shall:

- 317 a) carry out all the pre-migration activities and the activities required during the migration  
318 weekend, according to the agreed plan;
- 319 b) ensure prior to the T2S Go-Live Date that the complete T2S functionality is available in the  
320 T2S production environment and all critical bugs encountered during the User Testing have  
321 been corrected, so as to avoid the implementation of functional releases during the Migration  
322 Period;
- 323 c) confirm – prior to the start of first migration wave and the subsequent migration waves - the  
324 correct functioning of the T2S production environment according to the T2S Scope Defining  
325 Set of Documents and other relevant documents, including the successful execution of an

## Currency Participation Agreement

### Schedule 4 – Migration

---

- 326 inter-region rotation before the first and second migration wave and that the conditions  
327 agreed during the previous Go/ No go decision are met;
- 328 d) upload and maintain the necessary Central Bank Static Data and configuration parameters  
329 sufficiently in advance of the migration of the Connected NCB; these data will be created  
330 upfront with a future “valid from” date;
- 331 e) confirm the start of the activities during the migration weekend and subsequently the  
332 successful completion of each migration on the basis of a report prepared in collaboration  
333 with the Connected NCBs; The former confirmation will only be given, in particular, if the  
334 exit criteria of the User Testing have been successfully completed and a timetable for  
335 implementation of the corrections for the remaining severe defects has been mutually agreed  
336 with the Connected NCBs;
- 337 f) provide support to the Connected NCB for the transfer of its Central Bank Static and  
338 Dynamic Data prior to migration of the Connected NCB to T2S;
- 339 g) report progress on the activities carried out during the implementation phase by the  
340 Eurosystem and the Connected NCBs according to the agreed procedures, frequency and  
341 level of detail, with a particular view to identifying aspects that might jeopardise the  
342 migration according to the agreed plan;
- 343 h) provide support to the Connected NCBs to perform the required actions for their successful  
344 migration according to agreed plan.

#### 345 **5.2 Responsibilities of the Connected NCB**

346 Prior to the start of the migration weekend i.e. go-live of T2S or any other migration date, the  
347 Connected NCB shall:

- 348 a) obtain the certification from the Eurosystem for uploading and maintenance of Central Bank  
349 Static Data on the T2S production environment, management of liquidity and collateral as a  
350 pre-condition to start any activities on the production environment;
- 351 b) establish and verify its connectivity to the T2S production environment for each of the  
352 networks selected by the Connected NCB;
- 353 c) upload and maintain the Central Bank Static Data sufficiently in advance, typically with  
354 maximum three months before the migration of its national CSD (i.e. before the migration  
355 wave where the holders of the Dedicated Cash Accounts envisage to settle securities  
356 transactions in its currency);

## Currency Participation Agreement

### Schedule 4 – Migration

---

- 357 d) verify and confirm that its internal systems and processes and those of its Dedicated Cash  
358 Account holders are ready to efficiently interact with T2S;
- 359 e) verify and confirm that T2S delivers the expected services as agreed in the T2S Scope  
360 Defining Set of Documents, in particular by having obtained the possibility to verify that all  
361 critical defects have been solved, including those discovered during the implementation  
362 phase;
- 363 f) confirm the availability of the necessary Dedicated Cash Accounts upon the request of the  
364 Dedicated Cash Account holders;
- 365 g) confirm the availability of the necessary functions to provide T2S with the required collateral  
366 information if the Connected NCB decides to use auto-collateralisation functionality to offer  
367 the intraday credit in T2S;
- 368 h) confirm that the T2S Scope Defining Documents and other T2S operational documentation  
369 are compliant with the services provided by the T2S and can be used for the live operations;
- 370 i) confirm its readiness for migration and that of its Dedicated Cash Account holders to T2S  
371 according to the agreed migration plan;
- 372 j) complete all required forms for the registration on the T2S production environment and  
373 provide them to the Eurosystem by the agreed time;
- 374 k) ensure timely access to relevant static data for its Dedicated Cash Account holders;
- 375 l) carry out all the required pre-migration activities according to the agreed migration plan.
- 376 During the migration weekend, the Connected NCB shall:
- 377 a) carry out all the activities required during the migration weekend according to the agreed  
378 migration plan, including the fall-back arrangements and roll-back procedures as specified in  
379 section 4.1 f) of this Schedule;
- 380 b) report on the status of the activities carried out during the migration weekend according to  
381 the agreed procedures, frequency and level of detail;
- 382 c) confirm the end of its migration based on the successful completion of the activities to be  
383 carried out during the migration weekend according to the agreed plan.

# Currency Participation Agreement

## Schedule 4 – Migration

---

### 384 **6 Closing phase**

385 The closing phase covers the final reporting and the assessment of the lessons learned during the  
386 migration process.

#### 387 **6.1 Responsibilities of the Eurosystem**

388 During the closing phase, the Eurosystem shall:

389 a) provide reports on lessons learned from a migration wave to be applied to the next migration  
390 waves;

391 b) ensure the necessary updates and improvements in the migration plans in order to smoothen  
392 the next migration waves.

#### 393 **6.2 Responsibilities of the Connected NCB**

394 During the closing phase, the Connected NCB shall provide feedback to the Eurosystem based on its  
395 experience gained during its migration in order to improve the migration of the next waves.

**Currency Participation Agreement**  
**Schedule 4 – Annex 1 – Migration milestones**

**ANNEX 1: Migration milestones**

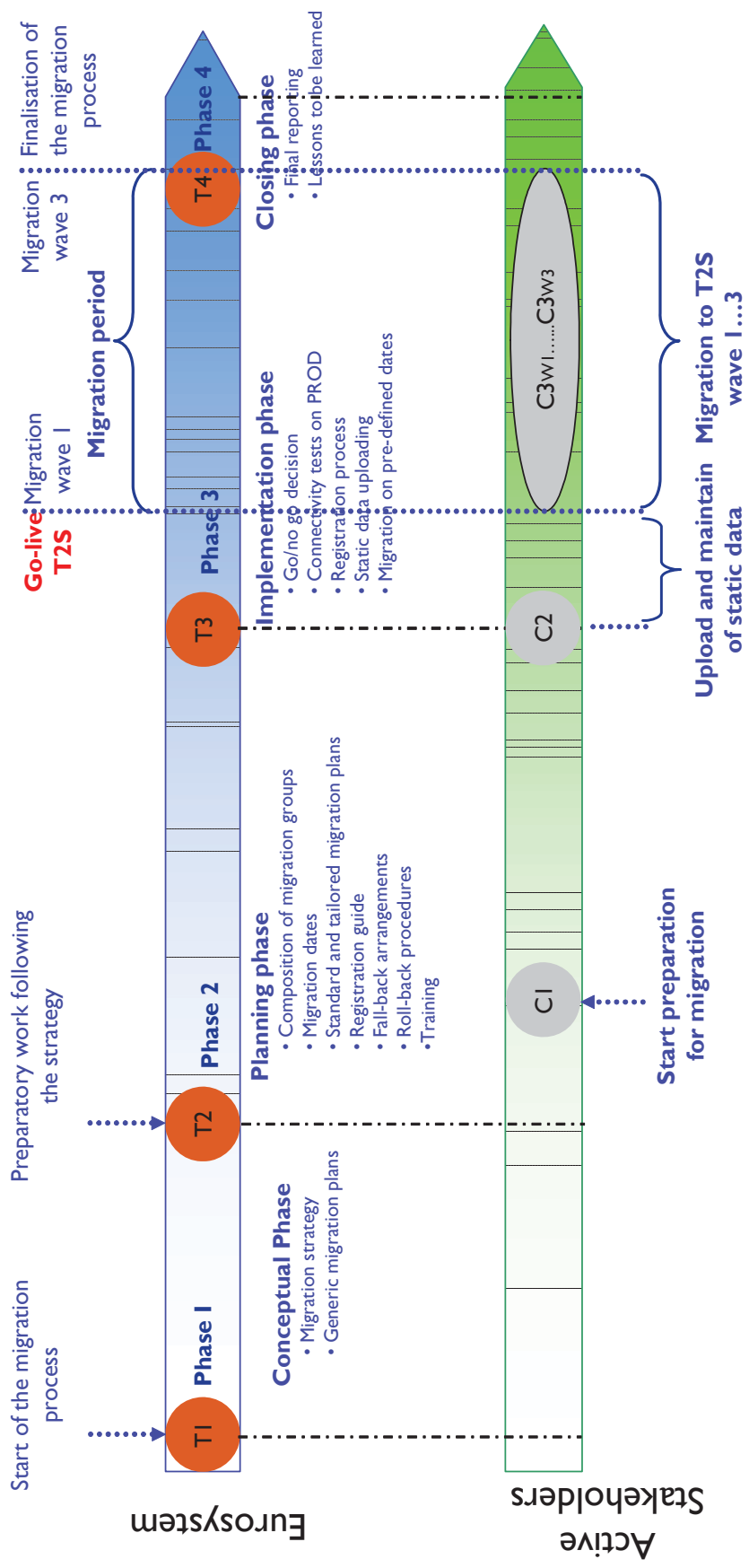

# **CURRENCY PARTICIPATION AGREEMENT**

## **SCHEDULE 5**

### **T2S SERVICE DESCRIPTION**

**Table of contents**

<b>1.</b>	<b>T2S SERVICE DESCRIPTION OVERVIEW .....</b>	<b>1</b>
1.1.	PURPOSE OF THIS NOTE.....	1
1.2.	SCOPE OF THE T2S SERVICE DESCRIPTION .....	1
1.2.1.	WITHIN THE SCOPE OF THE T2S SERVICE DESCRIPTION .....	1
1.2.2.	OUTSIDE OF THE SCOPE OF THE T2S SERVICE DESCRIPTION .....	2
1.3.	T2S SERVICE DESCRIPTION AND ITS RELATIONSHIP TO OTHER DOCUMENTS .....	2
<b>2.</b>	<b>SERVICE DELIVERY FRAMEWORK.....</b>	<b>3</b>
2.1.	SCOPE OF T2S INSTRUMENT .....	3
2.2.	SCOPE OF T2S INSTRUCTION AND TRANSACTION TYPE .....	3
<b>3.</b>	<b>T2S SD: OVERVIEW T2S SERVICES .....</b>	<b>5</b>
<b>4.</b>	<b>T2S SD.SETT: SETTLEMENT SERVICES SERVICE CLASS.....</b>	<b>7</b>
4.1.	T2S SD.SETT 010: BUSINESS VALIDATION SERVICE .....	7
4.2.	T2S SD.SETT 020: MATCHING SERVICE.....	9
4.3.	T2S SD.SETT 030: ALLEGEMENT SERVICE.....	10
4.3.1.	T2S DD.SETT 031: SETTLEMENT ALLEGEMENT SERVICE COMPONENT.....	10
4.3.2.	T2S SD.SETT 032: CANCELLATION ALLEGEMENT SERVICE COMPONENT .....	11
4.4.	T2S SD.SETT 040: SETTLEMENT SEQUENCING SERVICE .....	11
4.5.	T2S SD.SETT 050: SETTLEMENT POSTING SERVICE .....	12
4.5.1.	T2S SD.SETT 051: SETTLEMENT ELIGIBILITY CHECK SERVICE COMPONENT.....	12
4.5.2.	T2S SD.SETT 052: PROVISIONING SERVICE COMPONENT.....	12
4.5.3.	T2S SD.SETT 053: BOOKING SERVICE COMPONENT .....	14
4.6.	T2S SD.SETT 060: OPTIMISATION SERVICE .....	14
4.6.1.	T2S SD.SETT 061: TECHNICAL NETTING AND OPTIMISATION ALGORITHMS SERVICE COMPONENT .....	15
4.6.2.	T2S SD.SETT 062: PRIORITISATION SERVICE COMPONENT .....	15
4.6.3.	T2S SD.SETT 063: PARTIAL SETTLEMENT SERVICE COMPONENT .....	16
4.6.4.	T2S SD.SETT 064: AUTO-COLLATERALISATION SERVICE COMPONENT .....	17
4.7.	T2S SD.SETT 070: REALIGNMENT SERVICE.....	20
4.8.	T2S SD.SETT 080: INSTRUCTION RECYCLING SERVICE .....	21
4.9.	T2S SD.SETT 090: INSTRUCTION AMENDMENT SERVICE.....	21
4.10.	T2S SD.SETT 100: INSTRUCTION CANCELLATION SERVICE.....	22
4.11.	T2S SD.SETT 110: HOLD/RELEASE SERVICE .....	23



**Schedule 5 – T2S Service Description**

---

4.12.	T2S SD.SETT 120: EARMARKING, BLOCKING AND RESERVATION SERVICE.....	24
4.12.1.	T2S SD.SETT 121: EARMARKING SERVICE COMPONENT.....	24
4.12.2.	T2S SD.SETT 122: BLOCKING SERVICE COMPONENT.....	24
4.12.3.	T2S SD.SETT 123: RESERVATION SERVICE COMPONENT.....	24
4.12.4.	T2S SD.SETT 123: COMMON FEATURES OF THE EARMARKING, BLOCKING AND RESERVATION SERVICE COMPONENT .....	25
4.13.	T2S SD.SETT 140: CONDITIONAL SECURITY DELIVERY (CoSD) SERVICE.....	25
4.14.	T2S SD.SETT 150: LINKED INSTRUCTIONS SERVICE .....	27
4.15.	T2S SD.SETT 160: CORPORATE ACTIONS SERVICE .....	28
<b>5.</b>	<b>T2S SD.LIM: LIQUIDITY MANAGEMENT SERVICE CLASS.....</b>	<b>32</b>
5.1.	T2S SD.LIM 010: LIQUIDITY TRANSFER SERVICE.....	32
5.2.	T2S SD.LIM 020: LIMIT MANAGEMENT SERVICE.....	34
5.3.	T2S SD.LIM 030: END OF DAY (EOD) CASH MANAGEMENT SERVICE.....	36
5.4.	T2S SD.LIM 040: CORPORATE ACTION CASH SERVICE .....	37
5.5.	T2S SD.LIM 050: CASH BLOCKING AND RESERVATION SERVICE.....	37
5.6.	T2S SD.LIM 060: LIQUIDITY MONITORING SERVICE.....	38
5.7.	T2S SD.LIM 070: MULTIPLE LIQUIDITY PROVIDER SERVICE.....	39
<b>6.</b>	<b>T2S SD-STD: COMMON STATIC DATA MANAGEMENT SERVICE CLASS.....</b>	<b>41</b>
6.1.	T2S SD.STD 010: COMMON STATIC DATA MANAGEMENT SERVICE.....	41
6.1.1.	T2S SD.STD 011: INSERT SERVICE COMPONENT .....	42
6.1.2.	T2S SD.STD 012: UPDATE SERVICE COMPONENT .....	42
6.1.3.	T2S SD.STD 013: DELETE SERVICE COMPONENT .....	42
6.1.4.	T2S SD.STD 014: REACTIVATE SERVICE COMPONENT .....	43
6.2.	T2S SD.STD 020: SECURITIES REFERENCE DATA SERVICE .....	43
6.3.	T2S SD.STD 030: T2S PARTY DATA SERVICE.....	43
6.4.	T2S SD.STD 040: SECURITY ACCOUNT DATA SERVICE .....	45
6.5.	T2S SD.STD 050: CASH ACCOUNT DATA SERVICE.....	46
6.6.	T2S SD.STD 060: T2S USER DATA SERVICE.....	47
6.7.	T2S SD.STD 070: ROLES AND PRIVILEGES DATA SERVICE.....	47
6.8.	T2S SD.STD 080: RESTRICTION MANAGEMENT SERVICE.....	49
6.9.	T2S SD.STD 090: ATTRIBUTE DOMAIN DATA SERVICE (MARKET-SPECIFIC ATTRIBUTES).....	50
<b>7.</b>	<b>T2S SD. INF: INFORMATION MANAGEMENT SERVICE CLASS.....</b>	<b>51</b>
7.1.	T2S SD.INF 010: STATUS MANAGEMENT SERVICES.....	51
7.2.	T2S SD.INF 020: REPORT GENERATION SERVICE.....	51
7.3.	T2S SD.INF 030: QUERY SERVICE .....	53
7.3.1.	T2S SD.INF 031: QUERY SERVICE FOR T2S ACTOR SERVICE COMPONENT.....	54
7.3.2.	T2S SD.INF 032: QUERY SERVICE FOR CSDS SERVICE COMPONENT .....	54

Schedule 5 – T2S Service Description

---

7.3.3.	T2S SD.INF 033: QUERY SERVICE FOR CENTRAL BANKS SERVICE COMPONENT .....	54
7.3.4.	T2S SD.INF 034: QUERY SERVICE FOR PAYMENT BANKS (LIQUIDITY PROVIDERS) SERVICE COMPONENT .....	55
7.3.5.	T2S SD.INF 035: SETTLEMENT-RELATED QUERIES SERVICE COMPONENT .....	55
7.3.6.	T2S SD.INF 036: CASH BALANCE-RELATED QUERIES SERVICE COMPONENT .....	55
7.3.7.	T2S SD.INF 037: COMMON STATIC DATA-RELATED QUERIES SERVICE COMPONENT .....	56
<b>8.</b>	<b>T2S SD. CON: CONNECTIVITY / COMMUNICATION SERVICE CLASS .....</b>	<b>58</b>
8.1.	T2S SD.CON 010: MESSAGING SERVICES.....	58
8.1.1.	T2S SD.CON 011: PUSH MESSAGING SERVICE COMPONENT .....	59
8.1.2.	T2S SD.CON 012: PULL MESSAGING SERVICE COMPONENT .....	60
8.2.	T2S SD.CON 020: TECHNICAL VALIDATION SERVICES.....	60
8.3.	T2S SD.CON 030: CONNECTIVITY TYPES SERVICES .....	61
8.3.1.	T2S SD.CON 031: APPLICATION TO APPLICATION (A2A) SERVICE COMPONENT .....	61
8.3.2.	T2S SD.CON 032: USER TO APPLICATION (U2A) SERVICE COMPONENT.....	61
8.4.	T2S SD.CON 040: INFORMATION SECURITY MANAGEMENT SERVICES .....	61
8.4.1.	T2S SD.CON 041: AUTHENTICATION SERVICE COMPONENT .....	61
8.4.2.	T2S SD.CON 042: AUTHORISATION SERVICE COMPONENT .....	62
8.4.3.	T2S SD.CON 043: 4-EYES PRINCIPLE SERVICE COMPONENT.....	62
8.5.	T2S SD.CON 050: MESSAGE SEQUENCING SERVICES .....	63
8.6.	T2S SD.CON 060: DIRECT CONNECTIVITY SERVICES .....	63
8.7.	T2S SD.CON 070: ROUTING SERVICES .....	63
<b>9.</b>	<b>T2S SD. SUP: OPERATIONS AND SUPPORT SERVICE CLASS .....</b>	<b>65</b>
9.1.	T2S SD.SUP 010: BUSINESS APPLICATION CONFIGURATION SERVICES.....	65
9.1.1.	T2S SD.SUP 011: T2S CALENDAR SERVICE COMPONENT.....	65
9.1.2.	T2S SD.SUP 012: T2S SETTLEMENT DAY SERVICE COMPONENT .....	66
9.2.	T2S SD.SUP 020: OPERATIONAL MONITORING SERVICES .....	67
9.3.	T2S SD.SUP 030: BUSINESS CONTINUITY MANAGEMENT SERVICES .....	68
9.4.	T2S SD.SUP 040: DISASTER RECOVERY AND CRISIS MANAGEMENT SERVICES .....	68
9.5.	T2S SD.SUP 050: ARCHIVING SERVICES .....	69
9.6.	T2S SD.SUP 060: T2S SERVICE DESK SERVICES .....	69
9.7.	T2S SD.SUP 070: SERVICE LEVEL MANAGEMENT SERVICES .....	70
9.8.	T2S SD.SUP 080: INVOICING SERVICES.....	70
9.8.1.	T2S SD.SUP 081: T2S INVOICING TO CSDs AND CENTRAL BANKS SERVICE COMPONENT.....	71
9.8.2.	T2S SD.SUP 082: CSDs / CENTRAL BANKS INVOICING SUPPORT SERVICE COMPONENT .....	71
9.9.	T2S SD.SUP 090: CHANGE AND RELEASE MANAGEMENT SERVICES.....	72
9.9.1.	T2S SD.SUP 091: CHANGE MANAGEMENT SERVICE COMPONENT.....	72
9.9.2.	T2S SD.SUP 092: RELEASE MANAGEMENT SERVICE COMPONENT.....	74

## Schedule 5 – T2S Service Description

---

9.10.	T2S SD.SUP 100: TEST AND TRAINING SERVICES .....	75
9.10.1.	T2S SD.SUP 101: TESTING SERVICE COMPONENT .....	75
9.10.2.	T2S SD.SUP 102: TRAINING SERVICE COMPONENT .....	75

## **1. T2S Service Description overview**

### **1.1. Purpose of this note**

This note provides a common base for the description of T2S Services, especially pertaining to the Framework Agreement and to the Currency Participation Agreement.

This T2S Service Description for the Operational Phase of T2S focuses on:

- (1) providing a common structure for the services that T2S will deliver, i.e. settlement services, liquidity management, Common Static Data services, information services, connectivity services, operational and support services as well as the individual services;
- (2) the content of the service from the T2S Users' perspective, i.e. what services the T2S Users will receive, and the business perspective of the interchanges between T2S and the T2S Users;
- (3) the boundaries of the services T2S will deliver to its users, i.e. what is within the scope of T2S Services, and what is outside of the scope of T2S Services.

Some of the T2S services listed in this Schedule 5 are delivered by means of Common Components.

### **1.2. Scope of the T2S Service Description**

#### **1.2.1. Within the scope of the T2S Service Description**

T2S is a technical solution to support Central Securities Depositories (CSDs) by providing core, borderless and neutral settlement services. The objective is to achieve harmonised and commoditised settlement in Central Bank Money (CeBM) in euro and other eligible currencies for substantially all securities in Europe.

The Eurosystem manages and operates the business application and the technical solution providing the T2S Services, this service provision by the Eurosystem is hereafter referred to simply as "T2S". The Contracting CSD will maintain full control over the business and contractual relationship with its customers.

The T2S Service Description describes all services T2S will deliver for the T2S Operational Phase including all services delivered to all Participating CSDs, to all Directly Connected Parties (DCPs), and to all participating Central Banks (CBs, comprised of all euro area NCB and all non-euro area NCB participating in T2S), once T2S is in full operation. The T2S Service Description itself is subject to the rules and procedures established for all Schedules and Annexes of the Framework Agreement and Currency Participation Agreement.

**Schedule 5 – T2S Service Description**

---

**1.2.2. Outside of the scope of the T2S Service Description**

This Service Description describes only the services T2S will deliver during the Operational Phase. The services delivered by the T2S Programme during the Development Phase and the Migration Period are not described in this note<sup>1</sup>.

The Service Description furthermore provides background and relevant information with regard to:

- a. The Service Level Agreement (SLA<sup>2</sup>), which will contain all Key Performance Indicators (KPIs), the latter will not be defined nor referenced in the Service Description.
- b. The T2S technical architecture is not described in this Service Description and nor are the technical details required to establish the connectivity to T2S.

**1.3. T2S Service Description and its relationship to other documents**

The Service Description is a high level description of the Services T2S delivers during the Operational Phase thereby identifying the scope of the T2S Services and as such complementing the T2S Scope Defining Set of Documents.

Since, the Service Description is a high level description, in some parts of the Service Description it has been indicated in which documents, e.g. Business Process Description, User Handbook, Manual of Procedures (MoP), further and more detailed information can be found.

---

<sup>1</sup> Details on the T2S Programme can be found in the Framework Agreement/Currency Participation Agreement and its relevant Schedules

<sup>2</sup> The SLA is a separate document linked closely to this Service Description. The Service Description describes the services T2S clients receive, the SLA defines the relevant KPIs, as well as their control and reporting procedures. Therefore, these two documentations are closely linked and harmonised

## **2. Service delivery framework**

### **2.1. Scope of T2S instrument**

In principle, T2S covers all securities that comply with the following eligibility criteria, i.e. that:

1. have an ISIN code, as instrument identifier;
2. can be settled via a CSD in T2S;
3. can be settled in book-entry form; and
4. are fungible (from a settlement process perspective).

Securities that do not fall within the scope of any connected CSD are not part of T2S either.

T2S can settle only securities that are compliant with the above criteria 1 to 3, certain securities, compliant with the first three criteria, but not compliant with criteria 4 (non-fungible from a settlement perspective), may still be entered in and processed by T2S.

T2S settles all eligible securities in a standardised settlement process.

### **2.2. Scope of T2S instruction and transaction type**

The instruction types covered by T2S are the following:

- Settlement Instruction
- Liquidity Transfer
- Settlement Restriction
- Amendment Instruction
- Cancellation Instruction
- Hold / Release Instruction

T2S settles only settlement transactions with a CeBM cash leg (or no cash leg), it will not provide settlement in Commercial Bank Money (CoBM). T2S provides services for securities settlement and the related cash settlement using a number of transaction types:

- FOP (Free of Payment) consists of DFP (deliver free of payment) and RFP (receive free of payment). In both cases, securities are delivered / received without payment being made.
- DVP (Delivery versus Payment) and RVP (receive versus payment) define an exchange of securities for cash. DvP and RvP are both securities settlement mechanisms which link

## Schedule 5 – T2S Service Description

---

a securities transfer and a funds transfer in such a way as to ensure that delivery occurs if - and only if - the corresponding payment occurs.

- DWP (Deliver with Payment) and RWP (Receive with Payment) is a type of instruction and settlement mechanism, specifying the delivery of securities together with a cash payment. For example, trade netting by a Central Counterparty (CCP), as an authorised CSD participant, may result in such instructions.
- PFOD (Payment Free of Delivery) defines an exchange of cash without the delivery of securities.

### **3. T2S SD: Overview T2S Services**

T2S deploys a flexible hierarchical party model to allow CSDs and Central Banks to manage their accounts and parties in an efficient way. Roles, including some of the key responsibilities, are allocated in line with the differentiation into

- a securities' perspective (CSDs), and
- a cash's perspective (Central Banks)

The structure of this Service Description document is based on the above mentioned differentiation between the securities perspective (CSDs) and the liquidity management perspective (Central Banks)<sup>3</sup>:

- CSDs are the gateways through which various market parties can access T2S. Depending on their needs, a CSD's participants may continue to contract with one or more CSDs for the settlement of their trades and collateral operations (and those of their customers) in T2S. Each CSD will set up and maintain its own Security Accounts' structure in T2S. Each CSD is responsible for setting up and maintaining all CSD Static Data relating to the settlement activities of its participants. A T2S Actor settling through more than one CSD in T2S can have Security Account(s) with each of the CSDs it uses for settlement.
- All Central Banks whose currencies are available for settlement in T2S have the responsibility to set up and to maintain Dedicated Cash Accounts (DCAs) in T2S if they have concluded a relevant agreement with eligible entities. Furthermore, these Central Banks are also responsible for setting up and maintaining all Central Bank Static Data relating to the DCAs of its members. Cash settlements in T2S take place exclusively on T2S DCAs. Only a CeBM account opened on the books of a Central Bank whose currency is available for settlement in T2S may serve as a T2S DCA.

The totality of the T2S Services (level 1 of the service hierarchy description) are broken down into service classes (level 2 of the service hierarchy) and services (level 3). If the latter (level 3) contain functionally diverse components, level 4 of the service hierarchy describes these service components:

---

<sup>3</sup> A more detailed description of the account structures deployed by T2S can be found in the User Detailed Functional Specifications (UDFS), chapter 1.2.6. Accounts structure and organisation



Schedule 5 – T2S Service Description

---

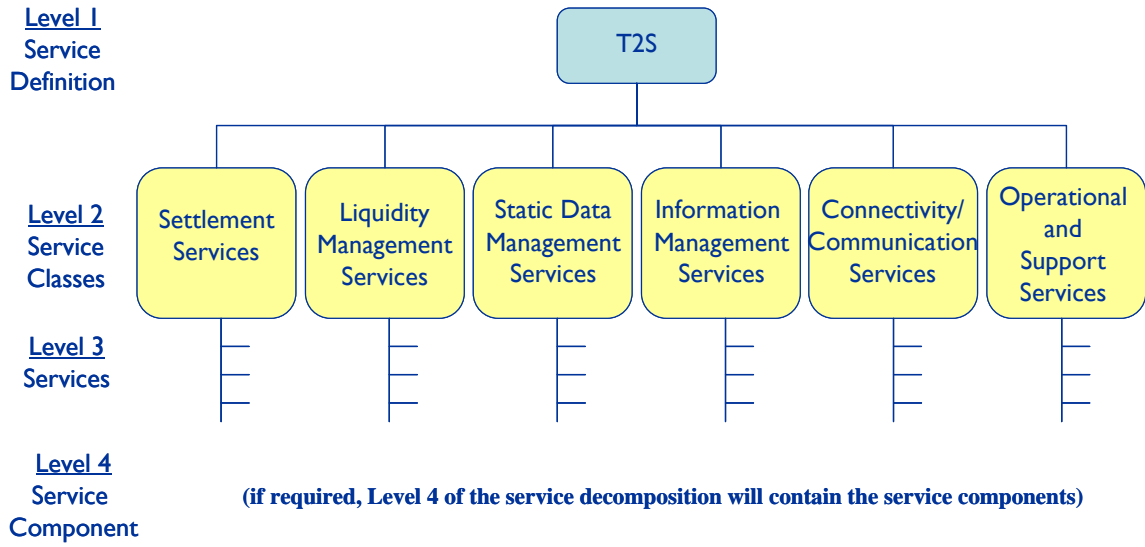

**4. T2S SD.SETT: Settlement services service class**

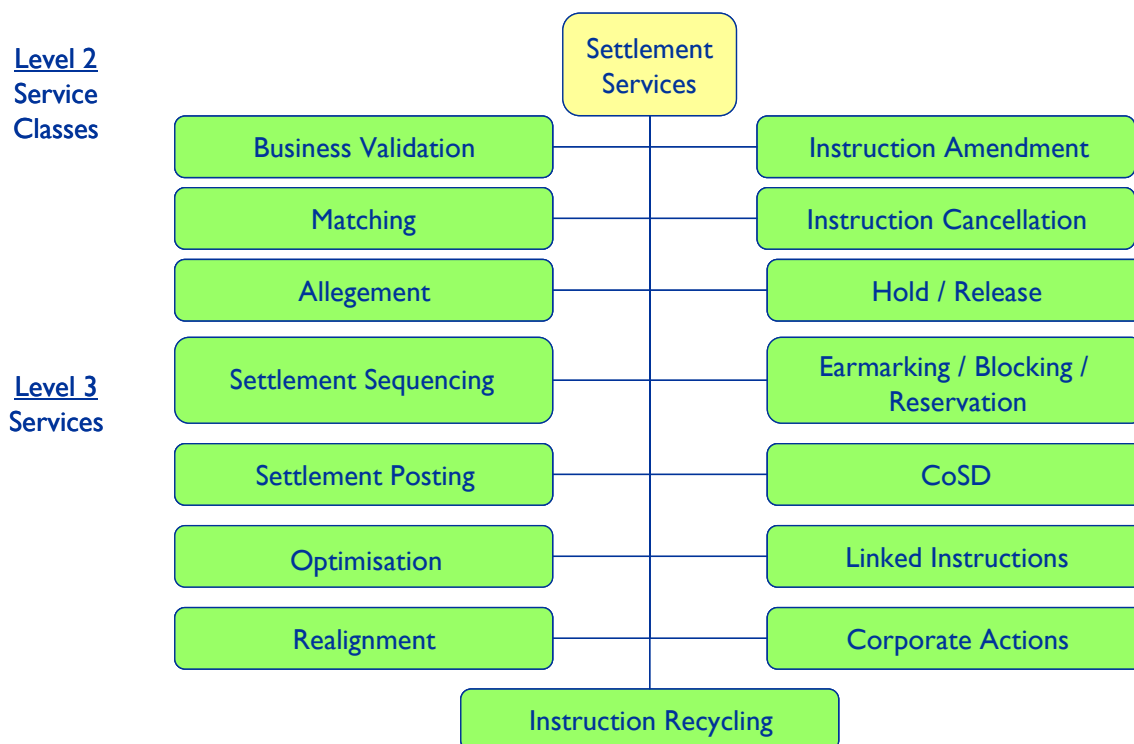

**4.1. T2S SD.SETT 010: Business validation service**

Each instruction will go through the same T2S standard validations.

With the exception of the additional information fields as described below, the business validation service ensures that the content of the received message is valid, i.e. contains all required fields and complies with the rules defined for the content of these fields. These consistency checks ensure that the message can be processed by T2S as intended and is consistent with the relevant rules for this message stored in Common Static Data.

Business validation in T2S consists of two different types of validations:

1. Contextual checks, that is when the validation of one field is dependent on the content of another field, e.g. reference / Common Static Data or other data provided via the Graphical User Interface (GUI);
2. Event-driven checks, e.g. settlement date change.

All incoming messages are validated when they enter T2S and re-validated (as are all pending instructions) at the start of a new Settlement Day. Updates of the Common Static Data used for business validation purposes result in revalidation of all relevant instructions. T2S assigns a status of matched/unmatched at the same time that the instruction is validated.

Messages sent by a T2S Actor to T2S may contain Additional Information Fields which T2S

**Schedule 5 – T2S Service Description**

---

Actors may use for their own purposes. This additional information is neither required for nor related to any T2S process and is therefore neither validated nor further processed within T2S. T2S stores this additional information together with the information it has processed.

Once T2S has successfully validated the compliance of the data - contained in the instruction with the data stored in Common Static Data relevant for the business validation process - the instruction is routed to the relevant processing module of T2S. If settlement-related process indicators are specified by the instructing T2S Actor, T2S checks that they are valid for the type of instruction and the instructing T2S Actor in question. The settlement-related process indicators are used to perform certain actions in the settlement process relating to an instruction. T2S Actors may use the non-settlement-related link indicator “INFO” to link instructions for information purposes.

In the event of instructions being held/released, cancelled, amended or that make use of a previous settlement restriction, T2S verifies that the previous or related reference exists. T2S performs the business validation on the maintenance/new instruction to ascertain that it is valid and consistent with the previous or related instruction. After identifying a validation error, T2S continues to validate as far as possible (taking into account potential interdependencies between the validated data). If validation errors are found, T2S reports all of them in a single message to the T2S Actor and rejects the instruction.

After successful validation, T2S stores the instruction, assigns the corresponding statuses and informs the instructing T2S Actor and its CSD of the validation result, depending on their message subscription preferences. Once validated:

- settlement instructions that require matching are forwarded for matching,
- maintenance instructions are forwarded to the maintenance functionality,
- settlement restrictions are forwarded for settlement only on their Intended Settlement Date (ISD),

while all other instructions are forwarded directly to the settlement functionality.

T2S must support the CSDs and Central Banks by offering the capability to provide specific validations and processing of messages to fulfil legal, regulatory and supervisory requirements in the markets that they service. T2S therefore allows the CSDs and Central Banks to define their own restriction types.

T2S triggers a revalidation of all relevant recycled instructions when settlement-related Common Static Data change. T2S cancels instructions that do not pass the revalidation successfully and informs both the CSD and the instructing T2S Actor of the cancellation.

T2S validates all incoming and recycled instructions against rules and parameters defined in the Common Static Data for the configuration of restriction types. T2S thus checks and validates whether there are any applicable restrictions. If there are, and depending on the type of the

**Schedule 5 – T2S Service Description**

---

restriction, T2S either accepts, rejects or puts the instruction on hold until it is released for further processing.

**4.2. T2S SD.SETT 020: Matching service**

The settlement instruction Matching service in T2S compares the settlement details provided by the buyer of securities with those provided by the seller of the securities in order to ensure that both parties agree on the settlement-related terms of an instruction.

T2S provides real-time matching, compliant with the rules of the European Securities Services Forum (ESSF)/European Central Depositories Association (ECSDA), throughout the operating day (except during the Maintenance Windows). Matching in T2S is mandatory for cross-CSD settlements. Matching for intra-CSD settlements may take place in T2S or in the legacy systems of the CSD.

T2S only attempts to match validated settlement instructions that entered T2S as “unmatched”. If matching is successful, T2S assigns the match status “matched” to the settlement instructions and informs the T2S Actor of the matching of their settlement instruction. If T2S finds no corresponding unmatched counterpart instruction for the unmatched settlement instruction, the match status remains unchanged and T2S sends no information to the instructing T2S Actor.

T2S waits for the missing counterpart instruction for a predetermined period before generating an allegation message for the counterpart in the unmatched instruction. T2S sends the allegation message to the relevant counterparty only if the counterpart has subscribed to receive allegation messages.

T2S attempts to match the instruction for 20 working days (T2S calendar) after the Intended Settlement Date or the date of the last status change, in accordance with the ESSF/ECSDA recommendation. After 20 working days, T2S cancels the underlying instruction and informs the relevant T2S Parties.

T2S matches the settlement cash amount for T2S eligible settlement currencies with a certain tolerance level (i.e. in the event that there is no perfect match). The tolerance amount has two different bands per currency, depending on the counter value, in line with ECSDA rules. The general tolerance amount proposed by ECSDA for matching the settlement amount field in euro is currently €25 when the counter value is above €100,000 or €2 when it is €100,000 or less. Once T2S has matched two instructions with a difference in the settlement amount that is less than the tolerance amount, T2S shall settle the instruction with the seller’s settlement amount.

T2S matches different types of fields:

1. Mandatory matching fields

Mandatory matching fields are those fields that must exist in the instruction and which values should be the same in both Settlement Instructions, except for (i) the Settlement

**Schedule 5 – T2S Service Description**

---

Amount of DVP/PFOD instructions for which a tolerance might be applied; and (ii) the Credit/Debit Code (CRDT/DBIT); and (iii) the Securities Movement Type Deliver/Receiver (DELI/RECE), whose values match opposite (meaning that opposite values in instructions are considered as required to match the instructions)

**2. Non-mandatory matching fields**

T2S supports two types of non-mandatory matching fields:

- a. Additional matching fields are fields that are initially not mandatory but become mandatory matching fields when either one of the counterparts to the settlement provides a value for them in its instruction. T2S cannot match a filled-in additional matching field with a field with no value (null / zero value).
- b. Optional matching fields are fields that are initially not mandatory:
  - i. If only one T2S Party provides content in an optional matching field, T2S may match with a field with no value (null / zero value).
  - ii. If both settlement counterparts provide a value for the same field in their instructions, then the optional matching field becomes mandatory for matching

**4.3. T2S SD.SETT 030: Allegement service**

T2S uses allegement messages to inform counterparties that an instruction is missing. An allegement message advises an account owner that another T2S Actor has issued instructions against its account for which the account owner has no corresponding instruction in the Securities Settlement System. Allegements will be sent only if the counterparty has subscribed to receive such messages. T2S alleges a T2S Actor when a settlement instruction or a cancellation instruction is missing. Allegement messages may be used for any unmatched instruction that requires matching.

**4.3.1. T2S DD.SETT 031: Settlement allegement service component**

After the first unsuccessful matching attempt, T2S waits for the missing counterparty instruction for a predetermined period of time before generating an allegement message. If the instruction is still unmatched at the end of this period, an allegement message is generated. T2S sends an allegement message for the unmatched instruction only if the counterparty has subscribed to receive allegement messages.

T2S supports two standard delay periods for sending allegements to the counterparties of the unmatched instruction.

- “Allegement from first unsuccessful matching attempt”, as the standard delay period from the first unsuccessful attempt to match a settlement instruction

**Schedule 5 – T2S Service Description**

---

- “Allegement before Intended Settlement Date”, as the standard delay period measured backwards from the FOP cut-off time on the Intended Settlement Date.

T2S sends out the allegement at the earliest point in time between the two standard delay periods. T2S calculates the standard delay period in hours and minutes.

If the previous allegement message is no longer valid, T2S sends an allegement removal or an allegement cancellation. An allegement cancellation means the cancellation of an allegement message sent previously, due to a cancellation of the settlement instruction by the sender. An allegement removal acknowledges that an allegement message sent previously is no longer valid, because T2S has in the meantime received the missing instruction from the alleged T2S Party.

**4.3.2. T2S SD.SETT 032: Cancellation allegement service component**

T2S also provides allegement services in the event of a missing counterpart cancellation instruction, via a status advice message. T2S sends out the cancellation allegement without waiting for any predetermined period to have elapsed. The cancellation instruction remains pending until it matches with a valid counterpart cancellation instruction.

If the cancellation allegement sent via status advice is no longer valid because the revalidation of the settlement instruction has been unsuccessful, the counterparty has responded with a cancellation instruction, or the underlying matched settlement instructions have been settled, T2S sends only the settlement confirmation (in case of settled underlying instructions) and status advices (in case of cancelled underlying instructions) to both parties.

T2S does not send a status advice to the counterparty to communicate cancellation of the previous cancellation allegement.

**4.4. T2S SD.SETT 040: Settlement sequencing service**

Sequencing is the pre-determined order defined in T2S in which instructions are submitted for settlement.

During the Real Time settlement, instructions are processed in the order in which they arrive for settlement.

For night-time settlement, sequencing refers to the order in which the settlement of certain sets of instructions is attempted in T2S. Settlement instructions are processed in a particular sequence, (i.e. in a fixed order) to avoid the use of security positions and/or cash resources for any transaction other than those submitted in the sequence concerned. T2S runs two settlement cycles with predefined settlement sequences during the night. In each settlement sequence, T2S will perform a settlement attempt for those settlement transactions selected based on the eligibility criteria of the sequence including:

**Schedule 5 – T2S Service Description**

---

- all new instructions with the current ISD entered into T2S until the launch of the current settlement sequence. These instructions include, for instance, settlement instructions providing liquidity via lending (securities lending) that are intended to settling instructions that could not be settled in an earlier settlement attempt;
- all recycled instructions that could not be settled in an earlier settlement attempt. Such recycled instructions include all instructions that could not be settled in the previous settlement attempts.

**4.5. T2S SD.SETT 050: Settlement posting service**

The transactions are settled in T2S by booking the cash and securities debits and credits in accordance with the relevant instructions on the relevant T2S DCAs and Security Accounts (either accounts identified in the instructions being settled or accounts predetermined by default).

The settlement posting service consists of three service components:

- Settlement eligibility check
- Provisioning
- Booking

**4.5.1. T2S SD.SETT 051: Settlement eligibility check service component**

The settlement eligibility check is the final validation before settlement, as it is necessary to identify the appropriate instructions for the final settlement process. The eligibility check considers

- the Intended Settlement Date (ISD),
- the potential blocking of the T2S Actor, Security Account, security or T2S DCA from settlement and
- whether or not the instruction is on hold,
- whether the instruction is linked to other instructions,

before an instruction is submitted to the provisioning and booking process. T2S forwards for settlement only those instructions that meet the eligibility criteria for settlement. Settlement instructions which do not meet the eligibility criteria remain unsettled.

**4.5.2. T2S SD.SETT 052: Provisioning service component**

The provisioning or provision-check ensures that the eligible transaction can be forwarded for booking (and thereby finally settled) if, and only if, the booking does not cause the account balances of the relevant securities and the T2S DCA to become negative, with the exception of

**Schedule 5 – T2S Service Description**

---

T2S Central Banks own accounts, T2S transit accounts and Issuer CSD balance accounts, which may have negative balances.

The provision-check covers both settlement legs of the relevant transaction (e.g. the cash and securities legs for a DvP transaction). T2S does not consider reserved/blocked securities quantities or cash amounts on the relevant accounts as available for the provision-check, unless the instruction being settled refers to the initial reservation/blocking instruction.

When an individual external guarantee limit, unsecured credit limit or auto-collateralisation limit is defined by the relevant Central Bank (or by the relevant Payment Bank for the settlement of the instructions of the T2S parties for which it provides cash settlement services), T2S ensures that the net cash debit resulting from the booking of any instruction(s) of the relevant T2S parties does not exceed the unused part of this external guarantee limit, unsecured credit limit or auto-collateralisation limit.

T2S performs the provision check in the following sequence:

1. Provision check of available securities position on the Security Account (only for the settlement of securities)
2. Provision check for the T2S DCA and auto-collateralisation (if required)
3. Provision check on the external guarantee limit
4. If auto-collateralised: provision check on the auto-collateralisation limit of the client of the Payment Bank
5. Provision check on the unsecured credit limit

When several instructions are submitted together in a settlement attempt, the provision-check considers the final net balance resulting from the booking of all the relevant instructions (and not from each and every instruction). In other words, in its provision-check T2S takes into account the technical netting effect.

If the provision-check on the net balance is not satisfactory, T2S identifies the instruction(s) responsible for the provision-check's failure.

These instructions are either:

- submitted for an auto-collateralisation process if the fail originates from a lack of cash; or,
- submitted for partial settlement (only as a last resort, i.e. if auto-collateralisation is not possible or not sufficient and only if the instructions are eligible and are within the partial settlement window) if the fail originates from a lack of securities or from a required substitution of collateral.



**Schedule 5 – T2S Service Description**

---

**4.5.3. T2S SD.SETT 053: Booking service component**

Final booking is only posted if the provision-check on the accounts (securities and T2S DCAs) referred to in the settlement instructions (or on the accounts predetermined by default) is satisfactory.

Once booked by T2S on the T2S parties' Security Accounts and T2S DCAs, cash and securities debits and credits are final, i.e. irrevocable and unconditional. The booking must not be conditional on any external event (e.g. such as another booking in the payment or settlement system/arrangement of an external Central Bank registrar, commercial bank or CSD), this means that any such condition must have been resolved before the booking in T2S is undertaken.

Because bookings are final, T2S will not automatically unwind credit or debit even if it was done incorrectly.

Each and every transaction is booked on a gross basis. This is without prejudice to the use of the technical netting effects in the provision check when several instructions are submitted together for settlement (either for optimisation purposes or because they are linked by a T2S Actor).

**4.6. T2S SD.SETT 060: Optimisation service**

T2S optimisation services is intended to determine the optimum balance between maximising the volume and the value of the settlement with the available securities, in order to minimise the number and value of unsettled instructions at the end of the night-time settlement process as well as to minimise the number and value of fails at the end of the Settlement Day.

Optimisation procedures are specific processes aimed at increasing settlement efficiency. Such processes detect and resolve settlement gridlocks, and perform technical netting of obligations in cash and securities, with a view to settle new instructions as well as instructions that could not be settled when previously attempted. Optimisation procedures are available both during the night-time settlement window and during the Real Time Settlement. When several unsettled instructions are optimised together and a chain of instructions is submitted for settlement, T2S includes the securities and cash received during the process of settling the relevant chain of instructions in the optimisation process.

During the night-time settlement window, the T2S optimisation procedure covers all instructions submitted for settlement (either new instructions or recycled instructions that could not be settled when previously attempted).

During the Real Time Settlement, T2S optimisation procedure runs in parallel to real-time settlement processes and covers instructions that could not be settled when previously attempted.

When necessary, T2S combines the four optimisation procedures described below (technical netting/ optimisation algorithms, prioritisation, partial settlement and auto-collateralisation).

**Schedule 5 – T2S Service Description**

---

**4.6.1. T2S SD.SETT 061: Technical netting and optimisation algorithms service component**

The technical netting is intended to limit the resources necessary for the settlement of a set of instructions submitted together for settlement. Without prejudice to the fact that booking takes place on a gross basis, T2S reduces, through technical netting, the final net balance to be credited and debited on Security Accounts and/or Dedicated Cash Accounts. When performing its provision-check, T2S considers the final net balance that results from the booking of all the instructions submitted together for settlement (and not that resulting from each and every individual instruction).

During the night-time settlement window, T2S submits all eligible instructions for settlement and optimises all these instructions together. During day-time, real-time settlement optimisation, optimisation algorithms identifying chains of instructions (e.g. such as empty circles, back-to-back instructions) are used to resolve gridlock situations, and to increase the volume and value of settlement and hence, to reduce the value and volume of pending instructions.

**4.6.2. T2S SD.SETT 062: Prioritisation service component**

Optimisation procedures will take into account the four different priority levels of instructions. T2S automatically assigns predetermined levels of priority for certain specific instructions identified in the Common Static Data. The four different levels of priority identified are:

1. Reserved priority: Only Participating CSDs and Central Banks can assign a “reserved priority” for specific instructions such as intraday corporate actions or certain Central Banks’ specific operations related to the provision/ reimbursement of their credit operations.
2. Top priority: T2S automatically assigns top priority to transactions of trading platforms (MTFs, stock exchanges, etc.) with and without CCP and OTC instructions with CCP. To that end, the parameters for identifying transactions (to which this top priority level must be assigned) are predetermined in Common Static Data and apply by default to all the relevant transactions. T2S does not allow top priority to be assigned to any other category of transactions (either by default or at a transaction level).
3. High priority: T2S Actors can assign high priority to their settlement instructions; or
4. Normal priority: T2S assigns normal priority to all other instructions, but enables T2S parties to assign them a high priority on an instruction-by-instruction basis.

For levels 3 and 4 only, the instructing T2S Actor may change the priority level of an instruction (only the deliverer may change normal priority to high priority or high priority to normal priority).

T2S optimises and recycles settlement instructions in accordance with their priority levels in such a way that if several instructions compete for use of the same securities and/or cash resources, for

**Schedule 5 – T2S Service Description**

---

settlement purposes preference is given to the instruction with the highest level of priority. In addition to the priority level, T2S also considers the ISD of the instruction so as to favour the settlement of instructions with the earliest settlement date and thus avoid instructions with low priority not being settled.

For Real Time Settlement, the prioritisation applies only to instructions to be recycled in the settlement queue (i.e. failed instructions). Any increase of a position triggers an optimisation for the International Securities Identification Number (ISIN) concerned. T2S recycles instructions if there is insufficient position.

Furthermore, during the Real Time Settlement, the priority level is taken into account by the settlement procedure only for instructions that failed to settle in a previous settlement attempt. These are subsequently submitted for recycling and optimisation procedures.

**4.6.3. T2S SD.SETT 063: Partial settlement service component**

T2S uses partial settlement for instructions that could not be settled due to the lack of securities providing the settlement instruction fulfils all criteria for partial settlement. A lack of cash does not trigger partial settlement. Instructions linked by T2S Actors are excluded from partial settlement (see UDFS for further details).

The partial settlement procedure is used for all T2S instructions, unless one of the counterparts indicates at instruction level that partial settlement is not allowed (partial indicator set to no/false), and if the following conditions are met:

- the partial settlement threshold criteria are met, set for both securities and cash, and defined as part of the Common Static Data, and
- the partial settlement window is active.

When submitting an unsettled instruction for partial settlement, T2S attempts to settle the maximum quantity of securities available on the Security Account of the seller, taking into account the threshold chosen by the counterparts.

Once partial settlement has been invoked, T2S allows a duly authorised Actor to modify only the priority of the instruction, or to hold, to release or to cancel the pending part of a partially settled instruction. When an instruction is partially settled, T2S does not automatically cancel the original instruction. T2S keeps the original instruction and updates in accordance with the partial settled volumes in the status management.

Reverse collateral instructions are not subject to partial settlement.

T2S uses its own partial settlement parameter to activate and de-activate partial settlement as part of the continuous optimisation process. T2S allows the definition of several T2S parameters for activating and deactivating the partial settlement procedure during the night-time and day-time settlement periods. The T2S partial settlement parameter defines at which moment in time or

**Schedule 5 – T2S Service Description**

---

based on which event T2S activates or de-activates a partial settlement procedure.

In order to minimise fails due to a lack of securities, T2S allows partial settlement in specific time windows, a predefined period before the end of Real Time Settlement and at the end of the last night time cycle during the night-time settlement. T2S submits to partial settlement all eligible instructions that failed to be settled in a previous attempt during the night and deactivates the partial settlement functionality at the closure of the night-time settlement period (see UDFS). T2S submits at least once all those instructions for partial settlement that it has identified as eligible for partial settlement before the partial settlement procedure is deactivated.

T2S informs the CSD and/ or the DCP when partial settlement occurs, depending on the message subscription preferences.

**4.6.4. T2S SD.SETT 064: Auto-collateralisation service component**

T2S provides auto-collateralisation functionality during the whole T2S settlement period in order to facilitate the settlement of underlying securities-related instructions that would fail to settle due to a lack of cash on a Dedicated Cash Account (DCA) and/or insufficient external guarantee headroom on a Credit Memorandum Balance (CMB)<sup>4</sup>. T2S provides the auto-collateralisation service on the basis of the list of eligible collateral, relevant prices and limits provided by the Central Banks and Payment Banks.

The auto-collateralisation functionality with Central Banks and with Payment Banks is available to eligible T2S parties as defined in Common Static Data, provided that auto-collateralisation headroom is available. T2S triggers auto-collateralisation with Central Banks in case of lack of cash on the T2S DCA of the Payment Bank to which the settlement instruction is referring. T2S triggers auto-collateralisation with a Payment Bank (client-collateralisation) in the event of insufficient external guarantee headroom on the CMB of a client of the Payment Bank, that owns the Security Account to which the settlement instruction refers.

T2S allows collateral provided for intraday credit provision in CeBM through auto-collateralisation to be pledged or transferred to a separate account (in accordance with the legal framework chosen by the relevant Central Bank). Collateral provided for auto-collateralisation with Payment Banks can only be transferred to a separate account of the Payment Bank. Intraday credit granted in CeBM through auto-collateralisation can be used only for the settlement of the underlying instructions. The credit amount provided is equal or less than the collateral value of the securities used as collateral, the collateral value being the price provided for a certain security multiplied by the number or nominal amount of the security concerned.

An intraday credit provision through auto-collateralisation is always fully collateralised in T2S

---

<sup>4</sup> Further described in the relevant chapter of the Liquidity Management Services below.

**Schedule 5 – T2S Service Description**

---

- Either with securities already held by the buyer via collateral-on-stock, or
- Through collateral-on-flow via the eligible securities that are being purchased.

These securities must be recognised as eligible collateral by Central Banks or Payment Banks and the relevant Payment Bank or its clients must earmark them for their use as collateral. Duly authorised T2S Actor may also earmark a Security Account from which securities may be used for auto-collateralisation. The security account holding the earmarked securities must be linked to the DCA opened by the Central Bank.

In order to provide intraday credit through auto-collateralisation in T2S to one or several eligible Payment Banks, each national Central Bank has to open a T2S Central Bank cash account on which all debits corresponding to its intraday credit provisions through auto-collateralisation will be posted. The T2S central bank cash account is allowed to have a negative cash balance.

The Payment Banks must open one Security Account (via their CSD) dedicated to auto-collateralisation for each of their clients. T2S uses these accounts when transferring the collateral from the client to the Payment Bank. If allowed by the respective Central Bank, the Payment Banks may use the securities positions received during the client-collateralisation procedure as collateral for auto-collateralisation procedure with the Central Banks. In such cases, the Payment Bank has the option to either earmark the Security Accounts for auto-collateralisation purpose only or earmark specific securities positions in the Security Account for auto-collateralisation. The Payment Bank will be able to use such Security Accounts for both (a) receiving collateral in case of client-collateralisation (b) and providing collateral for auto-collateralisation with Central Banks.

Each national Central Bank is required to determine in Common Static Data the collateralisation procedure for which it opts, i.e. (i) transfer to an account opened in the Central Bank's name, or (ii) transfer to an account pledged in its favour, or (iii) reservation of securities. This must be done for all eligible Payment Banks to which the relevant Central Bank provides intraday credit through auto-collateralisation.

For each of their Security Accounts, T2S parties may indicate via the T2S earmarking service whether T2S may use securities from that account when generating auto-collateralisation operations with Central Banks or Payment Banks on a specific T2S DCA. When such a link exists between a Security Account and a T2S DCA, T2S will use securities from that account in auto-collateralisation operations with either Central Bank or the Payment Bank (acting as credit provider), depending on the earmarking options.

Schedule 5 – T2S Service Description

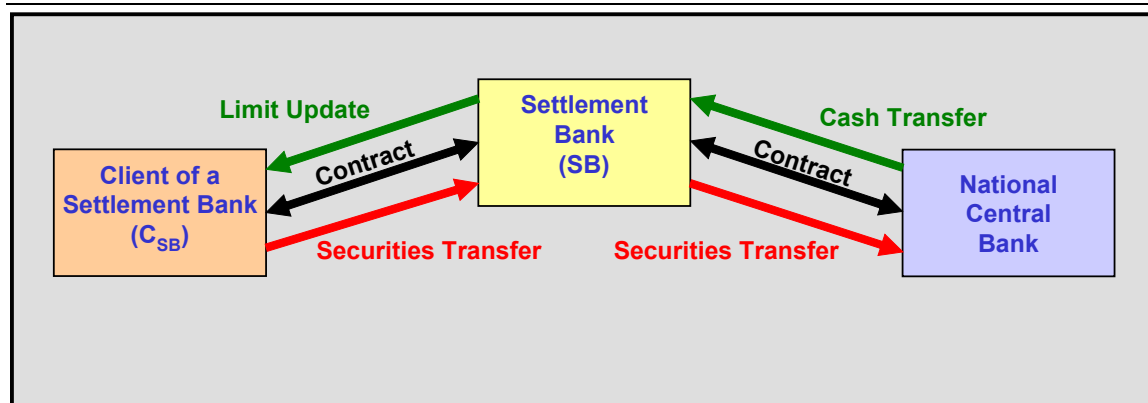

T2S generates auto-collateralisation operations only when they allow the settlement of the underlying settlement transaction(s) and when sufficient headroom exists on the auto-collateralisation limit. When triggering auto-collateralisation, T2S also considers the unsecured credit limit headroom available that could complement the auto-collateralisation operation in the event of auto-collateralisation with Payment Banks (client-collateralisation). Each Central Bank and Payment Bank is able to increase or decrease at any moment of the Settlement Day the auto-collateralisation limit of an eligible Payment Bank or client of the Payment Bank.

T2S submits auto-collateralisation instructions for settlement on an all-or-none basis together with the underlying settlement instructions in order to ensure that the amount of intraday credit provided through auto-collateralisation is automatically and exclusively used to settle the underlying instruction(s).

On the basis of the type of collateral movement chosen by each Central Bank providing credit, T2S will collateralise the intraday credit provided through auto-collateralisation either:

- by transferring the securities from the Security Account of a T2S Actor to the Security Account of the Central Bank providing the credit; or
- by transferring the securities from the account of the bank receiving the credit to another account of this Payment Bank which the NCB has linked to the Payment Bank’s DCA for auto-collateralisation in T2S (the second Security Account being pledged to the Central Bank providing the credit where the securities are in the name of the bank receiving the credit); or
- by blocking the securities on the Security Account of the Payment Bank receiving the credit; in such a case, the securities will be blocked in favour of the Central Bank providing the credit and T2S will not allow the Security Account holder to use the relevant securities as long as they are blocked.

When auto-collateralisation on flow and on stock are both possible for the settlement of a transaction or a set of transactions, T2S prefers to resorts to auto-collateralisation on flow before auto-collateralisation on stock. When the collateral value of the securities on flow is not sufficient to cover the amount of credit granted, T2S complements collateral on flow with

**Schedule 5 – T2S Service Description**

---

collateral on stock. Finally, when securities being purchased in the underlying transaction are not eligible collateral (e.g. equities for Eurosystem intraday credit) and therefore cannot be used as collateral on flow, T2S uses collateral on stock to secure the amount of intraday credit granted through auto-collateralisation.

Whenever T2S generates and settles an auto-collateralisation operation, it creates and sets on hold the reimbursement of that auto-collateralisation operation - and the exact reverse operation (i.e. same amounts, same accounts, etc). The Payment Banks are able to trigger the reimbursement of their auto-collateralisation operations with Central Banks and with their clients at any moment during the daytime real-time settlement by releasing the relevant on hold reimbursement instructions.

Auto-collateralisation provides intraday credit that must be repaid at the end of the day. T2S uses all available liquidity on the cash accounts of the Payment Bank to repay the credit. In normal situations, the Payment Banks have repaid all intraday credit operations with the Central Banks before the auto-collateralisation reimbursement is initiated. If this is the case, T2S executes only a cash sweep during which the excess liquidity on the payment bank's cash accounts is transferred to the relevant Real-Time Gross Settlement (RTGS) systems. If, however, there is not sufficient liquidity on the cash account at the end of the day to fully reimburse the pending intraday credit, special end of day procedures are invoked.

The securities that are held on the accounts of the Central Bank (or pledged) for auto-collateralisation purposes are transferred to the overnight collateral Security Account indicated by the Central Bank. At the same time, the relevant Collateral Management System (CMS) is informed of the move and the credit usage limit for the participant in the RTGS system is increased. This process ensures that the T2S service provides, though a collateralised credit, the same amount of liquidity in the RTGS system as it withdraws<sup>5</sup>.

**4.7. T2S SD.SETT 070: Realignment service**

When T2S matches a pair of settlement instructions, or receives an already matched pair of instructions, it verifies whether the instructions submitted require realignment instructions on accounts other than those of the T2S Parties submitting the instructions (e.g. on the accounts of the Issuer CSD). If T2S identifies a need to realign, it generates the required realignment instructions, on the basis of the cross-CSD links in the Common Static Data, automatically validates the realignment instruction, and links all settlement instructions to ensure all-or-none settlement.

---

<sup>5</sup> Further details especially on the reimbursement procedures and rules can be found in the User detailed Functional Specifications, especially chapter 1.1.2 Liquidity management, and in the General Functional Specifications (GFS), especially chapter 2.3.5 Liquidity Management

**Schedule 5 – T2S Service Description**

---

If the Issuer CSD is within T2S and the Investor CSDs are not in T2S, the realignment takes place in T2S on the basis of settlement instructions (usually free-of-payment) to be sent by the Issuer CSD.

T2S does not send realignment instructions to the Issuer CSD if the Issuer CSD is outside T2S:

- The realignment process is handled by the Investor CSDs in coordination with the Issuer CSD outside T2S.
- If at least one Investor CSD is within T2S, the Conditional Securities Delivery (CoSD) mechanism can be used by the Investor CSDs, to block the position in T2S and hold the instruction until the settlement is confirmed in the Issuer CSD's books.

**4.8. T2S SD.SETT 080: Instruction recycling service**

Recycling occurs in anticipation of finding the required securities and/or cash subsequent settlement runs, so that failed transactions can be settled successfully.

Recycling differs slightly depending on whether it occurs during day-time and night-time settlement. In case of night-time settlement, all unsettled settlement instructions are recycled automatically to the next settlement sequence. In day-time settlement, unsettled settlement instructions are recycled when new settlement resources (i.e. securities and/or cash) become available.

Unmatched pending instructions are recycled for 20 days before cancellation by T2S. Matched pending instructions which fail to settle are recycled for a definite recycling period, after which they are cancelled by T2S (see UDFS for further details on the recycling period and its value).

The T2S settlement optimisation techniques reduce the number of unsettled settlement instructions at the end of the settlement day (EOD).

**4.9. T2S SD.SETT 090: Instruction amendment service**

T2S Actors may amend only process indicators, irrespective of the status of the underlying settlement instruction (except for instructions with an end-of-life status). The instructing T2S Party has to cancel and reinstruct the settlement if it wishes to modify any other fields.

T2S allows the amendment of the following process indicators until settlement occurs:

- partial settlement (only for settlement instructions)
- linking instructions
- settlement priority

In case of partially settled instructions, the instructing T2S Party may amend the settlement priority only for the pending part of partially settled instructions.



**Schedule 5 – T2S Service Description**

---

T2S does not allow any settled or cancelled settlement instruction to be modified.

T2S will reject an amendment sent by a CSD participant other than the T2S Party which submitted the original instruction concerned, or its CSD, if the instruction to be amended was sent as non-modifiable by the CSD or an authorised CSD participant.

T2S informs the instructing T2S Party, as well as any T2S Actor duly authorised to access this information, immediately after the successful amendment of an instruction, in accordance with their message subscription preferences.

If the amendment process fails in T2S, then the amendment instruction is rejected. (e.g. original instruction has settled.)

**4.10. T2S SD.SETT 100: Instruction cancellation service**

Any instructing T2S Actor or its CSD may cancel its settlement instructions unilaterally prior to matching or its settlement restrictions prior to settlement. In such case, T2S verifies that (a) the instruction that the T2S Actor wishes to cancel exists in T2S and that (b) its cancellation is possible. Whether or not T2S Actors are able to cancel their instructions depends on the status of the instruction.

T2S will reject any cancellation request sent by a CSD participant other than the T2S Party which submitted the original instruction concerned, or its CSD, if the instruction to be cancelled has been sent as non-modifiable by the CSD or an authorised CSD participant

Under the same rules, a CSD may cancel any instruction of any of “its DCP”. Cancellation instructions cannot be cancelled.

Until matching has occurred, T2S allows a T2S Actor to request unilaterally the cancellation of settlement instructions only.

Once matching has occurred, T2S Actors may cancel matched settlement instructions only bilaterally, i.e. both parties must send a cancellation instruction (“binding matching”) for the cancellation to take effect. T2S then matches the cancellation instructions and cancels both settlement instructions.

In the case of bilateral cancellation of settlement instructions, T2S checks whether the cancellation instruction from the counterpart exists and matches the two cancellation instructions. If the counterpart cancellation instruction does not exist, then the cancellation instruction remains pending until it matches with a valid counterpart cancellation instruction. T2S also accepts already matched cancellation instructions to cancel an instruction previously sent as already matched.

In the case of a Conditional Settlement (CoSD), T2S allows only the administering T2S Party identified in the Common Static Data to unilaterally request the cancellation of the instruction that triggered the CoSD process (e.g. when the external condition for settlement is not fulfilled),

**Schedule 5 – T2S Service Description**

---

even after T2S has blocked the relevant securities holding for a CoSD. If a CoSD involves more than one administering T2S Party, the CoSD settlement instruction cannot be cancelled unless T2S receives cancellation instructions from each administering T2S Party involved in the initial settlement instruction.

T2S notifies the originator of a cancellation instruction when the cancellation instruction has either been executed (i.e. cancellation of the settlement instruction was successful) or denied (i.e. settlement instruction could not be cancelled). In the latter case, the resulting cancellation status value for the cancellation instruction is “denied”.

If the cancellation process in T2S fails, then the cancellation instruction goes through recycling until it is either processed or rejected if the original instruction has already settled.

If the cancellation mechanism is automatically activated by T2S for a given instruction, T2S informs the CSD or the DCP that the instruction was cancelled by T2S. Automatic cancellation rules are applied to invalid or unmatched or failed/outdated instructions, and are compliant with ECSDA recommendations.

Realignment instructions cannot be cancelled by any T2S Actor.

**4.11. T2S SD.SETT 110: Hold/release service**

Hold and release mechanisms allow T2S Actors to hold or release settlement instructions until their actual settlement or cancellation, even beyond their Intended Settlement Date (ISD). These mechanisms give T2S Actors the flexibility to delay the settlement. T2S Actors may send maintenance instructions to hold and release settlement instructions as many times as required.

T2S allows only the T2S Actor that has put an instruction on hold to release it. If there are two executed hold instructions for the same instruction (i.e. one from the CSD participant and one from the CSD), release instructions must also come from both. If T2S receives a hold instruction for a settlement instruction that is already on hold or has been cancelled from the same T2S Actor who has submitted the initial hold or cancellation instruction, T2S denies the hold instruction.

T2S will reject any hold/release instruction sent by a CSD participant other than the T2S Party which submitted the original instruction. or its CSD, if the instruction to be held/released was sent as non-modifiable by the CSD or an authorised CSD participant

All instructions on hold at the end of the ISD remain unsettled and T2S recycles them in accordance with the T2S rules for recycling instructions. Furthermore, T2S allows the remaining part of partially settled instructions to be held and to released.

T2S will reject any hold or release settlement instruction if T2S has already settled or cancelled the underlying settlement instruction. T2S informs the instructing T2S Party accordingly, depending on its message subscription preferences.

**Schedule 5 – T2S Service Description**

---

**4.12. T2S SD.SETT 120: Earmarking, blocking and reservation service****4.12.1. T2S SD.SETT 121: Earmarking service component**

In T2S Parties may define that a security position or a security account be earmarked as a settlement restriction. For a position or an account to be earmarked, the securities must be fully available in the relevant account.

Earmarking defines that a security position or security account may be used for one and only one defined purpose. An earmarked position or account can not be used for another purpose unless the earmarking is revoked.

A T2S Actor may earmark a position or an account for a specific purpose such as auto-collateralisation. If there is a conflict regarding use of the earmarked securities for a delivery/receipt owing to contradictory choices between account level and instruction level (that is to say when a settlement instruction refers to a earmarking purpose which is different from that at account level), the choice at account level overrides the choice at position level (T2S will credit or debit the earmarked position according to the purpose at account level and not according to the purpose at the instruction level). If earmarking is done at the Security Account level for a specific purpose, it will not be possible to earmark securities at position level (in the same account), for a different purpose.

Earmarking is not possible for DCAs.

**4.12.2. T2S SD.SETT 122: Blocking service component**

In addition to earmarking, T2S Parties may block securities or cash using settlement restrictions. Also via a static data maintenance it is possible to block securities account, DCA and Party in order to prevent settlement. A T2S Actor may block securities or cash for a specific purpose. For the securities or cash to be unblocked, the relevant instruction must contain the reference to the specific purpose.

A blocking of cash or securities prevents the transfer of specific securities/cash from a specific Security Account/T2S DCA.

When a blocking restriction is submitted for settlement, and providing sufficient securities and/or cash are available on the relevant accounts, T2S blocks the number of securities and/or the amount of cash specified in the settlement restriction on the relevant securities and/or T2S DCA(s). If insufficient securities and/or cash are available, the blocking will be recycled until full settlement can occur

**4.12.3. T2S SD.SETT 123: Reservation service component**

As a further settlement restriction, T2S Parties may reserve securities or cash. A T2S Actor may

**Schedule 5 – T2S Service Description**

---

create a reservation without having all the securities or cash specified in the reservation. Any securities or cash arriving will be attributed to the reservation until the reserved volume has been reached.

When a reservation instruction is submitted for settlement, and providing sufficient securities and/or cash are available on the relevant account(s), T2S reserves the number of securities and/or the amount of cash specified in the settlement instruction on the relevant securities and/or T2S DCA(s). If insufficient securities and/or cash are available, T2S:

- reserves the securities and/or the cash already available on the relevant account; and
- supplements it with any incoming securities and/or cash proceeds arriving on this account, provided that the latter are not defined to be used for any other purpose.

A reservation of cash or securities reserves a securities or cash position for the settlement of one or more settlement instructions. A T2S Actor may refer to an existing reservation in another settlement instruction, by means of the reservation's unique reference number. If such references result is made the provisioning process will include the reserved cash or securities in its provisioning check. The reserved securities/cash will be used first (ahead of unreserved securities/cash) for settlement of the instruction.

**4.12.4. T2S SD.SETT 123: Common features of the earmarking, blocking and reservation service component**

When several reservations/blockings of securities and/or cash have been performed on the same Security Account and/or T2S DCA, and a T2S Actor submits to T2S a settlement instruction referring to one (or some) of those reservation/blocking instructions, the T2S provision-check does not consider the additional securities and/or cash reserved/blocked through reservation instructions other than those referred to in the instruction being settled. However, if the securities/cash reserved/ blocked are not sufficient, T2S also takes into account additional securities and/or cash available on the relevant Security Account and T2S DCAs, provided that the latter have not been reserved/blocked for any other purpose.

If at EOD the reserved and blocked cash has not been used for any purpose, T2S releases the relevant cash. In case of a CoSD blocking, T2S releases the blocked cash at the EOD and creates a new CoSD blocking instruction. As regards securities, if blocked or reserved securities have not been used or released at EOD as a result of an instruction from the relevant T2S Actor, T2S does not release them automatically.

**4.13. T2S SD.SETT 140: Conditional Security Delivery (CoSD) service**

Conditional Security Delivery (CoSD) is a special functionality which manages instructions that require the fulfilment of a settlement condition outside T2S before securities may be settled in

**Schedule 5 – T2S Service Description**

---

T2S<sup>6</sup>.

It is the responsibility of the CSD to set up, maintain and administrate the CoSD rule based model and process. These rules are stored as part of the Common Static Data in T2S. Each rule identifies an administering T2S Party to release the instruction for settlement or to cancel the CoSD flagged settlement instruction and determines events which will result in an instruction automatically being submitted to the CoSD functionality by T2S. One settlement instruction might be subject to more than one CoSD rule and in such cases more than one administering T2S Party is assigned to that instruction.

On the ISD, T2S verifies all instructions with that particular ISD in accordance with the CoSD rules. It submits them automatically to the CoSD procedure if one or more CoSD rules are met. In such case, T2S automatically generates a settlement restriction to block the securities position, the cash position, or both.

T2S rejects any cancellation request coming from the instructing parties after the activation of the CoSD process, as only administering parties are allowed to cancel settlement instructions submitted to CoSD.

T2S blocks the securities in the deliverer's Security Account irrespective of the instruction to which the CoSD rule applies (similar rule applies for cash blocking on the T2S DCA linked to the receiver's Security Account). If two or more CoSD rules apply to the securities delivery instruction or related receiving or realignment instructions and those rules require securities to be blocked, the securities are blocked only once. Likewise, T2S blocks cash only once in the delivering cash account.

In a CoSD, securities, cash or both remain blocked and the instruction concerned remains on hold until T2S receives from the administering parties:

- a release instruction, requesting settlement of the instruction using the previously blocked securities or cash (on the basis of the information contained in the initial instruction); or
- a cancellation instruction. After receiving cancellation instruction(s) from all administering parties T2S will cancel the CoSD instruction and its underlying instructions. In such case the underlying cash/securities are unblocked and the administering parties and instructing parties receive a confirmation message.

A “blocking” status message is sent by T2S to inform the (administering) CSD and/or the DCP that the securities, cash or both have been blocked for the processing of the original instruction. A “hold” status message is sent by T2S to inform the (administering) CSD and/or the DCP that the

---

<sup>6</sup> Further details can be found in the User Detailed Functional Specifications (UDFS), especially chapters 1.1.1. Settlement, 2.4 Send Settlement Restriction on Securities Position, 2.6 Send Release Instruction for CoSD by Administering Party, and 2.7 Send Cancellation Instruction for CoSD by Administering Party

**Schedule 5 – T2S Service Description**

---

instruction related to the original instruction is prepared for settlement and waiting for release.

Only the administering T2S Party can send the release message. If the receiving party is outside T2S, the status information is relayed by the CSD responsible for the account within T2S.

If the CoSD blocking cannot take place, T2S recycles the blocking instruction for the following Settlement Day. Cash blocked under CoSD is released at the EOD and regenerated for the following Settlement Day. Settlement instruction that are on CoSD Hold are recycled for the following Settlement Day (i.e. securities remain blocked and the settlement instruction remains on hold).

If the realignment chain changes or revalidation of the instruction submitted to CoSD and its related instructions is unsuccessful, T2S cancels all the instructions but the blocked securities/cash remain blocked.

**4.14. T2S SD.SETT 150: Linked instructions service**

T2S Actors may link instructions in order to ensure that a settlement instruction settles at the same time, before or after another settlement instruction. Linked instructions are possible on a

- one-to-one,
- one-to-many, or a
- many-to-many

basis.

When T2S submits several linked instructions for a settlement attempt, it posts the debits and credits for cash and securities from the relevant transactions if the provision check (including account netting effects) is successful. T2S settles sets of linked instructions according to the highest level of priority accorded to any of the instructions within the set (the whole set of linked instructions settles according to this level of priority).

T2S Actors can link instructions by using the ISO settlement link indicators “AFTER”, “BEFORE” and “WITH”. These link indicators will be used in the settlement process. It is also possible to link by using a pool reference, which behaves from a settlement point of view as a WITH link. In addition, the T2S actors can use the INFO link, which has no impact on the settlement processing.

When T2S receives an instruction which is linked to one or more other instruction(s), it:

1. checks that the linked instruction(s) exist.
2. then validates that the information contained in the new linked instruction is consistent with the instruction which exists and to which it is linked, i.e. the ISD and the Security Account holder used are the same.

Linked instructions are excluded from partial settlement. If at EOD a linked instruction has not

**Schedule 5 – T2S Service Description**

---

been settled it will be recycled.

**4.15. T2S.SD.SETT 160: Corporate actions service**

To support the CSDs in settling corporate action entitlements, T2S uses standard settlement services for security settlement as well as liquidity management/cash settlement.

**4.16. T2S.SD.SETT 170: Penalty Mechanism service**

Regulation (EU) 909/2014 (CSDR), mandates the implementation of a settlement discipline framework that includes obligations for CSDs to establish procedures that facilitate and promote timely settlement of transactions. These procedures include the application of cash penalties for matched settlement instructions that have not settled on their Intended Settlement Date (ISD). In order to support CSDs in their compliance to the CSDR, T2S provides a Penalty Mechanism service that consists of three service components:

- Cash penalties identification service component
- Cash penalties computation service component
- Cash penalties adjustment service component

Note: the settlement of cash penalties, i.e. collection and re-distribution of the payments related to cash penalties, is out of scope of the T2S Penalty Mechanism service.

**4.16.1. T2S.SD.SETT 171: Cash penalties identification service component**

The initial process in the T2S Penalty Mechanism service is the identification of settlement instructions eligible for cash penalties, performed on a daily basis by T2S, i.e. every Settlement Day.

The application of cash penalties is restricted to a specific scope of:

- Financial instruments: a list of securities eligible for cash penalties is maintained in T2S. CSDs are responsible to feed and maintain this list in T2S on a daily basis.
- Transaction types: all transactions types can be eligible for cash penalties, except transactions for the settlement of corporate actions on stock.
- Instruction types: all settlement instruction types sent by T2S actors are in scope of cash penalties, i.e.:
  - DVP/RVP: deliver or receipt against payment;
  - DWP/RWP: deliver or receipt with payment;
  - DFP/RFP: deliver or receipt free of payment;
  - DPFOD/CPFOD: payment free of delivery debit or credit.

**Schedule 5 – T2S Service Description**

---

T2S generated realignment settlement instructions as well as all Intra-Position and Intra-Balance restriction movements are out of scope of cash penalties.

- Instruction lifecycle: only matched settlement instructions are considered for cash penalties. Additionally, in order to derive whether a cash penalty is to be computed, T2S performs further eligibility checks taking into account the ISD, applicable settlement cut-off, statuses and reasons for non-successful settlement of the settlement instruction, as well as the details of the counterpart matched instruction.

In line with the CSDR, T2S distinguishes between two types of cash penalties:

- Settlement Fail Penalties (SEFP): penalise a non-execution or failure of settlement after the completion of the settlement processing of the relevant cut-off on or after ISD. A SEFP is computed for each Settlement Day where the settlement instruction fails to settle in T2S. Every reason for non-successful settlement associated to the settlement instruction (and not to the counterpart instruction) is considered by T2S for its eligibility for a SEFP, it does not matter whether a settlement instruction has failed to settle for e.g. lack of securities or lack of cash, or if it has not been submitted to settlement due to e.g. being on hold.
- Late Matching Fail Penalties (LMFP): penalise the late sending of settlement instructions that prevents timely settlement of a transaction. Only one LMFP can be calculated for a given settlement instruction, i.e. on the Settlement Day when it is matched in T2S, but it considers all the previous days where the instruction did not settle due to the late matching of the instruction. A settlement instruction is eligible for a LMFP when it is matched in T2S at a point in time when it is no longer possible to settle it on ISD and has an accepted timestamp in T2S greater than its counterpart instruction.

For each cash penalty identified, T2S determines the failing and the non-failing party, respectively the party to be debited with the penalty and the party to be credited with the penalty. This information is stored in T2S and used for reporting purposes. T2S uses the following logic to derive the failing party for a cash penalty:

- As a general rule, the T2S Actor specified as account operator (as described in “Security Account data service”) of the securities account of the underlying settlement instruction for which the cash penalty is computed is considered as the failing party, whereas the non-failing party will be the T2S Actor specified as account operator of the securities account of the counterpart’s settlement instruction, except;
- In case the cash penalty is a LMFP and the settlement instructions are sent to T2S as already matched, T2S will consider the instructing party of the underlying already matched instruction as both the failing and the non-failing party, as T2S cannot derive which counterpart is responsible for the late matching. This logic is implemented under



**Schedule 5 – T2S Service Description**

the assumption that the instructing party is best suited to reconcile and re-allocate the penalty to the correct client with information available outside T2S. The instructing party shall request its CSD to re-allocate the cash penalty in T2S with the ad-hoc functionality (see “Cash penalties adjustment service component”).

**4.16.2. T2S.SD.SETT 172: Cash penalties computation service component**

T2S performs the computation of cash penalties applicable for every Settlement Day on the following Settlement Day. Once it has determined that a settlement instruction is eligible for LMFP or SEFP, T2S computes the amount of cash penalties according to parameters defined for each T2S instruction type as summarised in the following table (see UDFS for further details):

Type of Settlement Instruction	Parameters used for the computation of cash penalties
Delivering versus Payment (DVP) Delivering Free of Payment (DFP) Receiving Free of Payment (RFP)	Penalty based on the reference price of the ISIN, quantity of securities failed to be delivered, and penalty rate of the relevant asset type.
Receiving versus Payment (RVP)	Penalty based on the reference price of the ISIN, quantity of securities failed to be delivered, and the cash penalty rate (discount rate of the relevant currency).
Debiting Payment Free of Delivery (DPFOD) Crediting Payment Free of Delivery (CPFOD)	Penalty based on the amount of cash failed to be delivered and the cash penalty rate (discount rate of the relevant currency).
Delivery with Payment (DWP) Receiving with Payment (RWP)	Penalty will be the sum of: - The penalty based on the reference price of the ISIN, the quantity of securities failed to be delivered, and penalty rate of the relevant asset type, and; - The penalty based on the amount of cash failed to be delivered and the cash penalty rate (discount rate of the currency).

For the computation of a LMFP, T2S considers each Settlement Day where the settlement instruction was due to settle according to the T2S calendar, i.e. since the ISD. Hence, the LMFP shall be the sum of the amounts calculated for each of the relevant Settlement Days identified,

**Schedule 5 – T2S Service Description**

---

using the reference prices of the applicable day.

T2S computes the amount of cash penalties in T2S settlement currencies:

- For settlement instructions against payment, in the currency of the cash leg of the transaction. If the reference price of the ISIN is in a different currency, the Euro foreign exchange rates of the ECB are used to convert the penalty.
- For settlement instructions free of payment, in the currency of the reference price of the ISIN as long as it is a T2S settlement currency and in Euro otherwise. If the reference price of the ISIN is in a currency that is not a T2S settlement currency, the Euro foreign exchange rate of the ECB are used to convert the penalty.

Newly computed cash penalties are then made available to the relevant T2S Actors in push or pull mode via the daily penalty list (See “Report Generation service”) as soon as the calculation process is performed. Each cash penalty is informed twice, once for the failing party (with debit indicator) and once for the non-failing party (with credit indicator). It includes cash penalty identification and details except price data, as well as underlying settlement instruction details. Newly computed cash penalties are also available in User-to-Application (See “Query Service for CSDs service component”) once all the daily calculation and recalculation process have finished.

**4.16.3. T2S.SD.SETT 173: Cash penalties adjustment service component**

T2S provides the possibility to CSDs to perform adjustments on computed cash penalties for a given month, until the end of the appeal period on the following month (as further detailed in the UDFS). CSDs are able to perform the following actions in User-to-Application or Application-to-Application mode:

- Remove a cash penalty;
- Re-include a previously removed cash penalty;
- Re-allocate a cash penalty from the instructing party to the delivering or receiving party;
- Switch the failing and non-failing party of a cash party;
- Update erroneous reference data that was used for the computation of a cash penalty, e.g. the reference price or the attributes of an ISIN eligible for penalties

In all except the first case (removal), T2S automatically recalculates cash penalties impacted by the adjustment(s), which is then made available to the relevant T2S Actors in push or pull mode via the list of modified cash penalties (See “Report Generation service”), or in User-to-Application (See “Query Service for CSDs service component”) as soon as the recalculation process is performed. T2S performs the recalculation of cash penalties on a daily basis, i.e. every Settlement Day.

## 5. T2S SD.LIM: Liquidity Management Service Class

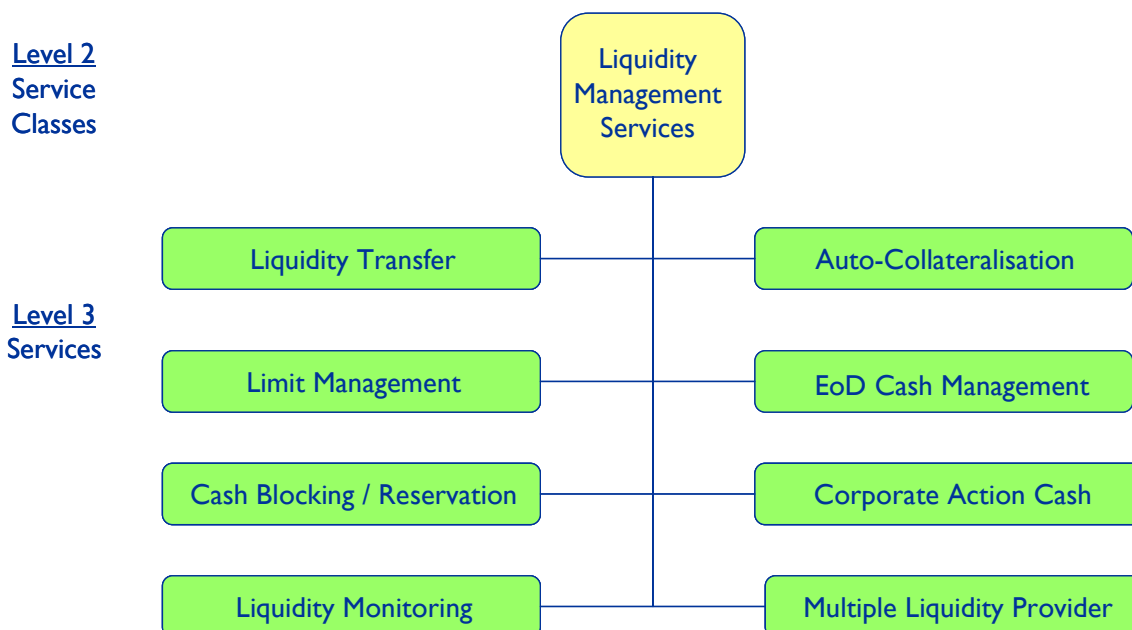

### 5.1. T2S SD.LIM 010: Liquidity transfer service

A liquidity transfer in T2S is an instruction from a DCA holder to transfer a specified amount of cash balance from its cash account to another cash account. The T2S DCA holders are Payment Banks or Central Banks.

T2S allows a T2S DCA holder to receive liquidity on its T2S DCA(s) from any RTGS account (provided that they are denominated in the same currency and that this is permitted by the relevant Central Bank). In the same way, T2S allows the holder of the T2S DCA to send liquidity from its T2S DCA(s) to any RTGS account (as setup by the relevant Central Bank in T2S) if the currency is the same.

In addition to liquidity transfers between RTGS accounts and T2S as mentioned above, T2S provides T2S DCA holders with a “multiple liquidity providers” functionality, i.e. T2S DCA holders can receive liquidity from and reimburse to several RTGS accounts.

Liquidity transfers are executed in real time upon receipt. During the execution of the liquidity transfer, if the status of the liquidity transfer order changes, T2S informs the T2S Actor about the new status if the latter’s message subscription rules in the Common Static Data so dictate.

Schedule 5 – T2S Service Description

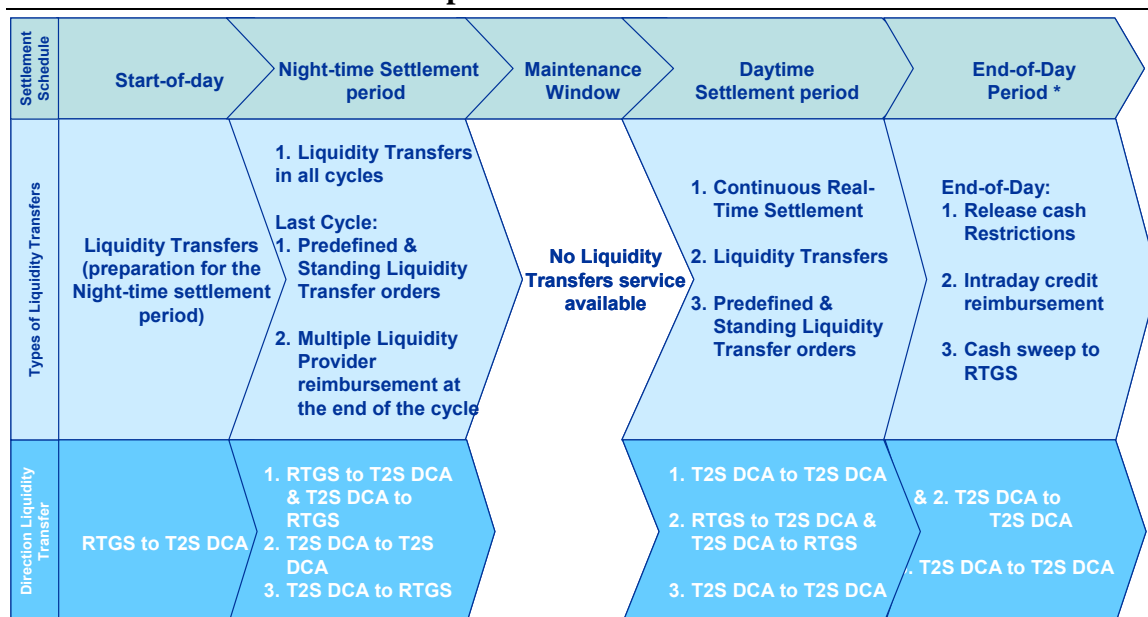

T2S supports three types of liquidity transfers between T2S DCAs and RTGS cash accounts and between T2S DCAs.

- Immediate liquidity transfer order:
  - Liquidity is transferred in real time on receipt of the instruction from the account holder or a T2S Party with the appropriate rights.
  - Used to transfer liquidity between a T2S DCA and the RTGS account or between two T2S DCAs (if these DCA belong to the same Payment Bank or are linked to the same RTGS account)
  - If an immediate liquidity transfer order cannot be settled, an alert is sent to the Payment Bank that initiated the transfer in line with the message subscription rules in the Common Static Data.
  
- Pre-defined liquidity transfer order:
  - Liquidity is transferred at a certain time or when a particular business event occurs, as defined by the account holder of the account or a T2S Actor with appropriate rights to debit the account.
  - The transfer is executed only once on the basis of a defined time or event
  - Liquidity is transferred from a T2S DCA to an RTGS account only (either the specified transfer amount or “all cash” available in the T2S DCA will be transferred)
  - Any duly authorised T2S Actor may amend or delete the predefined liquidity transfer order
  
- Standing liquidity transfer order:

**Schedule 5 – T2S Service Description**

---

- Liquidity is transferred at a certain time or when a particular business event occurs, as defined by the account holder of the account or a T2S Party with appropriate rights to debit the account.
- The transfer is executed whenever the event in question occurs until the standing order is deleted.
- Liquidity is transferred from a T2S DCA to an RTGS account only (either the specified transfer amount or “all cash” available in the T2S DCA will be transferred)
- Any duly authorised T2S Actor may amend or delete a standing liquidity transfer order.

If insufficient liquidity is available on the accounts to be debited, T2S allows partial execution in the case of pre-defined/ standing liquidity transfers. T2S allows a partial execution of an immediate liquidity transfer only if it is instructed to do so by a Central Bank in its role as RTGS system, or by a CSD acting on behalf of the Payment Bank.

As part of the business validation process, T2S checks that the content of immediate liquidity transfer orders (received from T2S Actors) or liquidity transfers (which have been generated from a standing or predefined liquidity order) is correct, and validates the consistency of the data contained in the immediate liquidity transfer received by T2S with the Common Static Data. A liquidity transfer which has been generated from a standing or predefined liquidity order is not validated by T2S.

After business validation, T2S communicates the acceptance/ rejection of a liquidity transfer order to the Payment Bank and to the Central Bank if the liquidity transfer order was sent from the RTGS system. In the event of failure or rejection, T2S sends a list of error/ reason codes. T2S also communicates all changes in status of a liquidity transfer order.

After successful validation the liquidity transfer order is sent to the settlement functionality for processing. The booking function updates the balances on the DCAs involved on a gross basis. In the case of partial execution or of no execution, no further settlement is attempted. T2S communicates all changes in status of a liquidity transfer order in the course of its execution in accordance with the message subscription rules in the Common Static Data, and confirms all executed transfers between T2S and RTGS.

**5.2. T2S SD.LIM 020: Limit management service**

T2S provides the T2S Actor with different liquidity control mechanisms. A Central Bank can control its parties' T2S DCA by setting an auto-collateralisation limit for the T2S DCA. Payment Banks can also set different limits at the client level and monitor their utilisation. A Payment Bank can set up different limits for the liquidity provided to each of its clients, either

## Schedule 5 – T2S Service Description

against collateral or without collateralisation. Using T2S queries, the Payment Bank has a consolidated view of its client’s collateral holdings at any given point in time across multiple Security Accounts in either the same or different CSDs. The respective limits are automatically updated when used as a part of the settlement process. T2S performs validations to ensure that these limits are not breached. T2S does not allow cash movements between the Cash Payment Bank and its clients in T2S. The only cash in T2S is the cash on the DCA, which is in CeBM.

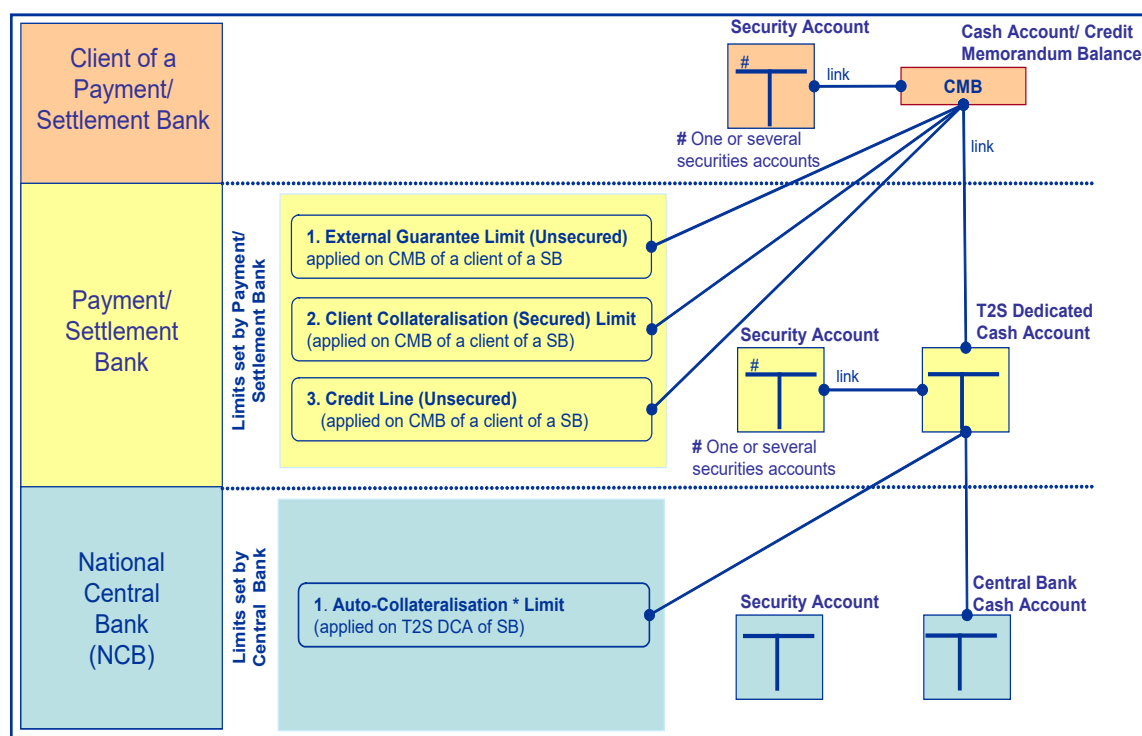

Central Banks and Payment Banks can set and monitor the limits they provide to their clients.

- **External guarantee limit:** Cap on credit secured outside T2S that the Payment Bank sets for its client. The external guarantee limit and the unsecured credit limit are identical from the T2S viewpoint, except for the sequence in which they are triggered. Usage of the external guarantee limit is triggered before client-collateralisation.
- **Client-collateralisation limit:** Cap on the amount of credit extended against securities by a Payment Bank in T2S
- **Unsecured credit limit:** Cap on the amount of credit granted by a Payment Bank (generally unsecured outside T2S)
- **Auto-collateralisation limit:** Cap on the amount of credit extended against securities by a Central Bank to the Payment Bank.

T2S ensures that all the required provision checks for the Payment Banks and their clients are performed simultaneously and that collateralisation operations are initiated on the basis of the results of the provision check. A Cash Payment Bank client’s credit exposure as well as the

**Schedule 5 – T2S Service Description**

---

availability of sufficient headroom on different types of credit limits is determined solely on the basis of information available to T2S.

To prepare for client collateralisation, the T2S actor has to provide and to set up the information required for the link between its Security Account and its DCA, and to provide the necessary information for the Credit Memorandum Balance (CMB) Security Account Link Set and CMB Security Account Link<sup>7</sup>.

Furthermore, a T2S Actor can control the use of liquidity by reserving/ blocking cash for specific instructions. The amount of cash reserved/ blocked may not be used to settle instructions, unless the instruction being settled refers to the initial reservation/ blocking instruction.

**5.3. T2S SD.LIM 030: End of day (EOD) cash management service**

After the cut-off of settlement processing, the EOD processing is conducted in three steps. Information messages are sent to the initiating T2S Actor and other duly authorised T2S Actors in accordance with their message subscription preferences:

1. EOD release of unused cash restrictions:
  - All restrictions on cash (blocked cash, reserved cash) are released for the current Settlement Day
  - New cash settlement restrictions regarding CoSD blocking are created for the next Settlement Day
2. EOD release of auto-collateralised positions and transfer of cash balance:
  - The amount of outstanding auto-collateralisation is validated
  - If there is no pending auto-collateralisation: No action is taken
  - If there are pending auto-collateralisation(s):
    - and the cash on the T2S DCA is sufficient to reimburse fully the pending auto-collateralisation, including possible cash rebalancing: T2S reimburses
    - and there is insufficient or no cash on the T2S DCA to reimburse the pending auto-collateralisation, T2S:
      - checks for available cash via cash rebalancing from another DCA of the same T2S Actor
      - releases the associated reverse (unwind) settlement instructions previously

---

<sup>7</sup> Further details can be found in the User Detailed Functional Specifications (UDFS), especially chapter 1.1.2 Liquidity management

**Schedule 5 – T2S Service Description**

---

created

- creates instructions for positions that will not be released (equivalent to the pending amount of auto-collateralisation that cannot be reimbursed out of T2S), to transfer the collateral to the Central Bank overnight collateral Security Accounts, and
  - Rebalances the account to zero.
3. EOD liquidity transfer (cash sweep)
- Liquidity transfers are created for all T2S DCAs and the Central Bank Account used for EOD reimbursement with non-zero cash balances.
  - These liquidity transfers are settled in T2S and sent to the RTGS system.

**5.4. T2S SD.LIM 040: Corporate action cash service**

T2S enables a T2S Actor, receiving cash proceeds from corporate actions on its T2S DCA, to specify whether T2S should keep the cash proceeds on the T2S DCA or to retransfer them from the T2S DCA to the RTGS account (outside T2S) with which the T2S DCA is linked.

In such case, the T2S Actor must define a standing liquidity transfer order for the T2S DCA as part of the Common Static Data to be able to opt for an automated retransfer of cash proceeds to an RTGS account.

T2S allows the T2S DCA holders to use different T2S DCAs for the settlement of the cash leg of trading-related instructions and for the settlement of the cash leg of corporate action instructions.

During both the daytime Real-time settlement and night-time batch settlement T2S executes the standing liquidity transfer order as an immediate liquidity transfer to transfer the corporate action proceeds to the RTGS account of the T2S Actor.

T2S also provides this setup and service for retransferring ‘monetary policy Repo’ related cash proceeds from a T2S DCA to an RTGS account.

**5.5. T2S SD.LIM 050: Cash blocking and reservation service**

T2S allows a T2S Party to use restrictions to block or to reserve a cash balance in a T2S DCA. For that purpose the CSD or the Central Bank has to define the relevant restriction types as part of the Common Static Data.

Blocking a cash balance involves preventing the transfer of a specified amount of funds in a specific currency in one cash account to any other cash account by linking it to a specific purpose. Blocking in T2S never results in a negative cash balance, i.e. it is not possible to block an amount of funds greater than the available cash balance on a cash account.

Reserving a cash balance prevents the transfer of a specified amount of funds in a specific



**Schedule 5 – T2S Service Description**

---

currency in one cash account to any other cash account except for the purpose for which the funds were reserved. The settlement of the underlying settlement instruction (for which the funds were reserved) results in the actual transfer of the reserved funds to another cash account and the subsequent removal of the reservation.

A T2S Actor may reserve a cash position without yet disposing of the required full amount of cash in that position. Any cash arriving in the reserved position will be attributed to the reservation until the required amount has been reached.

A T2S Actor may refer to an existing reservation/blocking in another settlement instruction, by referring to the unique reference number of the reservation's/blocking. Such reference will be interpreted in such a way that the provisioning process includes the reserved/blocked amount of cash in its provisioning check. The reserved/blocked cash will be used first (ahead of unreserved/unblocked cash) for settlement of the instruction.

During business validation, T2S checks automatically whether one of these restriction types applies to the submitted settlement instruction or to an instruction for an intra-position movement to determine the further processing required. If the validation process finds a match for a restriction type, then the relevant restriction type is applied to the instruction.

**5.6. T2S SD.LIM 060: Liquidity monitoring service**

T2S provides different functions for monitoring the actual cash balances of the DCAs as well as the CMB limits to monitor the liquidity of the clients of the Payment Bank. T2S calculates the amount of cash required for the settlement and informs the T2S Actor if more liquidity is needed.

Cash related queries allow duly authorised T2S Actors to obtain information about their account balance on the T2S DCA(s), outstanding intraday credit from auto-collateralisation, and potential liquidity based on securities on stock that can be used for auto collateralisation purposes. In addition, T2S provides information showing the overall liquidity.

A T2S Actor may request information on cash needs for instructions pending for settlement during the current Settlement Day, as well as cash forecasts for the following Settlement Day. Information on cash needs and cash forecasts covers T2S DCA liquidity needs.

Information for the on-going Settlement Day is intended to provide a snapshot of the cash required to settle instructions remaining unsettled at the moment of the snapshot. This information includes (as part of the cash required for the current day settlement) the value of potentially available auto-collateralisation.

Information on cash forecasts for the following Settlement Day and in particular for the following night-time settlement window is intended to allow T2S Actors to prepare and dedicate in advance sufficient cash for the settlement of their instructions during the following night-time settlement window. The cash forecasts are based on

**Schedule 5 – T2S Service Description**

---

- cash needs resulting from the net balance between
  - cash proceeds and
  - cash needs
  - expected for settlements with the following day as the ISD, and
- the amount of intraday credit that can be obtained through auto-collateralisation.
- the amount of liquidity credit that can be obtained through external guaranteed limits and unsecured credit lines from Payment Banks or Central Banks

Depending on the chosen report configuration, cash forecasts can be received as reports sent out automatically by T2S at certain points/when certain events occur during the Settlement Day. Preliminary information on cash can also be obtained via the query functionality.

However, it should be noted, that these cash forecasts (received through the above-mentioned reports and via queries) are only indicative of the final cash needs, as the forecasts are based only on the information available in T2S: T2S does not take corporate action proceeds into account, if the relevant instructions are not submitted to T2S.

The T2S Actor has to be aware that these cash forecasts will change in the course of the Settlement Day depending on new settlement instructions/ liquidity transfers submitted to T2S. It is to be expected that the quality of the cash forecast will increase continuously during the day as additional settlement instructions and information become available in T2S.

A T2S Actor is able to define the floor and ceiling amounts per DCA in the Common Static Data. This functionality allows the T2S Actor to receive alerts if the amount of liquidity in the DCA reaches the minimum/maximum the DCA account holder has defined.

**5.7. T2S SD.LIM 070: Multiple liquidity provider service**

T2S DCA holders may receive liquidity from several RTGS accounts (i.e. from different liquidity providers) and use the proceeds in T2S. This cash can be transferred from the RTGS accounts prior to the start of Batch Settlement in T2S. Subsequently, a T2S DCA holder can use this cash for its own settlement purposes or to provide cash settlement services to its clients, during Batch Settlement in T2S.

At the end of the Batch Settlement, a T2S DCA holder may opt to establish liquidity transfers which will reimburse its different liquidity providers in the relevant RTGS systems with the remaining cash in the T2S DCA. This reimbursement facility is the “multiple liquidity provider” service.

The reimbursement of cash is executed via outbound liquidity transfers generated by T2S on the basis of the multiple “standing liquidity transfer order”. The priority of execution is defined by the T2S Actor in the “order link set” setup in the Common Static Data.

**Schedule 5 – T2S Service Description**

---

T2S validates whether a T2S DCA holder (liquidity receiver) has opted for a “multiple liquidity provider” service for reimbursement. If this is the case, T2S reimburses the liquidity providers in the sequential order of liquidity providers as set up in the order link setup (in the Common Static Data). T2S aims to reimburse each liquidity provider up to the maximum amount of the cash the liquidity provider transferred before starting to reimburse the next liquidity provider in the sequential order concerned. In the order link set, the main liquidity provider is setup as the last liquidity provider and therefore is the last liquidity provider to be reimbursed (assuming there is sufficient cash to reimburse all liquidity providers).

## 6. T2S SD-STD: Common Static Data Management Service Class

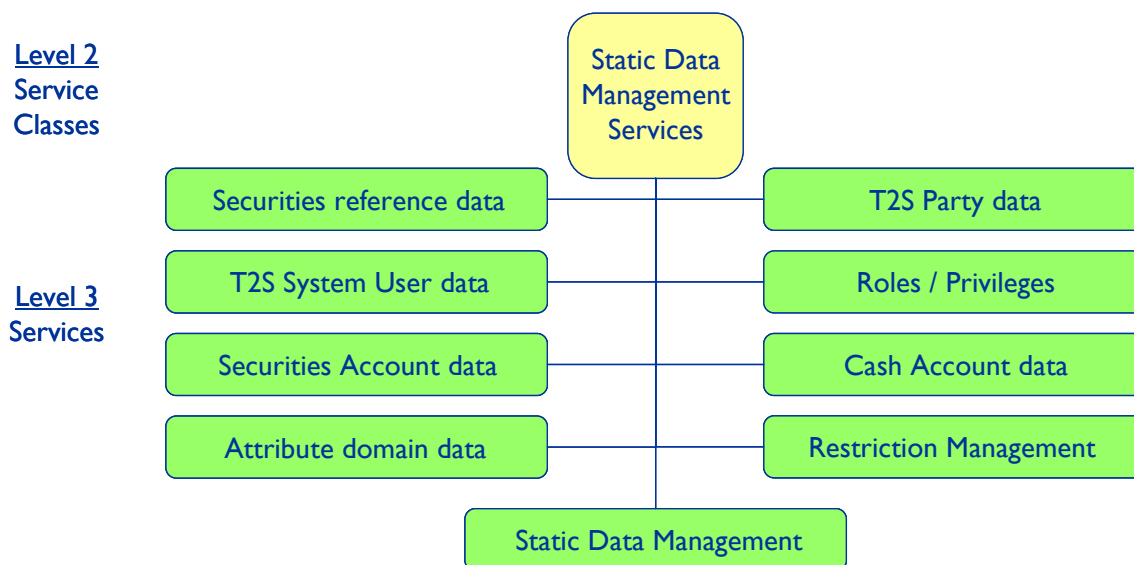

### 6.1. T2S SD.STD 010: Common Static Data management service

Common Static Data management is the service that T2S provides for setting up/inserting, changing/maintaining and inactivating/deleting Common Static Data in T2S regardless of the type of conceptual entity. T2S applies the same functional principles for inserting, maintaining and deleting all entities.

T2S processes all Common Static Data updates in real-time in both User-to-Application (U2A) and Application-to-Application (A2A) mode, except in the case of some preliminary functions which are only available in U2A mode<sup>8</sup>. All Common Static Data entities are stored in the T2S data base with a full audit trail and it is possible to query the actual occurrence of an entity as well as the historical data. Whenever a record in Common Static Data is changed, a new version of this record is stored including the timestamp and the identification of the T2S Actor performing the change, thereby maintaining a full audit trail.

T2S allows T2S Actors to parameterise the entities and the types of updates made by a T2S User or by a T2S process. In general, T2S will process these in real-time except during the Maintenance Window (see UDFS for further information). T2S checks for every change in a Common Static Data entity and for the change approval configuration for this entity and processes the update in accordance with the configured parameters. The privileges of the different T2S Users depend on the Common Static Data entity. Static security data changes made

<sup>8</sup> The detailed list of available functions for the different modes are part of the UDFS and of the UHB.

**Schedule 5 – T2S Service Description**

---

by an automated interface do not require an independent change approval by a second user, but a manual update by a person is subject to such approval (4-eyes principle).

T2S provides duly authorised T2S User with the functionalities to

- identify all static and dynamic data changes awaiting approvals;
- search for specific static and dynamic data changes;
- search and display historic change information, including both approved and rejected changes;
- and approve and reject static and dynamic data changes.

**6.1.1. T2S SD.STD 011: Insert service component**

T2S allows the duly authorised T2S User to insert a new occurrence of an entity into Common Static Data. A T2S User is an individual or application that is allowed to communicate with T2S when duly authorised and authenticated.

**6.1.2. T2S SD.STD 012: Update service component**

T2S allows duly authorised T2S User to update an existing occurrence of a Common Static Data entity. T2S allow T2S Users to update occurrences of a Common Static Data entity if the previous update of the same occurrence remains in the change approval queue. T2S prohibits the concurrent update of occurrences of a Common Static Data entity. When a T2S User selects an occurrence for editing, T2S locks the occurrence so that a second T2S User or T2S process cannot access it for updating.

**6.1.3. T2S SD.STD 013: Delete service component**

When a duly authorised T2S User initiates the deletion of an occurrence in a Common Static Data entity, T2S checks that there are no unsettled instructions and only zero positions pertaining to that data. Only if that is the case will the deletion status of the occurrence be changed from “active” to “deleted”. The deletion of an occurrence of a Common Static Data entity occurs only logically.

The T2S archiving functionality is the only function which will physically delete an occurrence of a Common Static Data entity from the active T2S database. The physical deletion of a Common Static Data occurrence is only possible for logically deleted occurrences. To ensure the referential integrity of data, Common Static Data occurrences are physically deleted from the active database only after archiving processes have removed and archived the related transactional and position data as of a cut-off date that is determined by the retention plan. Data history and data revisions that took place before the archive date will be included in any physical

**Schedule 5 – T2S Service Description**

---

deletion process even if the current record is still active - since the transactional data for which they are relevant would be removed by the archiving.

**6.1.4. T2S SD.STD 014: Reactivate service component**

In some instances, it is necessary to reactivate a logically deleted occurrence of Common Static Data. T2S allows duly authorised T2S Users to specify the Common Static Data entity and the identifier of an occurrence in that Common Static Data entity, and to reset the deletion status of an occurrence in that Common Static Data entity from “deleted” back to “active”.

**6.2. T2S SD.STD 020: Securities Reference Data service**

Securities Reference Data in T2S defines the set of entities and attributes that T2S requires for settlement and auto-collateralisation in CeBM, as well as the calculation of cash penalties

The Securities Entity holds all attributes that exist only once for a security. Securities Reference Data require every security to have an ISIN code, compliant with ISO 3166. The creation of a new security will be effective immediately unless it requires dual entry approval. This also applies to updates of all attributes for the Securities Entity. Certain “non-standardised securities” that comply with all required criteria apart from not being fungible from a settlement perspective may still be entered in and processed by T2S.

The Securities Reference Data Service allows the CSD to create and maintain the Common Static Data of those securities for which it is the Securities-Maintaining Entity. In addition, the non-SME CSDs may maintain Market-Specific Attributes on securities for their market. The service allows the Issuer CSD to block or unblock ISINs both for itself and its Investor CSDs. T2S allows an Investor CSD to block or unblock ISINs.

For the purposes of cash penalty calculation, the Securities Reference Data Service requires each SME CSD to provide the list of securities subject to cash penalties and the related daily prices, as well as a liquidity indicator for certain types of financial instruments; In addition to Securities Reference Data for which the SME CSD is responsible, other mandatory data related to the applicable penalty rates for cash and securities including a list of relevant trading venues is maintained by the T2S Operator, while the ECB is responsible for the input of the daily euro foreign exchange reference rates.

**6.3. T2S SD.STD 030: T2S Party data service**

T2S deploys a flexible hierarchical party model to allow CSDs and Central Banks to manage their accounts and parties in an efficient way. The T2S Operator maintains the first and second level of the hierarchy. All other levels must be managed by the CSDs and the Central Banks

Schedule 5 – T2S Service Description

respectively.

A T2S Party denotes any legal or organisational entity required in T2S as single legal entity to guarantee data segregation. The same legal entity, or organisational unit of a legal entity, may be set-up under several CSDs or Central Banks as a result of this principle. This entity includes the parties from the first three levels of the hierarchy model, the T2S Operator, the CSDs, the participants of the CSD, the Central Bank and Payment Banks. It also establishes the links between the different parties on the different hierarchical levels. A CSD can also be a T2S Actor for its own purposes defined in level 3 of the hierarchy as a CSD participant (see graph below).

T2S assigns each party a technical identifier, which the user can also use as the unique T2S Party code (participant code). T2S will use the BIC of a T2S Party to identify the T2S Party uniquely across in the Central Bank - and CSD-specific reference data.

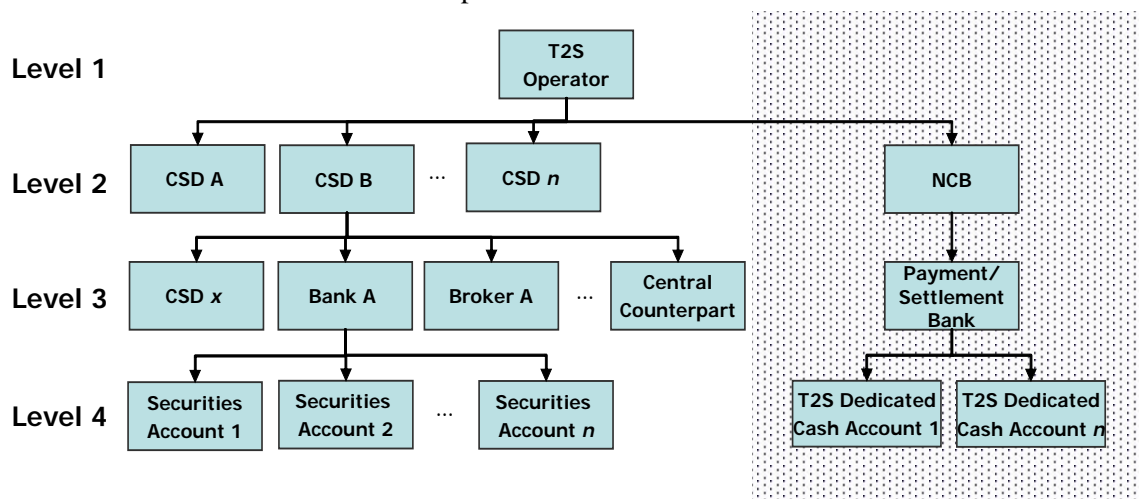

The CSD-part of this hierarchical structure contains all T2S Party data pertaining to securities settlement. The Security Account (on the lowest level of this part of the hierarchy) is assigned to the CSD participant and to the CSD. Some specific account types are assigned to level 2 parties for example a Mirror account. Each CSD is responsible for maintaining the hierarchy including the Security Accounts of the different parties which are linked to it. CSDs assign and manage the access rights of their participants, including those of all their DCPs.

Security Accounts linked to the CSD participant and T2S DCAs linked to a Payment Bank form the lowest level of the hierarchy. The Security Accounts assigned to level 3 parties can for instance be omnibus accounts or DCAs.

CSDs have access to Central Bank party and account Common Static Data to link Security Accounts to T2S DCAs for the settlement of the cash leg of a settlement instruction. T2S will make available to the CSDs the relevant data for the linking of accounts without publishing all T2S DCAs. Access rights control which CSD is able to see the T2S DCAs needed for linking purpose. When a CSD sets up a Security Account, it can only see those T2S DCAs to which it can link a Security Account for settlement.

The Central Bank part of the hierarchical structure includes all data relating to the Central Bank

Schedule 5 – T2S Service Description

and the T2S DCAs held with the Central Bank by Payment Banks. In the third tier of this part of the hierarchy includes the Payment Banks which operate T2S DCAs to provide liquidity. The T2S DCAs are the lowest level of the hierarchy. The hierarchy links the T2S DCA to the relevant Central Bank.

Central Banks authorise the access to T2S DCAs by assigning the BIC of those parties, eligible for access to the cash account for settlement, to the T2S DCA. When entering a Security Account, the CSD only sees those T2S DCAs which have the same BIC assigned to them as the T2S Party that owns the Security Account.

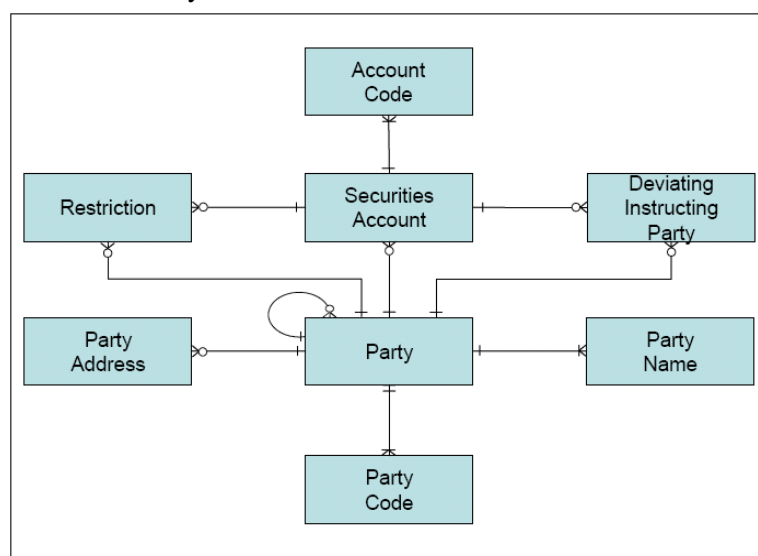

6.4. T2S SD.STD 040: Security Account data service

Security Account reference data specify all information required for defining and processing a Security Account in T2S.

Security Accounts in T2S must be opened and closed by the CSD to ensure the consistency and integrity of Security Account reference data between the CSD and T2S. When the CSD opens an account, it must immediately trigger the opening of the relevant account in T2S. The same applies for the closing of an account.

T2S supports a T2S Actor - Security Account Relationship entity to specify a time-dependent relationship between a T2S Actor and a Security Account. The purpose of the entity is to allow a CSD in T2S to transfer a Security Account relationship from one account operator/sub-custodian to another account operator/sub-custodian within the CSD. The functionality enables a CSD to transfer an end-investor Security Account relationship from one account operator to another.

CSDs are also responsible for closing a T2S Security Account by setting the business status to “closed” and confirming the change. T2S only closes an account if:

- there is no un-settled instruction specifying the T2S Security Account for the settlement;
- the T2S Security Account is not part of an active T2S link set;



**Schedule 5 – T2S Service Description**

---

- there is no securities balance remaining on the T2S Security Account.

In case an unmatched instruction exists concerning an account that is closed, during the business revalidation the unmatched instruction is identified and will be cancelled.

**6.5. T2S SD.STD 050: Cash account data service**

The T2S DCA model specifies the requirements for assigning T2S DCA to Security Accounts for the settlement of the cash leg of settlement instructions. The T2S DCA entity specifies the T2S DCAs of Payment Banks in T2S. It also links the T2S DCA to the associated RTGS account concerned as well as establishing the reference link to the Payment Bank that owns the account and to the Central Bank that operates the account.

The key responsibilities of each Central Bank whose currency (euro and non-euro) is available for settlement in T2S are:

- set-up and maintain the DCAs of their RTGS participants for all securities-related payment transactions in their currency in T2S;
- identify securities accounts for use as the pledged accounts to which securities are moved in auto-collateralisation
- set up and manage Common Static Data, access rights and configuration data pertaining to its members and its own participation in T2S;
- if required, provide for the interoperability of their own RTGS systems and collateral management (CMS) systems with T2S;
- if the Central Bank chooses to participate in auto-collateralisation:
  - to provide auto-collateralisation in its currency to its members in accordance with its self-defined eligibility criteria;
  - if required, to provide to T2S, for the specific purpose of auto-collateralisation, a list of eligible securities and prices as well as any other data necessary for T2S to judge the eligibility of a specific security for a specific participant;
- be responsible for the choice of its network provider(s) and to make every effort to maintain properly functioning connectivity to T2S functions properly.

Central Banks are also responsible for closing a T2S DCA by setting the business status to “closed” and confirming the change. Unless the Central Bank deems that immediate closure is necessary, T2S only closes an account if:

- there is no unsettled instruction specifying the T2S DCA for the settlement of the cash leg;
- the T2S DCA is not part of an active T2S DCA link set;

**Schedule 5 – T2S Service Description**

---

- there is no cash balance remaining on the T2S DCA.

The external RTGS Account Entity specifies all the external RTGS payment accounts to which an authorised T2S User can link a T2S DCA. This entity also provides the reference link to the Payment Bank that owns the account and the Central Bank that operates the account.

The Central Banks have to add new external RTGS account for a Payment Bank or another Central Bank in T2S. T2S assigns new external RTGS accounts an opened business status and the current Settlement Day as the opening date.

An external RTGS account can be closed by setting the business status to “closed” and confirming the change. T2S will not close an account if:

- there is an unsettled payment instruction specifying the external RTGS account;
- the external RTGS account has an active link to a T2S DCA;
- or if the external RTGS account is defined in a current (not closed, not expired) standing liquidity transfer order.

T2S allows the blocking/unblocking of an RTGS account using T2S Actor and account settlement restrictions. The blocking of an RTGS account results in all T2S DCA linked to the RTGS account being blocking from settlement.

**6.6. T2S SD.STD 060: T2S User data service**

A T2S User is an individual or application that is allowed to communicate with T2S using a login name and certificate/smartcard and for U2A in addition an optional password and/or certificate for authentication. The assignment of the T2S User to a T2S Actor establishes the relationship between the T2S User and the system entity. T2S provides specific roles and privileges to restrict the access of this T2S User to business data of the CSDs and of the Central Banks.

T2S User maintenance defines the process of adding, changing and deleting users in T2S. Access to this functionality is restricted to system administrators only.

A system administrator is able to lock and unlock a T2S User without deleting the user by setting the attribute "lockout status" to "yes" or "no". If the system administrator assigns existing roles to or deactivates roles for a T2S User, T2S automatically assigns to the T2S User the privileges associated with that role.

**6.7. T2S SD.STD 070: Roles and privileges data service**

In order to comply with the principle concerning the separation of functions and roles, T2S implements roles and privileges as business concepts which refer to the right of T2S Actors to interact with T2S. Duly authorised system administrators configure roles and privileges to authorise other T2S Users to execute specific functions or view specific data.

**Schedule 5 – T2S Service Description**

---

A privilege is a right, either granted or denied, to execute certain functions within T2S, or to access and/or update certain data in T2S. It is through the privileges that access to functionality and data for specific roles is granted and restricted to T2S Actors. A privilege is uniquely identifiable, both internally in the application and to the T2S system administrator. Privileges are classified either as System privileges or Object privileges.

System privileges grant certain rights for a single or a homogeneous group of data objects. Object privileges grant rights in relation to a single or a group of Common Static Data objects.

The administrator grants a privilege by specifying whether (1) the associated functionality is allowed or explicitly denied; (2) the grantee of the privilege is allowed to grant the same privilege to another user or role; (3) the grantee of the privilege is allowed to use the function associated to the privilege in accordance with the two-eye or four-eye- principles.

Account owners (i.e. a CSD or a Central Bank) may grant privileges to their clients, with different roles and privileges for each one. These roles and privileges can be differentiated by client and even among different accounts of the same client.

T2S privileges may for example grant:

- no access at all;
- read only access;
- the right to instruct with possible limitations concerning the type of instructions or the accounts to instruct on.

A role consists of one or more privileges. A CSD or a Central Bank may configure valid roles for its T2S parties as follows:

- If set up by the CSD, DCPs manage their T2S User administration,
- If set up by the Central Bank, Payment Banks manage their T2S User administration.

Each CSD or a Central Bank needs to create and authorise a system administrator for each of its client T2S Actor of that CSD or of that Central Bank. The system administrator is responsible for maintaining users and roles for this particular client. The CSD or Central Bank administrator has to ensure, that the system administrator of the T2S Party has access only to those roles that the CSD or Central Bank permits. Accordingly, T2S enables each CSD or the Central Bank to grant its clients access to a different set of roles, depending on the services provided by the CSD or the Central Bank to each T2S Party.

CSDs or Central Banks participating in T2S must continue to comply with legal and regulatory requirements. T2S therefore allows the configuration of CSD- or Central Bank - specific roles. The CSDs or Central Bank may differentiate the access they grant to T2S services and functions on the basis of the regulatory and legal requirements to which they are subject.

**Schedule 5 – T2S Service Description**

---

**6.8. T2S SD.STD 080: Restriction management service**

T2S must support the T2S Operator, CSDs and Central Banks by enabling them to provide specific validations and processing of settlement instructions to fulfil legal, regulatory and supervisory requirements in the markets that they service. T2S therefore allows the T2S Operator, CSDs and Central Banks to define their own restriction types.

Restriction types are attributes that define the specific processing characteristics for a securities position, cash balance, Security Account, T2S DCA, T2S Party or settlement instruction to ensure configurability of specific requirements, as prescribed by national legal and regulatory requirements and practices, and to avoid hard-coding in the application software.

T2S provides the following restriction processing types:

- Blocking – blocks an instruction from settlement;
- Rejection – rejects an instruction at validation;
- CSD Validation Hold – accepts a settlement instruction at validation (not applicable to settlement restrictions) but holds it for a subsequent release by the CSD<sup>9</sup>;
- Reservation – reserve a cash balance or securities position;
- Balance Type / Earmarking – define and manage position types for securities and balance types for cash balances;

Restrictions can also be defined as either a positive or negative parameter set and in time (from and to).

During the validation process, T2S automatically verifies whether one of the defined restrictions applies to the instruction submitted.

A T2S User may define specific rules for restriction types. These define the sequence in which T2S applies a logical set of parameters to determine whether a specific restriction applies to the instruction. The restriction matrix defines the specific parameter values within a rule. T2S stores matrix entries for a rule in a rule set. A matrix entry defines an occurrence of a valid set of values, specifying the actual criteria against which T2S must validate a settlement instruction to determine whether a restriction type applies.

T2S allows duly authorised users to

- add new rules for a restriction type;
- (re-) define the sequence of rules for a restriction type;

---

<sup>9</sup> Further details for the CSD validation hold are provided in the User Detailed Functional Specifications (UDFS) chapter 1.1.1 Settlement

**Schedule 5 – T2S Service Description**

---

- delete rules for a restriction type if the user has deleted all occurrences under that rule;
- add and delete matrices in a rule.

This functionality is also used by CSDs to define which settlement instructions will be put on CSD Validation Hold. It allows CSDs to execute certain tasks / validations locally prior to the settlement of the underlying instruction.

**6.9. T2S SD.STD 090: Attribute domain data service (market-specific attributes)**

Attribute domains in T2S provide the valid list of values allowed for an attribute (table column or a data field in physical terms). They include a list of all the valid values that a user can enter for an attribute of a static or transactional data entity. T2S uses attribute domains for field validations and for documenting the business definition of a value in an attribute.

T2S provides a general Common Static Data component that allows the duly authorised T2S User to logically create, modify and deactivate market-specific attribute domains, on the basis of the existing data definitions (attributes). These market-specific attribute domains allow the T2S Operator, CSDs and Central Banks to define their own restriction types as described above. T2S allows the definition of additional values, mapped to an attribute,

T2S limits the actions that a user can trigger in the database using attribute domain management. T2S allows the registration and deactivation of attribute domains using pre-defined database tables.

## 7. T2S SD. INF: Information Management Service Class

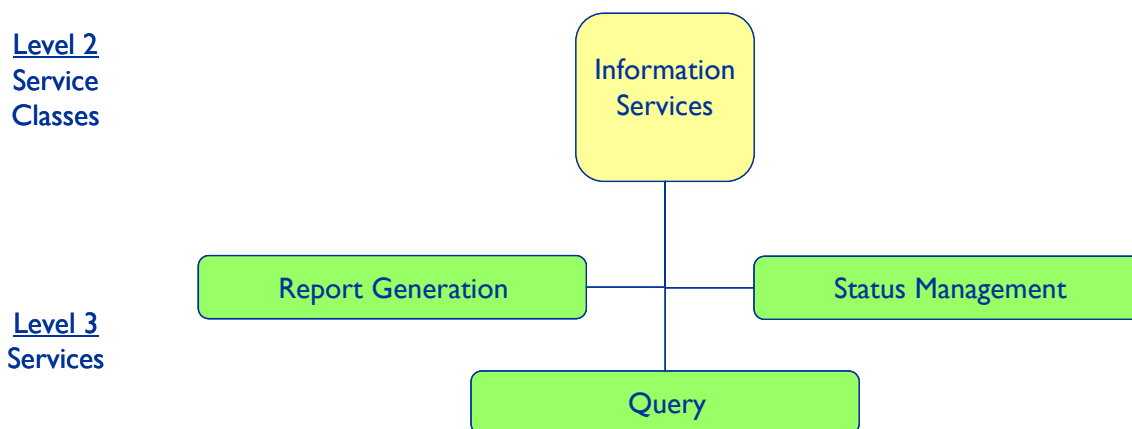

### 7.1. T2S SD.INF 010: Status management services

As part of its settlement services, T2S maintains the settlement statuses of any instruction it processes. T2S informs duly authorised T2S Actors of the result of all settlement services and of all changes to the statuses of instructions, depending on the message subscription chosen by the T2S Actor.

T2S provides multiple-statuses reporting that gives more flexibility and brings more efficiency than single-status reporting. In this context, T2S provides the values of the different statuses for each instruction in a report or query response. Status messages report the status that has changed.

If instructions are rejected, settlement attempts unsuccessful or instructions cancelled, T2S also informs the relevant T2S Actor why this has happened.

### 7.2. T2S SD.INF 020: Report generation service

T2S provides a defined set of reports. Reports are triggered automatically by T2S. All reports are available in both User-to-Application (U2A) and in Application-to-Application (A2A) mode as in the T2S Connectivity Services description. These reports are not, and should not, be considered as Regulatory Reports. T2S Actors may use the query services described hereafter to receive the necessary information from T2S to provide their regulators with the required information.

T2S reports are either event-triggered or sent at a fixed time. When a CSD, T2S Actor or Central Bank require information at a time not so triggered, the information can also be retrieved using the query service.

Reports containing information either on individual accounts or on a set of accounts can be sent to the relevant CSDs and DCPs, or to the relevant Central Bank. T2S reports are based on the latest available data and contain a date and time stamp. In addition, T2S sends successive versions of defined reports with the information that changed from the previous version to the

**Schedule 5 – T2S Service Description**

---

next version of that report (delta reporting). The additional information includes the attributes of the reported items as provided in the previous version of the report.

A DCP may receive reports only on:

- its own securities and cash balances, those of its clients and those of any other T2S Actor for which the appropriate authorisation was granted,
- instructions that were submitted by the T2S Actor (or a Third Party with access rights - supported by power of attorney to do so on behalf of the T2S Actor) and instructions that refer to the securities or cash account of the T2S Actor (or any sub-account thereof),
- cash penalties (and their aggregated monthly amounts) that are either charged or credited to the DCP; and
- its own Common Static Data, as well as some generic Common Static Data on instruments and the daily schedule.

A CSD may receive reports only on:

- instructions that were submitted by the CSD in T2S itself, its DCPs, or by its participants,
- securities transactions and balances of the CSDs own accounts in T2S, those of its DCPs and those of its participants;
- cash penalties (and their aggregated monthly amounts) that are either charged or credited to itself or to its participants; and
- Common Static Data of the CSD in T2S itself, its DCPs, and of its participants, where privileges permit. These Common Static Data include those ISINs for which the CSD acts as Security Maintaining Entity (SME)<sup>10</sup>. Additionally, a CSD may query all Common Static Data that relate to its admission rule, for securities as well as for parties.

A Central Bank may receive reports only on:

- Instructions that were submitted by the Central Bank in T2S itself, or by its Payment Banks.
- cash balances of its own DCAs in T2S and those of its Payment Banks as well as cash movements on its own DCAs and those of its payment banks, and
- Common Static Data of the Central Bank in T2S itself, and of its Payment Banks. Additionally, a Central Bank may query all Common Static Data that relate to its national currency.

---

<sup>10</sup> Further details can be found in the Manual of Operational Procedures (MOP)

**Schedule 5 – T2S Service Description**

---

A Payment Bank may receive reports only on:

- Instructions that were submitted by itself.
- cash balances of its own DCAs in T2S, and
- its own Common Static Data, and that pertaining to its DCAs.

T2S provides the following report types (non-exhaustive, a full list can be found in the UDFS):

- Statements of holdings
- Transaction reports:
  - Statement of transactions
  - Statement of pending instructions
  - Statement of settlement allegements
  - Statement of Security Accounts at EOD
  - Statement of changes to Common Static Data
  - Billing data report
- Cash forecast reports
  - Current Settlement Day cash information
  - Following Settlement Day cash forecast
- Cash Penalties reports:
  - Daily Penalty List;
  - List of Modified Penalties; and
  - Monthly Aggregated Amounts of cash penalties.

**7.3. T2S SD.INF 030: Query service**

T2S allows information to be queried in T2S. Queries are triggered by the duly authorised T2S Actor. All queries are available in User-to-Application (U2A) and a subset is available in Application-to-Application (A2A) mode (see UDFS for further detail). All securities instructions, and balances and Common Static Data queries are available for all CSDs in T2S, DCPs as well as Central Banks and Payment Banks, in accordance with to the access rights.

Additionally, cash penalties queries in User-to-Application (U2A) are available for all CSDs in T2S in accordance with the defined access rights.

T2S accepts all queries at any point in time during T2S opening days. T2S processes all queries in real time, on the basis of the latest available data. During the night-time settlement sequences,



**Schedule 5 – T2S Service Description**

---

T2S queues balance queries sent in Application-to-Application mode while the U2A balance queries will not be processed. T2S responds to the A2A queries at the end of each sequence inside a cycle with the latest position.

T2S provides standard queries which can be taken as the basis (blueprint) for individual, non-standard queries. For individual, non-standard queries, T2S provides the option of specifying parameters in the query to fulfil the needs of the querying T2S Actor. When processing queries, T2S takes into account all access rights as defined in the Common Static Data. T2S will only return results where the T2S Actor that has submitted the query has the right to access the underlying data. CSD/ Central Bank and T2S Parties may act as service providers for indirect Parties or e.g. remote brokers.

**7.3.1. T2S SD.INF 031: Query service for T2S Actor service component**

A T2S Actor may query the following – subject to access rights:

- its own securities positions;
- instructions submitted by the T2S Actor itself (in case of direct connectivity), or by a Third Party that has access rights in T2S supported by a power of attorney;
- its own Common Static Data, as well as some generic Common Static Data relating to e.g. instruments and the daily schedule.

**7.3.2. T2S SD.INF 032: Query service for CSDs service component**

A CSD in T2S may query the following:

- instructions that were submitted by the CSD itself, or by its DCPs;
- securities and cash balances of DCA(s) of the CSD itself and of its T2S parties in T2S;
- cash penalties (and their aggregated monthly amounts) that are either charged or credited to itself or to its participants;
- Common Static Data of the CSD itself, and of its T2S Actors;
- Common Static Data pertaining to securities.

**7.3.3. T2S SD.INF 033: Query service for Central Banks service component**

A Central Bank in T2S (acting in its role as Central Bank) may query:

- cash balances of the DCAs kept at the Central Bank in question;
- movements on the DCAs kept at this Central Bank;
- and Common Static Data pertaining to the DCAs for which it is responsible.

**Schedule 5 – T2S Service Description**

---

Additionally, a Central Bank may act as a T2S Actor of a CSD. In this case, the Central Bank has the same access rights as any other T2S Actor. Finally, if a Central Bank plays the role of a CSD, that Central Bank, when doing so it has the same access rights of a CSD.

**7.3.4. T2S SD.INF 034: Query service for Payment Banks (liquidity providers) service component**

A Payment Bank in T2S (acting in its role as liquidity provider) may query:

- cash balances of its DCAs;
- Common Static Data pertaining to the DCAs for which it is responsible.

**7.3.5. T2S SD.INF 035: Settlement-related queries service component**

During the night-time settlement cycles, T2S stores balance queries sent in Application-to-Application (A2A) mode, then replies with a message that T2S is currently running a cycle and that T2S will respond to the query at the end of the cycle with the latest position.

T2S provides different standard queries related to settlement:

- Securities balance query:
  - The Securities Balance Query returns an account view on the position at a particular point in time, the latest securities position or at the close of settlement if requested after close of settlement, all positions are summarised in the account structure that is compatible with the query parameters.
  - The Securities Balance History Query returns all positions that occurred during a particular time period, all positions are summarised in the account structure that is compatible with the query parameters.
- Settlement instruction query
  - T2S allows T2S Actors to query settlement instructions in accordance with the Actor's roles and privileges.
  - T2S provides a settlement instruction status audit trail query which allows a T2S Actor to query settlement instructions on the basis of the business processing status or a combination of business processing statuses on a specific date or in a specific period in the past

**7.3.6. T2S SD.INF 036: Cash balance-related queries service component**

In accordance with their access rights, Central Banks and settlement/ Payment Banks may query:

- the current balance of one or more T2S DCAs.

**Schedule 5 – T2S Service Description**

---

- the total current collateral value of securities earmarked and available (on stock) for auto-collateralisation for a T2S DCA via the Securities Balance query and the Securities Balance History query. The collateral value of securities, calculated by the query, does not include securities on flow, as the settlement process will use these automatically.
- for a specific T2S DCA, the current total collateral value of every security, earmarked and available (on stock) for auto-collateralisation via the Securities Balance query and the Securities Balance History query, in all Security Accounts, linked to the T2S DCA for settlement of the cash leg. The collateral value of securities, calculated by the query, does not include securities on flow, as the settlement process will use these automatically.
- the amount of outstanding intraday credit stemming from auto-collateralisation, defined as the difference between the credit utilised and the credit reimbursed.
- for a specific T2S DCA, the collateral (amounts and securities) utilised for outstanding intraday credit stemming from auto-collateralisation.
- the total collateral (amounts and securities) utilised for outstanding intraday credit stemming from auto-collateralisation.
- In addition to the queries described above, T2S provides some screens in the T2S Interface (U2A mode) which give a consolidated view of the balances available on the different DCAs of each Payment Bank to facilitate the liquidity management of the treasurer(s) at the Payment Bank itself. These screens are available to directly connected Payment Banks and their Central Bank (further detailed in the User Handbook and the documentation on the GUI interface).
- In order to manage the liquidity of their DCAs, Central Banks and their Settlement/Payment Banks may also query:
  - Limits and their utilisation
  - Liquidity transfer orders
  - Liquidity transfer orders for multiple liquidity providers

A CSD in T2S may query the cash balances of its own DCA(s) and those of its T2S parties in T2S.

### **7.3.7. T2S SD.INF 037: Common Static Data-related queries service component**

Common Static Data queries are related to all main entities in Common Static Data. CSDs and CSDs' participants may query Common Static Data in accordance with their access rights

T2S also provides a Common Static Data audit trail query which allows a T2S Actor (in

## Schedule 5 – T2S Service Description

---

accordance with its access rights) to query all revisions to an occurrence of Common Static Data. Standard Common Static Data queries allow the T2S Actor to query, in accordance with its access rights:

- Security reference data
- T2S Actor reference data
- Security Account reference data
- T2S DCA reference data
- T2S calendar and diary/daily schedule
- T2S entities
- Attribute domains
- T2S Actors, roles and privileges
- Restrictions
- Currency reference data

## 8. T2S SD. CON: Connectivity / Communication Service Class

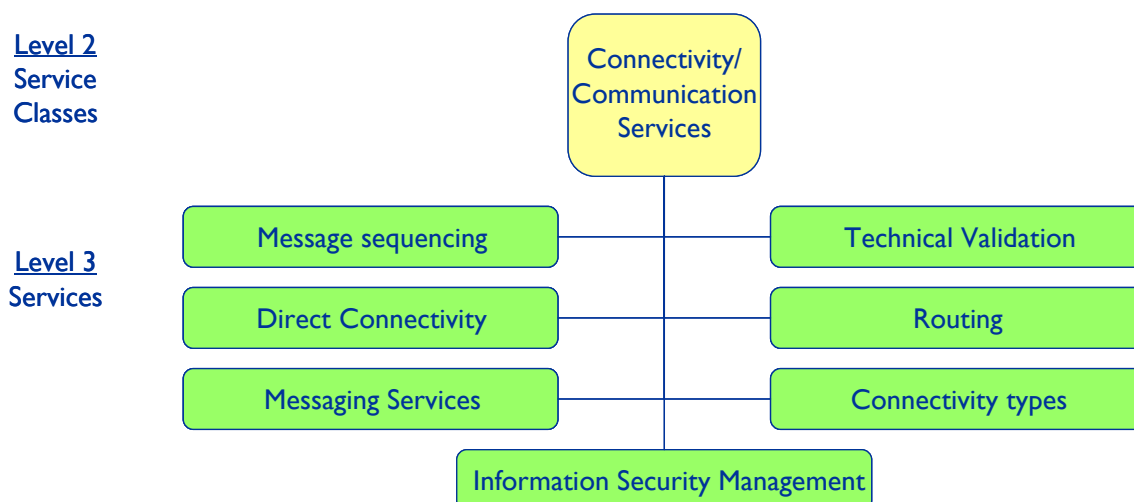

T2S does not provide technical connectivity/network services between the T2S Actors and T2S among its services. Network services have to be procured by the T2S Actors directly from one or more of the accredited Network Service Providers (NSP). T2S defines the technical and operational requirements for the NSPs<sup>11</sup>.

NSPs offer a catalogue of services with appropriate solutions for high settlement volume and small settlement volume T2S Actors. The connectivity service catalogue contains the connectivity to T2S Service NSPs provide and the additional services offered by these NSPs, including;

- detailed services,
- service levels, detailing performances, availability and support commitments,
- volume related services,
- dedicated connectivity solutions,
- backup/ alternative network access solutions.

### 8.1. T2S SD.CON 010: Messaging services

T2S provides standard, time-event-driven and business-event driven messages based on and compliant to the largest extent possible with the ISO 20022 / UNIFI (Unified Financial Industry Message Scheme) standard. Communication between T2S Actors and T2S has to comply with

---

<sup>11</sup> The T2S Connectivity Guide provides further details on the different roles and responsibilities regarding the connectivity services

**Schedule 5 – T2S Service Description**

---

the formats and specifications defined in T2S. T2S supports push and pull mode for files and single messages in Application-to Application mode (A2A), as well as a Graphical User Interface (GUI) in User-to-Application mode (U2A).

In T2S “business terms” a message is a single instruction (e.g. a settlement instruction, matched or unmatched, a Common Static Data maintenance instruction, etc) and in “technical terms” an XML string that refers to one or more “business messages”.

In T2S “business terms” a file is a set of instructions (more than one) and in “technical terms” a XML string that refers to one or more “business messages”, possibly of different types. It’s size should be within a defined range (minimum and maximum considering performance aspects).

For each message or file received by T2S an acknowledgement is sent to the sending T2S Actor. An acknowledgement from the receiving T2S Actor is also expected for each message or file T2S sends out. Security-settlement-related and cash-management-related messages follow the same logic.

Inbound and outbound traffic is stored in T2S in original format messages (before any transformation) and the messages are kept with time-stamping information and signature.

**8.1.1. T2S SD.CON 011: Push messaging service component**

During the Real Time Settlement T2S sends real-time standard messages to the T2S Actors which are triggered by the relevant business events. These events for the generation and subsequent sending of the different messages are described in the corresponding chapters of this Service Description.

After each cycle of the Batch Settlement T2S sends settlement related messages to the T2S Actors. For a given instruction only the most recent valid statuses will be sent. Only settlement-related messages resulting from a night-time settlement sequence are bundled into a file.

Copies are available for a subset of messages and can be received upon subscription by the relevant interested parties (a full list can be found in the UDFS).

T2S message subscription is a service that allows a CSD or another duly authorised T2S Actor with direct connectivity to T2S to subscribe to copies of messages sent between a Directly Connected Party (DCP) and T2S in real-time using push mode messaging.

The T2S Actor must define in Common Static Data message subscriptions for all messages they want to receive. T2S only sends those messages the T2S Actor has subscribed to, there are no mandatory messages apart from the technical acknowledgements, query responses and inbound processing errors (a full list can be found in the UDFS), which are always delivered to the sender of the message. All messages, which are used by T2S, are available for message subscription. T2S will not send any message not subscribed to beforehand, although T2S generates all messages in accordance with the business context.

**Schedule 5 – T2S Service Description**

---

Subscriptions are based on one or more of the following parameters:

- Message type;
- Instruction type;
- Instruction status;
- Participant;
- Account;
- ISIN.

For Central Banks, the messaging service includes i.a.

- messages for each utilisation of intra-day credit stemming from auto-collateralisation.
- messages for each repayment of intra-day credit stemming from auto-collateralisation.

The message subscription rules are defined and maintained in the Common Static Data by the T2S Actor.

**8.1.2. T2S SD.CON 012: Pull messaging service component**

T2S Actors may request to receive specific messages from T2S. T2S uses this mode mainly for query services and reports. Additionally, through the Graphical User Interface (GUI) the T2S Actor may pull queries and reports..

**8.2. T2S SD.CON 020: Technical validation services**

T2S verifies that all inbound communication (messages and files) is compliant with T2S required syntax, format and structure. The message and file integrity check is part of the validation and ensures that only messages and files from T2S Parties enter the T2S applications. T2S validates files using the same standard as for the messages and ensures that inbound files are not lost, that outbound files are neither lost nor duplicated and that the recommendations of the Giovannini file transfer rulebook are applied (generic rules for file construction and best practices for file transfer operations for any and all file transfers, on any network).

If there are structure problems in a received message, T2S rejects the message. If there are file transfer or structure problems inside the file, T2S rejects the file in its entirety. If there are validation problems at the level of individual instructions within the file, the file is normally processed and a rejection message is sent for each individual invalid instruction the file contains.

T2S verifies whether the communication was received from a secured and recognised technical address configured in the Common Static Data.

**Schedule 5 – T2S Service Description**

---

**8.3. T2S SD.CON 030: Connectivity types services****8.3.1. T2S SD.CON 031: Application to Application (A2A) service component**

Application to Application (A2A) mode in T2S is a connectivity mode to exchange information between the T2S software application and application at the T2S Actor. In T2S, A2A can be based on either XML messages or file transfer. The ISO 20022 standard is applied as far as possible, for both inbound and outbound communication.

**8.3.2. T2S SD.CON 032: User to Application (U2A) service component**

The duly authorised T2S User can communicate with T2S via a web based Graphical User Interface (GUI), a connectivity mode to exchange information between software application of T2S and a T2S Actor and which is the User-to-Application interface (U2A) for interaction with T2S. The roles and privileges assigned to a T2S User determine which functions this user may execute and which data this user is allowed to see and to maintain.

**8.4. T2S SD.CON 040: Information security management services**

Information Security management services are a crucial part of the total package of T2S services, in terms of confidentiality, integrity and availability as well as authentication, accountability, non-repudiation and reliability of the T2S information.

Confidentiality or non-disclosure agreements between T2S and the T2S Actors address the requirement to protect Confidential Information using legally enforceable terms. Any access to the service's information by external parties must be controlled. Where there is a business need for working with external parties that may require access to the service's information, or when a product or service is obtained from or supplied to an external party, a risk assessment is carried out to determine Information Security implications and control requirements. Access by external parties to the service's information is not provided until the controls have been implemented and, where feasible, a contract has been signed defining the terms and conditions for the connection or access and the working arrangement.

**8.4.1. T2S SD.CON 041: Authentication service component**

Authentication is a security mechanism which verifies the identity of an individual T2S Actor (the T2S User) or application trying to connect to T2S. A T2S User is an individual or application that is allowed to communicate with T2S using a login name and certificate/smartcard and for U2A in addition an optional password and/or certificate for authentication.

T2S supports different types of authentication:



**Schedule 5 – T2S Service Description**

---

- Simple authentication requires to the T2S User to enter the T2S User ID and the respective password only. This is applicable only for U2A.
- Simple Certificate authentication requires the T2S User to use a certificate without entering a password in T2S. This is applicable only for A2A.
- Advanced Certificate authentication requires the T2S User to use a certificate in addition to entering the T2S User ID and respective password in T2S. This is applicable for U2A only.
- Smartcard authentication requires the T2S User to identify himself to the system using a smartcard in addition to entering the T2S User ID and respective password.

T2S stores and manages certificates as part of the Common Static Data. For every inbound communication T2S verifies

- the identification of the sender
- whether the digital signature of the inbound communication corresponds to the certificate of the sender
- the T2S Actor technical address
- the network service used for the communication
- if the sender information of the inbound communication is defined in the Common Static Data

**8.4.2. T2S SD.CON 042: Authorisation service component**

Authorisation is a security mechanism which verifies that a T2S User or application (trying to connect to T2S) has the appropriate privilege to access certain functions or data within T2S. Authorisation is managed via the roles and privileges assigned by the T2S system administrators. Initially the CSDs and the Central Banks (with respect to the Payment Banks) grant and manage the authorisation. Within a DCP or a Payment Bank, a system administrator may grant additional authorisations which are limited by the authorisation granted to the T2S Actor by the CSD or Central Bank.

T2S verifies the authorisation for every service and data access requested by a T2S User.

**8.4.3. T2S SD.CON 043: 4-eyes principle service component**

T2S ensures that any T2S operation to be executed in 4-eyes-mode is confirmed by a second authorised T2S User. The 4-eyes principle is only possible for U2A communication.

When a T2S User changes any occurrence of static or dynamic data, which is subject to independent approval, T2S creates the changed version of the data as a new occurrence in the

**Schedule 5 – T2S Service Description**

---

relevant revision entity and accords it a status "awaiting approval". The current version remains unchanged and is used until an independent source approves the update. If the independent approver accepts the change, T2S accepts the update and gives it the status "approved" in the Common Static Data entity. T2S retains the previous version of the data from the current entity as part of the audit trail in the revision history.

If the update is not approved, T2S updates the status of the change to "rejected" and it remains as an unapproved change in the revision history.

**8.5. T2S SD.CON 050: Message sequencing services**

T2S assigns each outgoing message a business sequence number which allows all T2S Actors to identify the sequence of messages T2S has sent. The receiving T2S Actors can thus identify whether messages are missing or misplaced in the sequence.

This service is used for all business related messages sent out by T2S.

**8.6. T2S SD.CON 060: Direct connectivity services**

Direct (technical) connectivity is a technical facility which allows T2S Actors to access T2S and use its services without using the relevant CSD/ Central Bank as a relay or proxy. Direct connectivity affects neither the business or legal relationships between CSD and T2S Actor, nor the processing of the instructions of the CSD's or Central Bank's T2S Actor.

Direct connectivity is a technical concept and means the existence of a (direct) A2A network connection between a T2S Actor and T2S. It does not mean that the T2S Actors concerned has any particular roles or privileges.

DCPs have to be certified to participate directly in T2S. The relevant CSD or Central Bank (i.e. the one the DCP is a participant or member of) has to ensure that the DCP fulfils all relevant conditions for participation of the DCP in T2S. T2S ensures that each DCP receives services as authorised by its CSD or Central Bank, and the same Service Levels. Furthermore, T2S ensures that no connected system can harm T2S or any other connected system. Before being able to access the T2S production environment, both the CSD / Central Bank and its DCP(s) therefore have to successfully pass a series of mandatory tests.

An individual T2S Actor may wish to participate as a DCP in more than one CSD or Central Bank. In such case, the T2S Actor is deemed to be a separate DCP within each CSD or Central Bank, and thus has a DCP account and related contractual arrangements with each of the CSDs or Central Banks concerned.

**8.7. T2S SD.CON 070: Routing services**

T2S allows duly authorised T2S Actors to configure routing information which T2S uses to

**Schedule 5 – T2S Service Description**

---

deliver outgoing messages to them. Each T2S Actor can set up several routing conditions and each routing condition includes the network service and the technical address. T2S identifies the T2S Actor entitled to receive the message on the basis of on the configuration in the Common Static Data, namely:

- the message subscription preference of the recipient.
- the technical address to which the message should be routed (when there are multiple technical addresses, the first technical address (according to priority) is chosen).

T2S ensures that outbound messages will be routed to the appropriate technical address of the receiving T2S Actors.

T2S sends a message as a direct response upon receipt of a message, It sends the message to the T2S Actor's technical address, which was used to send the underlying message, rather than the address defined in the Common Static Data.

**9. T2S SD. SUP: Operations and support service class**

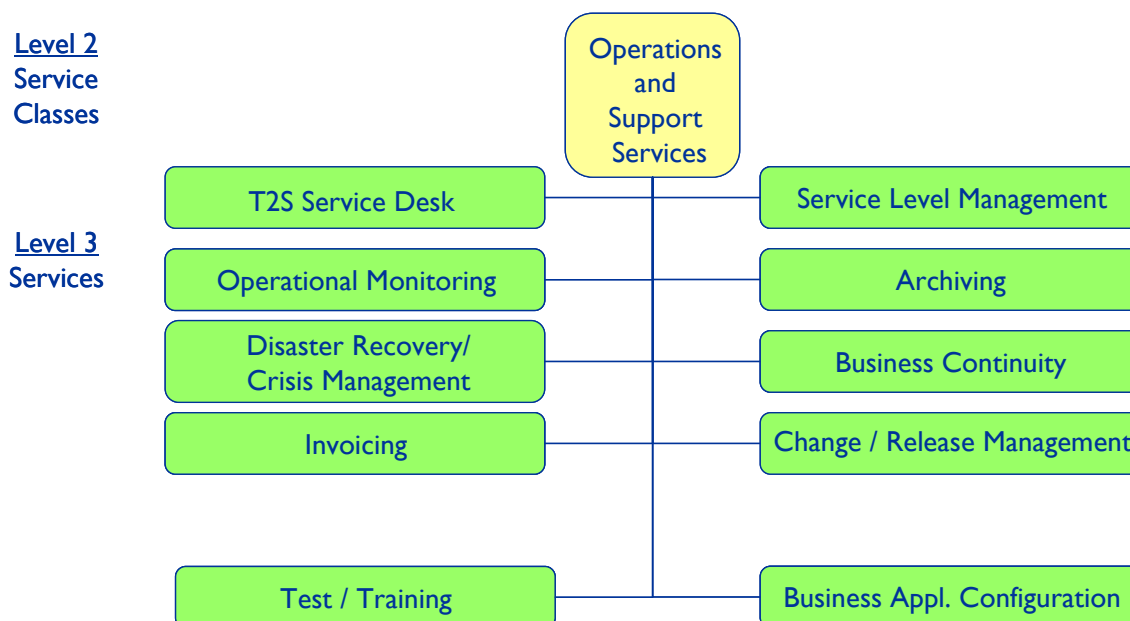

To ensure service support and delivery in accordance with agreed Service Levels, T2S uses predefined processes based on the proven Information Technology Infrastructure Library (ITIL) concept. ITIL provides a set of best practices for managing information technology (IT) infrastructure, development, and operations.

T2S Service delivery is coordinated through the operations and support services and the required activities and processes are delivered and managed in accordance with agreed Service Levels for T2S.

**9.1. T2S SD.SUP 010: Business application configuration services**

T2S ensures the continuous management of its configuration.

**9.1.1. T2S SD.SUP 011: T2S Calendar service component**

For settlement of transactions against payment/delivery and/or free-of-payment/delivery in euro or non-euro CeBM, a common calendar is defined in the Service Level Agreements, as followed by all euro area markets.

During weekends, after the end of the Friday Settlement Day, T2S moves to the Settlement Day of the following Monday and performs the related activities until the end of the night-time settlement period. On the Monday, T2S starts with the preparation of day-time settlement as the

**Schedule 5 – T2S Service Description**

---

continuation of the same Settlement Day<sup>12</sup>.

**9.1.2. T2S SD.SUP 012: T2S Settlement Day service component**

T2S operates on a single harmonised timeframe for centralised settlement procedures in euro and non-euro CeBM. This timeframe represents a balance between the user requirements for a pan-European timetable and the constraints and business needs of existing local schedules, and is in accordance with the market's request for harmonised post-trading practices in the EU.

T2S settlement services are available continuously during the night-time and the day-time settlement periods except for a short period during the Maintenance Window. T2S does not perform any settlement services outside the night-time and day-time settlement periods.

The change of the T2S settlement date defines the start of a new Settlement Day. Following the change of the Settlement Date:

- T2S validates settlement instructions against Common Static Data valid as of the new settlement date and resulting from validated changes to the Common Static Data ; and
- T2S settles instructions on the new settlement date.

The following is an overview of the Settlement Day. A detailed description including time lines can be found in the T2S Manual of Operational Procedures (MOP):

- The Settlement Day begins with a start-of-day (“SOD”) period, starting after the change of the settlement date and ending prior to the start of night-time settlement. It includes processes that are critical for the smooth preparation of the night-time settlement procedures, such as the identification and revalidation of eligible instructions and changes to the Common Static Data valid as from or as for this settlement date. During this period liquidity transfers from RTGS systems will be accepted.
- The following night-time settlement period starts after the end of the “SOD” period and ends prior to the Maintenance Window. During the night-time settlement period mainly settlement instructions that were input on previous Settlement Days with an Intended Settlement Date that corresponds to the current settlement date are processed. The night-time settlement period consists of two settlement cycles.
- After the night-time settlement period the T2S schedule includes a technical window for system maintenance.

---

<sup>12</sup> Additional detail and further rules regarding the T2S calendar can be found in the Manual of Operating Procedures (MOP)

**Schedule 5 – T2S Service Description**

---

- After the end of the Maintenance Window T2S starts the day-time settlement period, which is used mainly for T+0 (same-day or intraday) settlement. In addition, it is during this period that failures from night-time settlement can be resolved.
- Before the End-of-Day (EOD) period starts, T2S operates different cut-off times for DvP, FoP, Central Bank operations<sup>13</sup>.

The EOD period of T2S starts after the end of the day-time processing and finishes prior to the change of the settlement date, permitting CSDs and their participants to perform critical end-of-day activities, such as fulfilling reporting requirements. From the start of the end-of-day procedure, securities and cash positions are stationary (with the exception of EOD procedures related to the auto-collateralisation as described above) since no settlement can occur until the start of the next Settlement Day's night-time settlement period.

**9.2. T2S SD.SUP 020: Operational monitoring services**

The T2S Operator monitors the T2S infrastructure and the T2S business application continuously:

- The T2S Operator observes the behaviour of the T2S production environment. If deviations from the normal Settlement Day are detected (the normal Settlement Day being defined as the behaviour of T2S over a defined time period):
  - within defined boundaries, the T2S Operator can trigger the appropriate corrective actions, when required, and
  - if necessary, the T2S Operator raises the alarms and indicates the appropriate level of priority as quickly as possible;
- In the event of operational issues the T2S Operator cannot resolve, the T2S Operator reports aggregated, up-to-date monitoring information.
  - In crisis and contingency situations, the T2S Operator provides up-to-date and comprehensive information to the crisis manager.
  - In the event of an incident or problem, the T2S Operator provides and tracks information about the status and logs its history, as well as documenting the analysis and solution.

---

<sup>13</sup> See further details in the SLA and in the MOP

**Schedule 5 – T2S Service Description**

---

- The T2S Operator reports his activities to assist in the Service Performance Indicators reporting required for Service Information and monthly Service Level Agreement reporting.

**9.3. T2S SD.SUP 030: Business continuity management services**

Business continuity in T2S is understood to mean managing single component failures as well as failures of a single site without losing data. The Business Continuity Management service ensures that the required IT technical and services facilities (including computer systems, networks, applications, telecommunications, technical support and Service Desk) can be recovered within required, and agreed, business time-scales.

The technical environment for the T2S data centre and application follows the “two regions / four sites” architecture. Inside a region, the distance between the two sites is more than 10 kilometres. System and application software are kept updated in parallel at the four sites and each of the four T2S sites satisfies the agreed Service Levels.

Different mechanism and procedures are implemented to guarantee business continuity:

- Single component failure
  - Hardware/Software and telecommunication components redundancy
  - software quality control and test execution
  - operational procedures (e.g. Change and Release Management)
- Site failure
  - Data in the two local sites are mirrored synchronous
  - Local recovery procedure to restart on alternate site

**9.4. T2S SD.SUP 040: Disaster recovery and crisis management services**

Disaster recovery services in T2S are understood to mean ensuring the resumption of T2S Services which were discontinued due to a high-impact disruption of normal business operations affecting a large metropolitan or geographic area and the adjacent communities that are economically integrated with it. In addition to impeding the normal operation of financial industry participants and other commercial organisations, major operational disruptions typically affect the physical infrastructure.

Disasters are events which are unforeseeable, unavoidable and beyond the reasonable control of the T2S Actor affected by the event and which has not been foreseen (“Force Majeure”).

Disaster recovery services ensure that the T2S Services can be recovered in an alternate region within the times defined in the Service Level Agreement. The T2S Business Application is

**Schedule 5 – T2S Service Description**

---

installed in two separate regions and the data in the two regions are mirrored in asynchronous mode. Regional disaster recovery procedures are defined to restart the solution and the applications in the alternate region. Additionally, T2S uses a “periodical rotation” procedure to ensure that all staff are properly trained and both regions are capable of hosting the T2S Services. T2S has defined a crisis management process to coordinate all activities in crisis situations. The crisis management process guarantees effective coordination of activities within all the involved organisations and appropriate communication, i.e. early warning and clear instructions to all concerned, if a crisis occurs.

**9.5. T2S SD.SUP 050: Archiving services**

T2S provides a central archive for its own purposes covering a 10-year period. The T2S central archive includes T2S static and transactional data.

T2S archives immediately all incoming and outgoing messages and files in their original format. After three months, T2S archives all instructions (settlement instruction, cash movements) as well as Common Static Data, billing and audit data.

In order to ensure the integrity of static and transactional data, Common Static Data revisions and Common Static Data history remain in the operational databases until the archiving procedures moves the transactional data that reference it into the archiving database.

CSDs, Central Banks and T2S Operators have direct access to archived data via A2A or U2A interfaces. Provided it is duly authorised by its Central Bank, a DCA holder has direct access to archived data of relevance to it. Other T2S parties have to request their Central Banks to retrieve and provide archived data to them.

**9.6. T2S SD.SUP 060: T2S service desk services**

T2S service desk provides a single, central point of contact for the CSDs, Central Banks, DCPs (if so authorised by their CSD), or DCA holders (if so authorised by their NCB) for handling all incidents, queries and requests related to business, functional or technical issues related to T2S. The T2S service desk is accessible 24 hours a day on T2S operating days. The Service Levels differ depending on the time of day.

On the basis of the complexity level of the service request/ enquiry, the T2S service desk guarantees different response times, in accordance with the response time matrix as published in the Service Level Agreement. Service Levels are measured against this matrix. All enquiries are recorded, and confirmations are provided to CSDs, Central Banks or DCPs (if duly authorised by their CSDs) when service requests are received.

T2S has ITIL-based problem and incident management processes in place:



**Schedule 5 – T2S Service Description**

---

- Incident Management - Incident Management captures the details of all incidents reported, implements temporary work-arounds and manages the resolution of incidents. Its goal is to restore normal service operation with minimum disruption to the business.
- Problem Management - The goal of Problem Management is to minimize the adverse impact of incidents and “known errors” on the business. The main focus of Problem Management is to identify the root cause(s) of incidents and to eliminate these if this is possible. While problems are being resolved Problem Management may produce temporary ‘work-arounds.’

An incident is defined as an event which is not part of the standard operation of the T2S Service and which cause, or may cause, an interruption or a reduction of the quality of that service. Incidents must be resolved immediately and are not part of the Change and Release Management. A problem is defined as an abnormal state or condition at the component, equipment, or sub-system level, which may lead to a failure in T2S that produces incorrect or unexpected results, showing a discrepancy between the relevant specifications and the actual results. Based on reported and acknowledged problems, and their criticality, T2S and the CSDs agree how to resolve them. A problem can result in a Change Request.

**9.7. T2S SD.SUP 070: Service Level management services**

T2S uses a Service Level Management process to maintain and improve service quality through a constant cycle of agreeing, monitoring and reporting of service achievements and instigating actions to correct non-adequate service delivery.

T2S provides reports on actual Service Levels achieved on a monthly basis. For each service indicator as defined in the Service Level Agreement, the performance achieved is compared with the target values. These reports are provided in accordance with the rules laid down in the Service Level Agreement.

**9.8. T2S SD.SUP 080: Invoicing services**

Invoicing services in T2S consist of:

- Automatically calculated invoices that are set up on a regular basis
- On demand: Ad hoc invoicing in special cases (for CSDs / Central Banks and / or customers of CSDs / Central Banks)

For both types of invoices, i.e. T2S invoice to CSDs and CSD invoicing support, the Invoice cannot be amended or adapted. Only

- approval
- cancellation and

**Schedule 5 – T2S Service Description**

---

- (re-) generation

are defined actions.

If a T2S Actor needs to receive a prior invoice (again), it can do so via a query in both A2A and in U2A mode.

**9.8.1. T2S SD.SUP 081: T2S invoicing to CSDs and Central Banks service component**

T2S automatically calculates invoices based on fees in accordance with the current T2S Tariff Structure and Price List. T2S invoicing reflects changes in the T2S Tariff Structure and Price List, which may be implemented at any time, but become effective only at the beginning of a billing period.

The invoice is calculated at the beginning of each calendar month for the past calendar month. All prices are calculated in Euro and VAT regimes in the different countries are taken into account, in case VAT needs to be included. Invoices and the underlying information are archived. CSDs and Central Banks receive a summary invoice, showing aggregate data for each billing item.

The prices for instructions are always charged to the CSDs of the two counterparties involved in a settlement instruction. Each Security Account and DCA needs to be assigned unambiguously to one CSD or Central Bank for the billing of the fixed fees.

Invoices are sent out once via push mechanism to the technical address which is defined in the Common Static Data. The invoice can also be queried using the GUI. As an additional service, ad hoc billing is possible in special cases.

Changes in the Pricing scheme may be implemented at any time, but become effective only at the beginning of the next billing period.

**9.8.2. T2S SD.SUP 082: CSDs / Central Banks invoicing support service component**

T2S supports the CSDs/ Central Banks by enabling them to invoice their clients in accordance with their individual tariff structures. To that end, as part of the T2S information services, a CSD/ Central Bank may query any of its assigned accounts, but no others.

T2S provides counters for all settlement process steps and instances as enumerated and described in the T2S data model. As part of the CSD/ Central Bank invoicing support service, each CSD/ Central Bank is able to query this level of data for each of its customer accounts.

T2S transmits details to the CSD/ Central Bank via a report based on an event at the end of the invoicing period. The CSD/ Central Bank invoicing support report provides additional information on billable items at the level of each customer account as an itemised list. This is

**Schedule 5 – T2S Service Description**

---

either sent in push mode or made available for pull mode.

Furthermore, on a monthly basis T2S provides a standard report containing all detailed transactional data and counters for each CSD/ Central Bank which is available only to the respective CSD/ Central Bank in pull mode. Each CSD / Central Bank receives only the data related to its and its DCPs interactions with T2S, i.e. the invoicing support report is CSD-/ Central Bank - specific and does not contain any data or information concerning any other CSD/ Central Bank.

**9.9. T2S SD.SUP 090: Change and Release Management services**

T2S is an evolving application, increasing and improving services by following a defined Change and Release Management process. Any T2S Actor who identifies a need to change T2S, may request new or amended features and/or functionalities following the agreed Change and Release Management procedure, specified in Schedule 9 (Change and Release Management) to the Framework Agreement and the Currency Participation Agreement. If there are inconsistencies between the description in this section and the provisions of Schedule 9 (Change and Release Management), the latter shall prevail.

CSDs may change parameters/configuration (i.e. rules for CSD validation hold/reject and the CoSD functionality) or reference data (i.e. ISIN, Security Account) without launching the Change and Release Management, although these actions may be subject to operational procedures, in particular if there is an impact on any other T2S Actors.

T2S uses ITIL based processes for Change and Release Management: These services encompass all stages of the Change Lifecycle from initiation and recording, through filtering, assessment, categorization, authorisation, scheduling, building, testing, implementation and ultimately their review and closure.

The Eurosystem has established a Change Review Group (CRG) to evaluate the information provided in the Change Request and in the preliminary assessment (especially checking its consistency and completeness across all Change Requests) and to prepare for the change authorisation or rejection decision. The CRG is responsible for building and maintaining the scoring mechanism as a tool for facilitating the definition of the content of each T2S release and making proposals for, reviewing and monitoring the content of T2S releases as well as any changes to any agreed release.

**9.9.1. T2S SD.SUP 091: Change Management service component**

Changes in T2S, which are subject to the Change and Release Management, are defined as changes on T2S functionality and/or to the Scope Defining Set of Documents. Changes may arise for a number of reasons:

**Schedule 5 – T2S Service Description**

---

- Innovation and improvement – the introduction of new services/ technical capability
- New functionality to meet business needs of T2S Parties
- Changes in law or in regulatory (including fiscal) requirements
- Clarifications/corrections to functional and/or technical documentation/gaps in line with the user requirements

T2S distinguishes between the following types of changes:

- according to beneficiary:

- Common Changes include new features, functionalities or services which are implemented for the benefit of – and available without restrictions to – all T2S Actors. They have an impact on all T2S Actors and the costs are shared by all T2S Actors.
- Specific Changes are any new feature, functionality or services which is not implemented as a Common Change, but which some CSDs/CBs wish to implement, and to which the other CSDs/CBs do not object. The costs of these changes are shared only by the entities using the feature, functionality or service, which is changed. The functionality is used only by the supporting parties but is made available to all T2S Actors.

- according to urgency:

- Normal changes are changes that can be planned and go through the whole Change and Release Management before being implemented into the live environment.
- Fast-track Changes are changes that are imposed by Legal and Regulatory Requirements, or by CSG resolutions related to risk management requirements, or changes that are critical for the stability of the T2S Platform or by Central Bank decisions related to safeguarding the currency/-ies or related to crisis management measures to ensure financial stability and that, owing to the time constraints, have to be implemented in a shorter timeframe than normal, which will be decided on an ad-hoc basis, as specified in Schedule 9. These changes will also go through the normal CRM process, however, the length of the different process steps will be shortened on an ad-hoc basis, in particular for preliminary and detailed assessment.

Each change will be categorised based on the following parameters:

- Legal/Business importance
- Market implementation efforts
- Operational/technical impact
- Financial impact for T2S

Every initiated Change Request is identified via a Change Request identifier. All Change

**Schedule 5 – T2S Service Description**

---

Requests are published and made available to all duly authorised T2S Actors in accordance with the agreed Governance arrangements and the agreed Change and Release Management procedure, specified in Schedule 9 (Change and Release Management) to the Framework Agreement and the Currency Participation Agreement.

In certain cases an incident may result in an urgent intervention on T2S aiming to ensure a quick restoration of T2S Services. On account of its urgency, such a intervention cannot be processed via the normal Change and Release Management. These Fast-track Changes are therefore processed via faster operational procedures as defined and further detailed in the Manual of Operational Procedures (MOP).

**9.9.2. T2S SD.SUP 092: Release Management service component**

Once the changes have been duly authorised for implementation, they are bundled and assigned to future T2S releases. The term “Release” is used to describe a collection of authorised Change Requests which consist of enhancements to the T2S Service and/or a number of bug fixes which are implemented into the production environment. A scoring mechanism is applied to identify all authorised changes and bug fixes for a specific release. The Release Management services include the planning, design, build, configuration and testing of T2S software and hardware needed for the implementation of the changes to create a set of release components.

The Release Management services ensure that all aspects of a change, technical and non-technical, are considered together. The main objective is to deliver, distribute and track one or more changes intended for simultaneous release into T2S operations while protecting the integrity of the T2S production environment and its services. Release Management services ensure that authorised changes and bug fixes that have been agreed as part of a release are secure and traceable, and that only correct, tested and authorised versions are installed into the production environment. Furthermore, through Release Management any amended legal or contractual obligations T2S has to comply with will be implemented.

Before implementing any release, T2S performs T2S-internal acceptance tests to verify that the system operates as predicted and fulfils the requirement and the functional specification of the Change Request.

Once T2S-internal acceptance test is finalised, T2S provides the CSDs and Central Banks with the test results and confirms the readiness of the T2S testing environments for the T2S User Testing. The test calendar is agreed with the CSDs and Central Banks, and information is provided on the testing activities, and regarding the availability of the testing environments.

The release is verified in accordance with the Governance arrangements, with the involvement of the CSDs and Central Banks once the exit criteria of the verification process have been completed successfully.

The delivery of the application software release into the production environment is the final step

**Schedule 5 – T2S Service Description**

---

in the Release Management.

T2S provides and updates T2S User Documentation as part of the Release Management.

**9.10. T2S SD.SUP 100: Test and training services****9.10.1. T2S SD.SUP 101: Testing service component**

The objectives of the T2S User Testing are:

- to ensure that T2S fully meets user requirements as expressed in the Change Requests of the relevant release, as well as the functional and non-functional specifications agreed by T2S,
- to guarantee the readiness of the CSDs, Central Banks and its DCPs to operate in accordance with the agreed release.

T2S provides diverse testing environments for T2S Actor testing activities:

- one for the CSD/ Central Bank wanting to test changes in their own applications against the current T2S operating environment,
- other(s) for the CSD/ Central Bank to test future T2S releases.

The T2S testing environments are sized and prepared for interconnection with the testing environments of the T2S Actors via test networks. T2S reserves the right to block one environment for its own regression testing of new releases.

The security levels of the testing environments are the same as for the T2S production environment. The testing environments have a substantially lower technical capacity compared to the production environment. This capacity can be increased to cover specific testing needs (e.g. high-volume tests during the Community testing and the Business Day testing stages). During the T2S User Testing execution phase, the T2S operating procedures reflect as much as possible those that are agreed for live operations.

T2S testing environments use the same problem and incident processes as the operating environment.

**9.10.2. T2S SD.SUP 102: Training service component**

T2S delivers training services to the CSDs, Central Banks and DCPs based on the “train the trainer”-concept. The exhaustive and self-explanatory T2S training documentation shall facilitate in-house training at CSDs, Central Banks and at their participants. The scope of T2S training sessions covers aspects of the day-to-day activities of technical, functional and operational nature as well as one-off activities for the testing of and migration to T2S.

T2S provide the CSDs and the Central Banks with the T2S Training Framework, on the basis of

## Schedule 5 – T2S Service Description

---

which T2S defines and elaborates the T2S Training Packages. Depending on the training delivery strategy and mode selected (inherent in the T2S Training Framework), T2S guides, delivers and provides support for the T2S training for the CSDs and for the Central Banks.

The T2S Training Framework is elaborated and rolled out so that a timely and efficient knowledge transfer to the end-users of T2S can be accomplished. The T2S Training Framework further clarifies and details all organisational and planning aspects related to the training.

# CURRENCY PARTICIPATION AGREEMENT

## SCHEDULE 6

### T2S SERVICE LEVEL AGREEMENT

22 September 2022



### Table of contents

1.	<b>Introduction</b> .....	4
2.	<b>Parties, commencement date and scope</b> .....	5
2.1	Identification of the Parties .....	5
2.2	Scope .....	5
2.3	Commencement date .....	5
3.	<b>Service responsibilities</b> .....	6
3.1	Eurosystem’s responsibilities .....	6
3.2	Responsibilities of the [NCB] .....	8
3.3	Operational Procedures .....	10
4.	<b>Service Levels in the production environment</b> .....	12
4.1	Definitions of Service Level indicators .....	12
4.1.1	Service availability .....	12
4.1.1.1	Availability Period .....	12
4.1.1.2	Availability .....	13
4.1.1.3	Punctuality and Substantial delay .....	14
4.1.1.4	System performance .....	16
4.1.1.5	Business Validation Time .....	17
4.1.1.6	Matching time .....	17
4.1.1.7	Real-time Settlement time .....	17
4.1.1.8	Static data processing time .....	18
4.1.2	Response times .....	19
4.1.2.1	A2A Query Response Time .....	21
4.1.2.2	A2A Message Response Time .....	21
4.1.2.3	A2A response time for messages bundled in files .....	21
4.1.2.4	U2A Response Time .....	22
4.1.2.5	Online Storage Period .....	23
4.1.2.6	Archiving Period .....	23
4.1.2.7	Archive Retrieval Response Time .....	24
4.1.3	Support Hours and Incident Response Times .....	24
4.1.3.1	T2S Settlement Day .....	<b>Error!</b>
	<b>Bookmark not defined.</b>	
4.1.3.2	Support Hours .....	27
4.1.3.3	Incident Response Time .....	27
4.1.3.4	Incident Resolution Time .....	27
4.1.4	Business Continuity and Disaster Recovery .....	28
4.1.4.1	Recovery time .....	29
4.1.4.2	Recovery Point Objective .....	30

# Currency Participation Agreement

## Schedule 6 – T2S Service Level Agreement

ECB-PUBLIC

---

4.2	Committed Service Levels for the production environment.....	30
4.2.1	Operational and support services.....	30
4.2.2	Settlement services and liquidity management services.....	33
4.2.3	Static Data services.....	34
4.2.4	Information services.....	35
4.2.5	Connectivity services.....	36
4.3	Targeted Service Levels for the production environment.....	36
4.3.1	Information services.....	36
5.	<b>Service Levels for the test environments</b> .....	37
5.1	Service Levels for the Pre-Production environment.....	37
5.1.1	Operational and support services.....	37
5.2	Service Levels for the Interoperability test environment.....	38
5.2.1	Operational and support services.....	38
5.2.2	Availability.....	38
5.3	Additional provisions.....	39
6.	<b>System capacity and platform sizing</b> .....	41
7.	<b>Service Level reporting</b> .....	42
7.1	Content of the Reporting.....	42
7.2	Definition of Additional Indicators for Reporting.....	43
7.2.1	File throughput.....	43
7.2.2	Batch Settlement throughput.....	43
7.3	T2S Operations report.....	44
8.	<b>Monthly Service review meetings</b> .....	45
9.	<b>Annual SLA reviews</b> .....	46
	<b>Annex 1 - Management of non-functional changes</b> .....	47
1.	Emergency Changes.....	47
2.	Other changes.....	47

### 1. Introduction

This Service Level Agreement (SLA) documents the commitments of the Parties to each other, in particular the service levels under which the Eurosystem will provide the T2S Services to the Connected Central Banks (and vice versa), which have entered into the Currency Participation Agreement with the Eurosystem. The main objective of this document is to describe the Service Levels agreed between the Parties and to define the Key Performance Indicators (KPIs) used to measure these Service Levels.

This SLA assigns responsibilities to and describes interactions between the Parties. This SLA defines the agreed service levels for the provided services. The legal rights and obligations between the Parties that apply when the service level is not reached are specified in the provisions laid down in the Currency Participation Agreement.

This SLA is part of the legal arrangements between the Eurosystem and non-euro area Central Banks, under the Currency Participation Agreement. Unless explicitly mentioned this SLA is the same as the one concluded with all other Connected NCBs. It is the intention of the Parties to reach the highest possible level of harmonisation between all SLAs. The commitments of the Eurosystem and the Connected NCBs set out in chapters 2, 3, 4, 7 and 8 will not be altered without mutual agreement. The commitments in chapters 5 and 6 will be subject to the amendment process defined in the CPA.

Annex 1 (Management of non-functional changes) to this document covers the process to manage non-functional changes needed to maintain the agreed Service Levels, or to increase them as a result of the SLA review process.

## 2. Parties, commencement date and scope

### 2.1 Identification of the Parties

The Parties to this Service Level Agreement are the Eurosystem and the [NCB].

The Directly Connected Parties (DCPs) do not have a direct legal relationship with the Eurosystem for the use of T2S Services. Nevertheless, they will obtain certain rights and be subject to certain obligations from this SLA through the mandatory inclusion of certain provisions in their legal arrangements with their [NCB]. These provisions are explicitly reflected in section **Error! Reference source not found.** of this SLA.

### 2.2 Scope

This SLA refers to the T2S Production environment and its accompanying test environments. It covers the full range of services as described in Schedule 5 for each of the service classes, i.e. Settlement Services, Liquidity Management Services, Static Data Management Services, Information Services, Connectivity Services, and Operational and Support Services. In addition, this SLA covers the relevant service commitments from the Eurosystem with respect to the support of the User Testing activities as specified in Schedule 3 (User Testing).

### 2.3 Commencement date

This SLA shall enter into force as from the day the [NCB] starts its User Testing activities on the T2S Platform. More specifically, as from that day until the [NCB] Migration, the provisions with respect to the T2S test environments as specified in chapter 5 will apply.

### 3. Service responsibilities

#### 3.1 Eurosystem's responsibilities

The Eurosystem must:

- a) establish the T2S service desk as a Single Point of Contact (SPOC) for the [NCB] (for technical and operational problems) and provide the contact details (e-mail, mobile phone, telephone);
- b) support the [NCB] in the operational management of its technical connection and that of its DCA holders if needed;
- c) ensure the permanent reachability of a ECB Crisis manager, T2S Operator's Crisis manager, T2S Service manager and T2S co-ordinator and provide their contact details (e-mail, telephone);
- d) be able to extend the cut-off time for cash transfers in the currency provided by and at the request of the [NCB], in accordance with the provisions of the MOP;
- e) refrain from scheduling system downtimes without pre-advice and green light of the Connected NCBs outside the Maintenance Windows;
- f) announce planned non-functional changes according to the provisions specified in Annex 1 to this Schedule;
- g) provide on-line access to information to allow the [NCB] to track and follow up all incidents, problems and release defects related to or impacting the [NCB];
- h) provide a monthly Service Level Report to the Contracting [NCB] according to the provisions in section 7 of this SLA;
- i) manage the impact on the [NCB] and the T2S Service as a whole caused by any party making unusual demands on capacity by:
  - a. contacting the user without delay if the latter misbehaves, misuse T2S or consumes system resources in any other way to an extent that exceeds the forecasted capacity and might prevent the Eurosystem from delivering the agreed service to other users;
  - b. denying (up to and including temporary disconnection) access to a user, if i) threatening the stability of the platform impacting other users and ii) not responding effectively to the Eurosystem's request to prevent further misbehaviour;
- j) deny the service by disconnecting any user that did not respond effectively to a request from the Eurosystem to prevent the recurrence of previous misbehaviour and that continues to threaten the stability of the platform with impact on other users until the user has demonstrated that the threat no longer exists;
- k) ensure an adequate long-term planning for capacities corresponding to the requirements laid down in section 7 of this SLA;

# Currency Participation Agreement

## Schedule 6 – T2S Service Level Agreement

ECB-PUBLIC

- l) inform the [NCB] if technical problems with one of its T2S Dedicated Cash Account Holders are detected that might have an impact on the [NCB] as well;
- m) maintain documentation pertaining to Crisis management and provide it to the [NCB] on request or after any change;
- n) support the [NCB] in business continuity testing if required (subject to prior agreement).

During normal operation the T2S co-ordinator (appointed by the Eurosystem), the T2S Service manager (appointed by the T2S Operator), the CB settlement managers (appointed by each Central Bank), will apply the procedures specified in the Manual of Operational Procedures (see also section 3.3). In addition, the Eurosystem stands ready to provide through the T2S service desk

- information on technical and operational issues, in particular the running of T2S;
- information on T2S functionality;
- up-to-date information concerning the running of T2S, if need be.

If a Crisis Situation, as described in art. 23.1 of the Currency Participation Agreement, arises within the domain of the Eurosystem, the latter will inform the [NCB] according to the agreed response times.

In addition, the following provisions will apply in such case:

- The Eurosystem will take all necessary actions to restore the T2S Service according to the agreed business continuity procedures. These procedures are based on the following key principles:
  - Any settlement in T2S before the incident will continue to have the legal effect specified in art. 20.1 of the Currency Participation Agreement.
  - If a data loss materialised, the recovery will be done together with the [NCB] by procedural means.
- As soon as the Eurosystem identifies the need to switch to the other site in the same region, or to fail-over to the standby region, the T2S co-ordinator initiates a teleconference to inform the settlement manager of the [NCB] about the nature of the event triggering the failure, the nature of the failure and the envisaged plan to recover from the failure.
- The Eurosystem will keep the settlement manager of the [NCB] informed about the progress of the failover activities, and in particular when T2S is available again for normal operations.

- The Eurosystem may decide to gradually re-open T2S, in which case it will seek the approval of the [NCB].
- In case T2S cannot be restarted without a potential data gap, the Eurosystem will first re-open T2S for the purpose of reconciliation only and will co-ordinate these reconciliation activities.
- During this reconciliation phase, the [NCB] is responsible to verify the status of its T2S records, and to re-send instructions with the aim to bring the T2S records consistent with its internal records. This includes also changes to the T2S records that happened as a result of an interaction with a DCA holder belonging to the [NCB]. It is up to the [NCB] to agree with its DCA holders how this is organised.
- The Eurosystem and the [NCB] will co-operate in good faith and will - if necessary - agree on additional measures with the aim to close the data gap.
- The Eurosystem will seek the agreement of the Crisis Managers of the Central Banks and the Crisis Managers of the CSDs to re-open T2S for normal operations.
- The Eurosystem will provide any service described for normal operations but balancing this with the need to restore the service.
- The Eurosystem will provide reports on unresolved incidents.

Detailed procedures for incident priority setting and incident handling will be specified in the Manual of Operational Procedures (MOP).

### 3.2 Responsibilities of the [NCB]

The following responsibilities are accepted by the [NCB] in order to allow the Eurosystem to meet the agreed Service Levels.

The [NCB] must:

- a) appoint and ensure the permanent reachability of a settlement manager and a Crisis manager as contacts for the Eurosystem and provide their contact details<sup>1</sup> (e-mail, telephone, mobile phone);

---

<sup>1</sup> At the Connected NCB's discretion, the Settlement Manager and the Crisis Manager can be the same person.

# Currency Participation Agreement

## Schedule 6 – T2S Service Level Agreement

ECB-PUBLIC

---

- b) provide contact details for technical staff that is capable of resolving technical issues with their (directly connected) Dedicated Cash Account Holders (e.g. staff belonging to the DCA Holders' organisation);
- c) inform the relevant DCA Holders
  1. before requesting the Eurosystem to extend the cut-off time for cash transfer in the currency provided by the [NCB],
  2. before preventing additional cash to be transferred to the Dedicated Cash Accounts, and
  3. before draining a significant amount of cash from the Dedicated Cash Accounts back to the RTGS system;
- d) have a local service desk acting as a single point of contact for all its Dedicated Cash Account Holders during normal business hours;
- e) proactively report any problem or incident relating to T2S including connectivity problems, provide all information that might be helpful and cooperate where requested by taking all appropriate actions for solving the problem or incident;
- f) report such problems or incidents to the T2S service desk within a reasonable time;
- g) provide timely information on any changes that may affect the [NCB]'s ability to interact with T2S as expected;
- h) ensure an appropriate use of T2S and that the personnel who works on T2S and its own systems and equipment is accordingly qualified and suitably trained;
- i) ensure availability of skilled staff within a pre-agreed time period in order for the Eurosystem to obtain support in handling incidents and/or reducing their impact on the service;
- j) be able to resend – at the request of the Eurosystem - all messages already sent after a specified recovery point during the same Settlement Day (approx. two minutes - in particular in case of disaster recovery scenarios with possible data loss);
- k) keep all access rights it has registered for access in T2S consistent with all relevant -user information;
- l) provide all DCA holders with all information to facilitate their smooth functioning in T2S;
- m) ensure the operational management of its own organisation as well as their customers including DCA holders;
- n) use reasonable efforts to ensure its connectivity with T2S and require the same of its DCA holders, as far as applicable according to Article 30;
- o) take part in the test process for new releases in the test environment;
- p) co-operate with the Eurosystem by promptly reporting any difficulties however small following each release into the production environment;



q) support the Eurosystem in business continuity testing if required.

### 3.3 Operational Procedures

The Manual of Operational Procedures (MOP) will provide a reference guide for the operational procedures (in normal and abnormal situations) which the Directly Connected T2S Actors (including the [NCB]) and the Eurosystem should follow to ensure a smooth functioning of T2S. It will contain all the information required for the addressees to carry out all their tasks in normal and abnormal situations.

The day-to-day operational management of T2S will be handled at two levels. First, the T2S co-ordinator, the T2S service manager, the CSDs Settlement Managers and the Central Banks Settlement Managers (jointly called “Settlement Managers”) will jointly perform the tasks and apply the procedures as specified in the MOP. Second, the ECB Crisis Manager, the T2S Operator Crisis Manager, the CSDs Crisis Managers and the Central Banks Crisis Managers (jointly called “the Crisis managers”) will make the decisions allocated to them in the MOP, and will take over the management of T2S in situations that are not covered in the MOP. The Crisis managers will be assisted and advised by the settlement managers in that case.

The latter includes the Business Continuity and Disaster Recovery arrangements, i.e. the set of rules and procedures aimed at resuming the normal T2S Services after the occurrence of an incident, as well as at mitigating the impact of such incident.

The key principles for the incident management can be summarised as follows:

- If the [NCB] detects an incident that is related to or might have an impact on the T2S Services, it will inform the Eurosystem without undue delay.
- If the Eurosystem detects an incident, it will be communicated to the [NCB], if a direct or indirect impact is possible.
- If an incident is reported by a DCA holder of the [NCB], the Eurosystem will inform the latter without undue delay, and keep the [NCB] informed about the resolution path of such incident. Any action to escalate such incident, will be undertaken in close co-operation with the [NCB].

Both sides will co-operate to reduce the impact of an incident.

As far as the incident management procedures defined in the MOP allow to handle a particular incident, the T2S coordinator (appointed by the Eurosystem), the T2S service manager (appointed by the T2S Operator), the Settlement Managers (appointed by each Central Bank and by each CSD

respectively) will co-operate in good faith and exchange all relevant information that is necessary to handle the incident as specified in the MOP.

When the incident cannot be handled within the procedures specified in the MOP, the ECB Crisis manager, the T2S Operator Crisis Manager (appointed by the T2S Operator), the CSDs Crisis Managers (appointed by each CSD) and the Central Banks Crisis managers (appointed by each Central Bank) will decide – in accordance with the applicable governance arrangements – which measures will be taken to mitigate the impact of the incident and to resume normal operations.

Both sides will co-operate in analysing the root-cause for an incident.

Both sides will co-operate in analysing the management of the incident and updating the MOP should it be found lacking in any way.

The Eurosystem will report on the results of the root-cause analysis. An initial report with the impact analysis will be provided within two Settlement Days. An interim report, which is optional, will be provided only upon OMG request, and a final report within ten Settlement Days.

Whether or not a request to change a cut-off time, either from the Eurosystem or from the [NCB], is related to an incident, the Eurosystem will involve the Settlement Managers and/or the Crisis Managers in making such decision, according to the procedures further specified in the MOP.

### 4. Service Levels in the production environment

This section describes the Key Performance Indicators (KPIs) agreed for the delivery of the service during **normal operations**. As a general principle, the Eurosystem has to ensure that sufficient efforts are made to fulfil all KPIs and must take remedial action as soon as it detects that a KPI may not be, or is not, fulfilled.

The [NCB] is committed to provide all reasonable support to the Eurosystem, in order to allow the latter to take such action.

T2S is a service shared between several users. All specified service levels are therefore multilateral service levels, i.e. they define the service provided to the community as a whole. Nevertheless, the service level reporting will contain the achieved bilateral service levels for the [NCB] in addition to the achieved multilateral service levels. For this bilateral reporting, the service levels reported for the [NCB] will include the service levels obtained by its DCA holders.

#### 4.1 Definitions of Service Level indicators

This chapter provides a common definition of the service level indicators. While Section 4.1.1 covers availability and punctuality, where Section 4.1.1.4 lists the response times and Section 4.1.3 covers support and recovery issues. The actual agreed levels are stated for each service individually in section 4.2 below.

##### 4.1.1 Service availability

###### Objective:

These indicators define the times during which the T2S Services are available in relation to the T2S Settlement Days.

###### 4.1.1.1 Availability Period

The Availability Period is the time period during the T2S Settlement Day when the service is stated as expected to be available to the [NCB]. The start and end time of the availability period is based on business events on the T2S Platform. Any times stated are indicative and could be altered in certain circumstances according to the Procedures specified in the Manual of Operational Procedures (e.g. delay of the end-of-day).

### 4.1.1.2 Availability

#### Definition:

A service is considered to be available when it responds and operates according to its definition in the Service Description and its functional description in the User Detailed Functional Specification (UDFS chapter 1).

#### Measurement:

The availability of the services is measured continuously and objectively at predefined components of T2S, throughout each Settlement Day with the exclusion of the Maintenance Window.

The measurement of downtime is based on auditable data collected either automatically or manually. Manual measurements will be used in situations where no automatic log entries are available (e.g. power failure).

Downtime is the time between the start of an incident that causes the unavailability of a service and the closing of the incident that caused the downtime, i.e. when the service has been restored. In case of multiple incidents at the same time the downtime begins with the start of the first incident and ends with the closing of the last incident.

#### Calculation:

$$a_i = \left(1 - \frac{d_i}{T_m}\right) \times 100$$

$$a = \sum_{i=1}^n a_i \times w_i$$

Where:

$a_i$  = availability of the service  $i$  as percentage

$d_i$  = cumulative downtime of the service  $i$  for the reporting period

$T_m$  = total planned up-time for the reporting period

$w_i$  = weight of the service  $i$

$a$  = weighted availability as percentage

The availability of a service is expressed as a percentage of the aggregated downtime in relation to the aggregated expected up-time during the reporting period. The calculation is based on minutes.

The weights of the service ( $w_i$ ) used in the KPI calculations will be documented in the T2S Manual of Operational Procedures (T2S MOP), as amended from time to time.

### 4.1.1.3 Punctuality and Substantial delay

Definition:

If (i) an event defined in the T2S daily schedule and included in the agreed subset of events or (ii) a T2S process<sup>2</sup> is likely to start or finish<sup>3</sup> later than the original scheduled/agreed time and has a potential impact on the [NCB], the Substantial delay defines for each event the maximum delay that will be tolerated by the [NCB]. Any delay or expected delay exceeding the substantial delay will be communicated to the [NCB] immediately.

Any delay not exceeding the substantial delay is not actively communicated to the [NCB] but is available for querying on the T2S Platform.

In addition, for some events and phases of the T2S daily schedule, a maximum duration is agreed upon, and any delays with the duration of those events and phases will have to be communicated to the [NCB] immediately.

Events delayed upon request of the Central Banks -or the Participating CSDs do not fall into the Substantial delay category – the agreed time span of the aforementioned delay(s) shall not be accounted for the computation of the phases or processes relevant for the KPI on duration.

Measurement:

The punctuality of T2S is measured by counting the number of occasions when:

- the start of the selected T2S business events are delayed for a time period exceeding the defined substantial delay (4.2.1);
- the end of the selected T2S business events is delayed for a time period exceeding the defined substantial delay (4.2.1);
- the duration of the predefined periods of the Settlement Day exceed the agreed values (4.2.1).

and is expressed as a percentage value encompassing the overall number of occurrences against the number of Settlement Days in the reporting period

---

<sup>2</sup> This applies to monthly Billing process only. It consists of calculation of charges for the consumption of T2S Services and the sending of the corresponding invoices to the CBs/CSDs.

<sup>3</sup> This applies to the Monthly Aggregated Amounts Report event (MAGG) and monthly Billing process only.

$$p = \left(1 - \frac{d_i}{o_i \times b_i}\right) \times 100$$

Where:

$p$ = punctuality of the service as percentage

$d$ = cumulative number of times where an event was delayed for the reporting period

$o$ = total number of predefined events occurring in the reporting period

$b$ = number of Settlement Days in the month

Measurement:

The delays in the start of an event will be checked using the planned and the actual start time stamps for the relevant events as logged by T2S.

The following events are relevant for this calculation:

- EUR Intraday Delivery versus Payment (DVP)<sup>4</sup> cut-off
- DKK Intraday Delivery versus Payment (DVP)<sup>5</sup> cut-off
- EUR Generate Outbound LT (GOLT)<sup>6</sup>
- DKK Generate Outbound LT (GOLT)
- Intraday Free of Payment (FOP) cut-off (IFOP)
- Change of the business day completed (BDCD)
- Start of Cycle 1 / Preparation of Sequence 0 (C1P0)
- Maintenance Window Completed (MTWC)

The delays in the end of an event will be checked using the committed end timestamp and the actual end timestamp for the relevant events as logged by T2S. The following events are relevant for this calculation:

- Monthly Aggregated Amounts Report event (MAGG)<sup>7</sup>

---

<sup>4</sup> Please see Currency Participation Agreement, Schedule 1 – Definitions.

<sup>5</sup> Please see Currency Participation Agreement, Schedule 1 – Definitions.

<sup>6</sup> Event GOLT for EUR currency will be decommissioned starting from the deployment of the R6.2 to production environment. From that moment onwards its delays will no longer be measured.

<sup>7</sup> The delay over the committed end time of the event (9:30 h) is only relevant on the Business Day of the month when the Monthly Reporting of the Penalty Mechanism takes place. Hence, it will be excluded from being expressed as a percentage value following the measurement defined for the rest of punctuality and delay indicators.

The following periods or processes of the Settlement Day are relevant for the calculation of the KPI on the duration:

- Start of Day: from the start of the event BDCD to the end of the event End of Start of Day (ESOD));
- Night Time Settlement: from the start of C1P0 until the end of the NTS reporting (Event ENTS);
- End of Day: from the Start of the End of Day (SEOD) until the End of Day Reports (EEOR);
- Start of the RTS after the MTNW;
- Duration of the IDVP cut-off;
- Penalty Mechanism daily processes: from the start of the event for the deadline for provision of penalty reference data (PMDD) to the end of the last event to close, i.e. event for reporting modified penalties (MDPL) or the event for reporting new daily penalties (DAPL).
- Monthly Billing process: the end of the process is marked by the provision of the T2S invoices on the first Settlement Day of the month to the CBs/CSDs.

#### 4.1.1.4 System performance

##### Objective:

These indicators define the system performance the [NCB] is expecting from the T2S Platform. T2S will be sized as a single shared environment on the basis of data supplied by the Participating CSDs (see chapter 6), with a margin for exceptional peaks (see 4.2.2).

If the volumes processed in production exceed the estimated T2S system capacity, i.e. ceilings (see chapter 6), service performance commitments are not binding for the Eurosystem. In such scenario the operational day shall not be affected, i.e. the T2S platform shall function without incident and without the potential need of actions from the [NCB].

In case the volumes exceed also the margin envisaged for the exceptional peaks (see 4.2.2), the service performance commitments are also not binding. In such scenario service performance breaches may occur and incident management procedures are applied with the potential need of actions from the [NCB] to resolve the incident.

### 4.1.1.5 Business Validation Time

#### Definition:

The Business Validation Time is the time that elapses between the reception of an instruction by T2S and the end of the business validation process, i.e. the time when T2S triggers the generation of the acceptance or rejection message.

#### Measurement:

The Business Validation Time is measured based on timestamps created by the T2S network interface and the timestamps stored as part of the audit trail in the T2S database. The settlement instructions and restrictions that are checked either against restriction types configurations with more than 10 market-specific attributes or a restriction type rule with more than 5 market-specific attributes, as well the instructions with linked settlement instructions and restrictions above 50 are excluded from the calculation.

This KPI does not apply during the EoD reporting phase<sup>8</sup>.

### 4.1.1.6 Matching time

#### Definition:

The Matching time is the time that elapses between the end of a successful business validation and the end of the first Matching attempt. The end of a Matching attempt is marked by the time T2S triggers the generation of the Matching status notification message or the detection that there is not yet a Matching instruction available.

#### Measurement:

The Matching time is measured based on timestamps stored as part of the audit trail in the T2S database..

### 4.1.1.7 Real-time Settlement time

#### Definition:

The Real-time Settlement time indicator covers the period between the end of the creation of the matching object (i.e. after successful matching) and the end of the first settlement attempt. The end

---

<sup>8</sup> The EOD reporting phase is marked by the start of event EESR and the closure of event EEOR.



of the settlement attempt is marked by the time T2S triggers the generation of the settlement status notification message.

The Real-time Settlement time indicator is relevant only for settlement instructions sent on the Intended Settlement Date after the start of the Real-time Settlement phase of T2S (marked by event STDN).

### Measurement:

The Real-time Settlement time is measured based on timestamps stored as part of the audit trail in the T2S database.

### Additional remarks:

For the T2S settlement process several cut-off times have been defined. The T2S Platform will ensure that each settlement instruction that has been sent and acknowledged before the relevant cut-off time will get at least one settlement attempt.

All Settlement Instructions using realignment, CoSD, resorting to auto-collateralisation or sent with business links (link with or pool) that exceed the agreed KPI as a result of the additional processes involved, will be mentioned separately in the SLA Report

### **4.1.1.8 Static data processing time**

#### Definition:

The static data processing time is the time that elapses between the end of a successful business validation and the end of the processing of this request.

This indicator is relevant only for all types of static data maintenance instructions.

#### Measurement:

The static data processing time is measured based on timestamps stored as part of the audit trail in the T2S database.

#### Additional remarks:

In Batch Settlement mode certain types of static data maintenance requests might be queued to ensure the consistency of the settlement processing. In these cases the processing is considered complete after the creation of a new revision for the relevant entities even though this revision is only activated at a later point in time.

### 4.1.2 Response times

Objective:

Time indicators provided in the following sections are always measured within the T2S perimeter under the responsibility of the Eurosystem as shown by the dashed line in the diagram below. The actual transmission time of the data via the network between T2S and the [NCB] is not included in the response time.

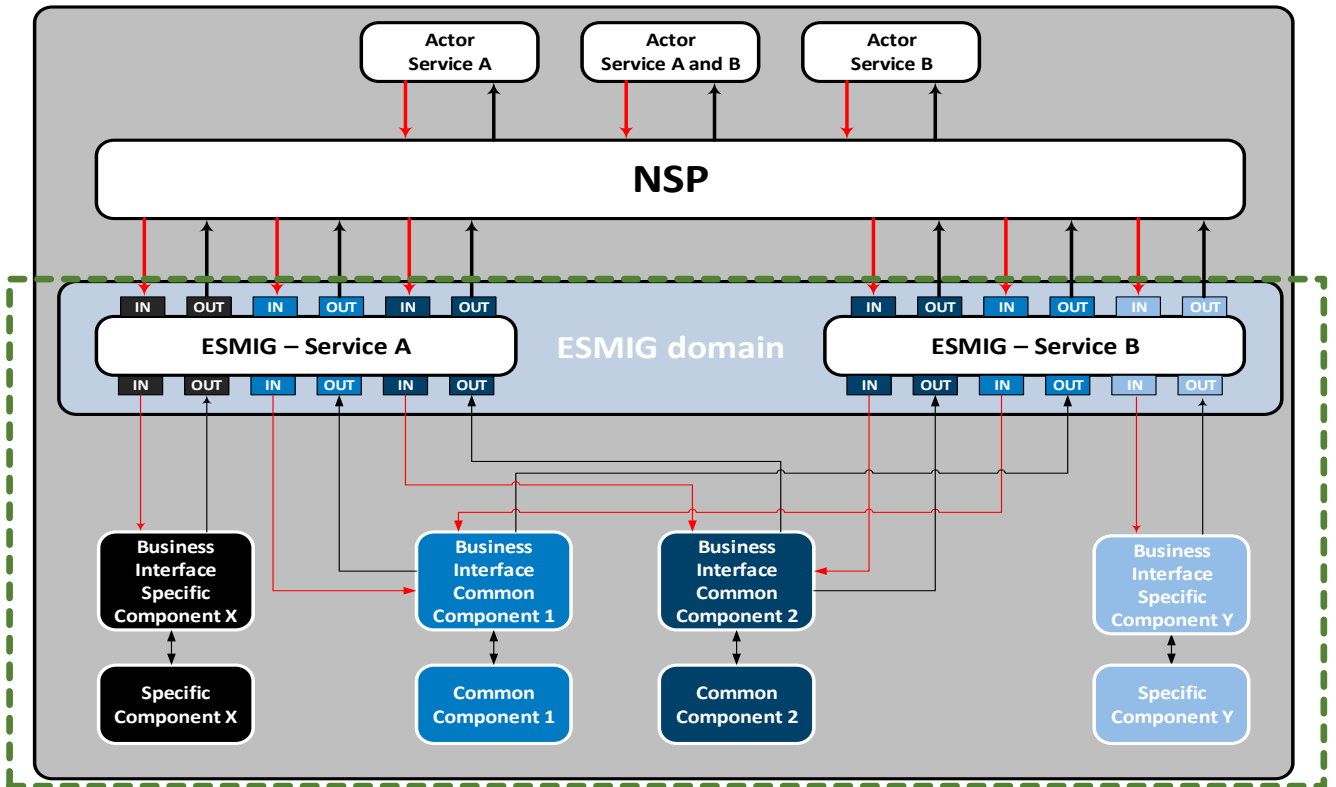

The response time indicators define the time period between the reception of a request and the corresponding response of the T2S Platform. All performance indicators are measured during each T2S Settlement Day during the time window when the information services are expected to be available.

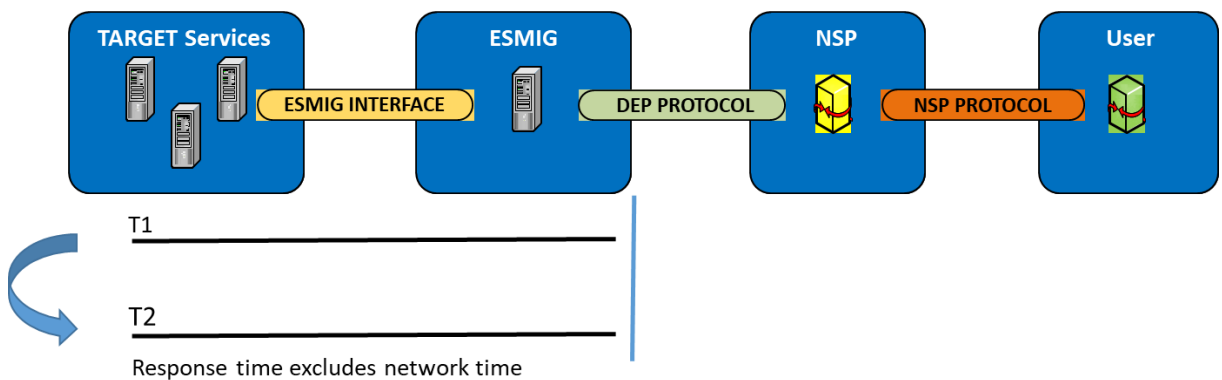

Additional remarks:

All messages that have been queued during the Maintenance Window and queries that have been queued during Batch Settlement will not be included in the calculation of the response times.

Simple Queries and Complex queries are those referenced as such within the User Detailed Functional Specifications (UDFS).

### 4.1.2.1 A2A Query Response Time

Definition:

For A2A query requests the response time is defined as the time elapsed between the reception of the query request message and the completion of the sending out of the corresponding result message (see diagram above).

Measurement:

The response times for A2A queries are measured using the timestamps generated by the T2S network interface.

The KPI does not apply for queries processed during throughput peaks exceeding 3 queries per second and to queries messages processed during the End of Day Reporting phase<sup>9</sup> where the system load is generally very high and several processes are running concurrently.

### 4.1.2.2 A2A Message Response Time

Definition:

For all A2A requests other than A2A Queries the response time is defined as the time elapsed between the reception of the request message by T2S and the sending out of the corresponding acknowledgement message (see diagram above).

This KPI does not apply for request messages sent within files.

Measurement:

The response times for A2A requests are measured using the timestamps generated by the T2S network interface.

### 4.1.2.3 A2A response time for messages bundled in files

Definition:

---

<sup>9</sup> The EOD reporting phase is marked by the start of event EESR and the closure of event EEOR.

For all A2A requests bundled into files, the response time is defined as the time elapsed between the reception of the request file by T2S and the sending out of the corresponding acknowledgement message (see diagram above).

The acknowledgement message is only generated once the last message of the file has been processed.

Measurement:

The response times for A2A requests bundled into files, are measured using the timestamps generated by the T2S network interface.

### 4.1.2.4 U2A Response Time

Definition:

For all U2A requests the response time is defined as the time needed by the system to generate a web (HTML) page (i.e. the time it takes the server to generate the page, plus the time it takes the proxy to download the content from the server).

Measurement:

For U2A requests the response time is measured by the T2S Platform within the Eurosystem's domain. In order to limit the effect of queries with a large number of business objects retrieved the response time is computed assuming that the duration of each U2A request is equal to the monthly average response time of that kind of web page weighted by the frequency of the function invoked.

Calculation:

$$\frac{(a_1 * v_1) + (a_2 * v_2) + [...] + (a_n * v_n)}{h}$$

Where

a = average generation time of a functional category of GUI pages;

v = number of unique page views for each category of GUI pages;

h = total number of unique page views of T2S GUI pages.

### 4.1.2.1 Technical Validation Time<sup>10</sup>

Definition:

Technical Validation time indicator takes into account the time elapsed between the sending out of the acknowledgement message (after the reception of the request message) and the time the instruction is received by T2S, i.e. the time the instruction is passed on to the back-end module.

Measurement:

The Technical Validation Time is measured based on timestamps created by the T2S network interface (i.e. from the moment the technical ACK is sent out) and the timestamps measured at application level (e.g. Life Cycle Management and Matching domain for Settlement Instructions) and stored as part of the audit trail in the T2S database.

This KPI does not apply during the 10 minutes following either the end of the weekly Maintenance Window or the end of a daily Maintenance Window after a T2S closing day and during the EoD reporting phase.

### 4.1.2.2 Online Storage Period

The Online Storage Period defines the minimum time T2S keeps Transactional and Central Bank Static Data available online. The Transactional Data entities this period starts when the entity reaches its final status (i.e. settled, cancelled, etc.). For Static Data entities this period starts when the entity is no longer active and no longer referenced from a Transactional Data entity.

### 4.1.2.3 Archiving Period

The Archiving Period defines the minimum time T2S keeps Transactional and Central Bank Static Data available in an archive for retrieval by the [NCB]. For Transactional Data entities this period starts when the entity reaches its final status (i.e. settled, cancelled, etc.). For Central Bank Static Data entities this period starts when the entity is no longer active and no longer referenced from a Transactional Data entity.

---

<sup>10</sup> This KPI will enter into force as of the deployment of the R 6.2 to production environment.

### 4.1.2.4 Archive Retrieval Response Time

Definition:

The Archive Retrieval Response Time is defined as the time elapsed between the reception of an archive retrieval request and the sending out of the corresponding notification that the data is available for download.

Measurement:

The Archive Retrieval Response Time is measured using the timestamps generated by the T2S network interface.

### 4.1.3 Support Hours and Incident Response Times

These indicators define the response times of the T2S service desk in relation to the type of incident/request and the T2S Settlement Days. An incident is defined as any event which is not part of the standard operation of a service and which causes or may cause an interruption or a reduction in the quality of that service.

Incidents will be categorised in different priority classes considering both the impact on the availability of T2S Services as well as on Data Integrity and Confidentiality: the overall priority of an incident is always equal to the highest reported among the three impact categories.

The KPI for resolution time for each priority class is defined in 4.2.1.

# Currency Participation Agreement

## Schedule 6 – T2S Service Level Agreement

ECB-PUBLIC

Incident Priority	Severity	Availability Impact	Data Integrity Impact	Confidentiality Impact
1	Critical	<p>Complete unavailability of all T2S Services</p> <p>Complete unavailability of one or more services for which no workaround is available.</p>	<p>Massive data corruption, sensitive or proprietary information was changed or deleted, causing degradation or disruption of vital service(s), or affecting a large number of entities, involving a serious breach of network security, and there is a high reputational impact, e.g.</p> <ul style="list-style-type: none"> <li>• Credibility affected over the long term (&gt; 3 years)</li> <li>• Series of credible, verified and very negative pieces of information, and/or opinions</li> <li>• International media coverage extended to the popular press, TV and radio.</li> </ul>	<p>Massive extrusion of sensitive or proprietary information and there is a high reputational impact, e.g.:</p> <ul style="list-style-type: none"> <li>• Credibility affected over the long term (&gt; 3 years)</li> <li>• Series of credible, verified and very negative pieces of information, and/or opinions</li> <li>• International media coverage extended to the popular press, TV and radio</li> </ul>



# Currency Participation Agreement

## Schedule 6 – T2S Service Level Agreement

ECB-PUBLIC

2	Urgent	Unavailability of a service, but a workaround is available	<p>Significant data corruption, sensitive or proprietary information was changed or deleted, causing the degradation or disruption of non-essential service(s) or affecting a small number of entities, involving a breach of network security policy, and there is a medium reputational impact, e.g.</p> <ul style="list-style-type: none"> <li>• Credibility affected over the medium term (1 - 3 years)</li> <li>• Credible and negative pieces of information, and/or opinions</li> <li>• International media coverage including most internationally recognised newspapers.</li> </ul>	<p>Significant extrusion of sensitive or proprietary information and there is a medium reputational impact, e.g.:</p> <ul style="list-style-type: none"> <li>• Credibility affected over the medium term (1 - 3 years)</li> <li>• Credible and negative pieces of information, and/or opinions</li> <li>• International media coverage including most internationally recognised newspapers.</li> </ul>
3	Medium priority	All services are available, but some are experiencing performance problems	<p>Limited data corruption, sensitive or proprietary information was changed or deleted, causing the degradation of non-essential service(s), without affecting external entities, and there is a low reputational impact, e.g.</p> <ul style="list-style-type: none"> <li>• Credibility affected over short term (&lt; 1 year)</li> <li>• Negative pieces of information, and/or opinions</li> <li>• Media coverage in one or a few internationally recognised newspapers</li> </ul>	<p>Limited extrusion of sensitive or proprietary information low reputational impact, e.g.:</p> <ul style="list-style-type: none"> <li>• Credibility affected over short term (&lt; 1 year)</li> <li>• Negative pieces of information, and/or opinions</li> <li>• Media coverage in one or a few internationally recognised newspapers</li> </ul>
4	Low priority	Query or service request	No impact.	No impact.

### 4.1.3.1 Support Hours

Definition:

The T2S service desk can be contacted via telephone or e-mail by the [NCB]. During Standard Support Hours the T2S service desk can be contacted to communicate technical or business problems on the [NCB]'s side, open tickets for failures of T2S and receive support by the T2S Operator. During Non-standard Support Hours the T2S service desk should be initially contacted via telephone to communicate information that is urgently needed or useful to avoid or limit any negative impact on daily operations, as e-mails will not be monitored during this time. Any e-mail request that is sent during this time will be processed during the next standard support hours only, unless it is preannounced by a telephone call and related to an ongoing priority classes: class 1 or priority 2 incident, started outside standard support hours (see above).

### 4.1.3.2 Incident Response Time

Definition:

The Incident Response Time is defined as the time between the incident being detected or information about the incident received by the Eurosystem and the start of action to resolve the incident.

Measurement:

Upon acceptance of an incident or service request the T2S service desk will assign a reference number and a priority level to it. The reference number will allow the [NCB] to monitor the incident's status in the trouble management information tool.

Measurement is done based on the times recorded in the trouble management system.

### 4.1.3.3 Incident Resolution Time

Definition:

The Incident Resolution Time of an incident is the time between the start of action to resolve the incident and the time it is actually solved or a workaround is available.

### Measurement:

Upon acceptance of an incident or service request the T2S service desk will assign a reference number and a priority level to it. The reference number will allow the [NCB] to monitor the incident's status in the online trouble management information tool.

Measurement is done based on the time of the start of the incident as well as the time of its resolution as recorded in the Trouble Management System (TMS).

Unless the [NCB] formally objects promptly, both times above are the times recorded by the T2S service desk in the trouble management system.

### **4.1.4 Business Continuity and Disaster Recovery**

#### Objective:

The Business Continuity and Disaster Recovery mechanisms for T2S are designed to manage failures that require on-site recovery, alternate site recovery and alternate region recovery to ensure a high availability of the T2S Platform.

Business Continuity and Disaster Recovery scenarios will be categorised in the following classes:

Class	Description
Minor failure	Minor failure is understood as a short service interruption (e.g. due to component failures, a system reboot, or a line failure). These problems may typically be solved at the primary site.
Major failure	Major failure or disaster is understood as a serious service interruption (e.g. disruptions caused by fire, flood, terrorist attack or major hardware/ telecommunications faults). These events require the activation of the service in an alternative site.
Regional disaster	Regional disaster is understood as a "wide-scale regional disruption" causing severe permanent interruption of transportation, telecommunication, power or other critical infrastructure components across a metropolitan or geographical area and its adjacent communities; or resulting in a wide-scale evacuation or inaccessibility of the population within the normal commuting range of the disruption's origin.  These events require the activation of the service in an alternative region.

### 4.1.4.1 Recovery time

#### Definition:

The Recovery Time (RTO = recovery time objective) is defined as the maximum acceptable time to restart the T2S Platform after a failure.

#### Measurement:

The recovery time is measured from the decision to failover due to an incident that causes the unavailability of the T2S Platform as a whole (or significant parts of it) and the time the incident is resolved or a workaround is in place.

Where the agreed procedures foresee a consultation or decision of the Central Banks and the Participating CSDs, the time between informing them and their response is excluded from Recovery Time, as the time needed for reconciliation of lost data (see incident handling in chapter 3.1).

For the avoidance of doubt, activating the service in an alternative site (major failure) will preserve the status of instructions and transactions, both settled and non-settled. Within the constraints set by the recovery point objective (RPO) (4.1.4.2 below), this also applies to the re-activation of the service in an alternative region (regional disaster).

# Currency Participation Agreement

## Schedule 6 – T2S Service Level Agreement

ECB-PUBLIC

### 4.1.4.2 Recovery Point Objective

Definition:

The Recovery Point Objective (RPO = recovery point objective) is defined as the maximum acceptable time interval for which data sent to and by T2S is lost when a restart takes place.

Measurement:

The Recovery Point is a point of consistency to which a user wants to recover or restart. The RPO is measured as the amount of time between the moment when the point of consistency was created or captured and that when the failure occurred.

## 4.2 Committed Service Levels for the production environment

### 4.2.1 Operational and support services

Response times		
Online Storage Period (4.1.2.1)	90 days	
Archiving Period (4.1.2.3)	10 years	
Archive Retrieval Response Time (4.1.2.4)	72 hours	
Availability		
T2S Settlement Day	all calendar days except: Saturdays, Sundays, days where all the T2S settlement currencies are closed	
Weighted Availability parameters (4.1.1.2)	Service	Weight
	A2A Connectivity	As defined in the T2S Manual of Operational Procedures (T2S MOP)
	U2A Connectivity	
	Lifecycle Management and Matching	
Settlement		

# Currency Participation Agreement

## Schedule 6 – T2S Service Level Agreement

ECB-PUBLIC

		Liquidity Management	
		Static Data Management	
		Statistics, Queries, Reports, Archive	
		Operational Services	
	Weighted Availability value (4.1.1.2)	≥ 99.7 % / calendar month	
<b>Support hours and incident response times</b>			
	Standard Support Hours (4.1.3.1)	from 6:30 to 20:00 h on all T2S Settlement Days except:  1 May	
	Non-Standard Support Hours (4.1.3.1)	All times on T2S Settlement Days which fall outside the Standard Support Hours	
	Incident Response Time (4.1.3.2)	15 min. during standard support hours  60 min. during non-standard support hours	

# Currency Participation Agreement

## Schedule 6 – T2S Service Level Agreement

ECB-PUBLIC

Incident Resolution Time <sup>11</sup> (4.1.3.3)	Incident Priority	During standard support hours	Outside standard support hours
	1	2 hours	3 hours
	2	Before the start of the next Settlement Day (minimum 2 hours)	
	3	10 T2S Settlement days - subject to extension as agreed with requestor	
	4	Service Request or Queries <sup>12</sup>	
<b>Business Continuity and Disaster Recovery</b>			
Recovery Time: minor failure (4.1.4.1)	See Incident Response/Resolution Time		
Recovery Point Objective: minor failure (4.1.4.2)	No data loss		
Recovery Time: major failure (4.1.4.1)	< 60 minutes (from the decision to failover to the 2 <sup>nd</sup> site in the same region)		
Recovery Point Objective: major failure (4.1.4.2)	No data loss		
Recovery Time: regional disaster (4.1.4.1)	< 120 minutes (from the decision to failover to the other region)		
Recovery Point Objective: regional disaster (4.1.4.2)	< 2 minutes data loss		
<b>Business Continuity Tests<sup>13</sup></b>			
Intra-regional failover	To be tested every 6 months		
Inter-regional failover	To be tested every 6 months		

<sup>11</sup> The KPI will apply to incidents based on their Availability Impact. Refer to T2S MOP for the provisions on the resolution time of incidents with a Data Integrity and/or Confidentiality as defined in the relevant Incident and Crisis Management procedures.

<sup>12</sup> Refer to T2S MOP for Service Request Catalogue.

<sup>13</sup> The frequency will be effective as of 1<sup>st</sup> January 2023.

# Currency Participation Agreement

## Schedule 6 – T2S Service Level Agreement

ECB-PUBLIC

<b>Maintenance Windows</b>	
Start of weekly Maintenance Window	Saturday (or the calendar day following the last T2S Settlement Day in a week) 02:30 h
End of weekly Maintenance Window <sup>14</sup>	Monday (or the first T2S Settlement Day in a week) 02:30 h
Start of daily <sup>15</sup> Maintenance Window if activated	3:00 h
End of daily Maintenance Window if activated	5:00 h
<b>Punctuality</b>	
Punctuality value	100% / calendar month
Substantial Delay (4.1.1.3) <sup>16</sup>	10 minutes
Duration of the IDVP cut-off	10 minutes
Duration of the Start of Day Phase	75 minutes
Duration of the Night-time Settlement phase	210 minutes
Duration of the End of Day phase	45 minutes
Duration of the Penalty Mechanism daily processes	315 minutes
Monthly Billing Process <sup>17</sup>	Invoices to be sent on the 1 <sup>st</sup> Settlement day of the month by 12:00 h

### 4.2.2 Settlement services and liquidity management services

<b>System Performance</b>
---------------------------

<sup>14</sup> The Eurosystem stands ready to occasionally change the scheduled time of the end of the weekly Maintenance Window based on specific needs of either the [NCB] (e.g. issuance in direct holding countries) or of the Eurosystem itself).-For further information-please refer to the T2S MOP.

<sup>15</sup> The daily Maintenance Window is activated upon request of the T2S Operator. For further information please refer to the T2S MOP.

<sup>16</sup> For event MAGG, the respect of the KPI will not be represented as a percentage, rather with “On time/Not on time”.

<sup>17</sup> This will be effective as of 1<sup>st</sup> January 2023.



# Currency Participation Agreement

## Schedule 6 – T2S Service Level Agreement

ECB-PUBLIC

	Maximum Liquidity Transfer Settlement Time (4.1.1.77)	95% within 90 seconds  5% within 90 and 270 seconds
<b>System Capacity</b>		
	Margin for exceptional peaks	20% of the T2S System Capacity (ceiling) for the Number of instructions received, the Daily number of static data updates and Number of Securities Accounts (see chapter <b>Error! Reference source not found.</b> )  30 A2A queries per second (max 20.000 per hour)

### 4.2.3 Static Data services

<b>Availability</b>		
	Availability Period (4.1.1.1)	outside the Maintenance Window on all T2S Opening Days
	Static Data Processing Time (4.1.1.8)	99% within 20 seconds  1% within 20 and 120 seconds

# Currency Participation Agreement

## Schedule 6 – T2S Service Level Agreement

ECB-PUBLIC

### 4.2.4 Information services

<b>Availability</b>		
	Availability Period (4.1.1.1)	outside the Maintenance Window on all T2S Settlement Days
<b>Response times</b>		
	A2A Message Response Time (4.1.2.2)	99% within 20 seconds 1% within 20 and 270 seconds
	A2A Message in files Response Time (4.1.2.43)	99% within 60 seconds 1% within 360 seconds
	U2A Average Response Time (4.1.2.44)	3 seconds
	A2A Query Response Time for Simple Queries <sup>18</sup> (4.1.2.1)	95% within 20 seconds 5% within 20 and 120 seconds
	A2A Query Response Time for Complex Queries (4.1.2.1)	95% within 5 minutes 5% within 5 and 15 minutes

---

<sup>18</sup> The GFS (Version 4.0, page 582) defines the following queries as simple queries: Settlement Instruction Audit Trail Query, Securities Account Position Query, Securities Account Position History Query, T2S Dedicated Cash Account Balance Query, Outstanding Auto-Collateralisation Credit Query, Limit Utilisation Journal Query, Collateral Value of a Security Query, Securities Deviating Nominal Query, Securities CSD Link Query, Party List Query, Restricted Party Query, Securities Account List Query, T2S Dedicated Cash Account List Query, T2S Calendar Query, T2S Diary Query, System Entity Query, Attribute Domain Query, Attribute Value Query, Privilege Query, Role Query, T2S System User Query, Market-specific Restriction Query, SWIFT BIC Code Query, Report Configuration List Query, Report Configuration Detail Query, Report Query, Cumulative Invoice Query.

### 4.2.5 Connectivity services

System Performance		
	Maximum Business Validation Time (4.1.1.5)	99% within 60 seconds  1% within 60 and 180 seconds

### 4.3 Targeted Service Levels for the production environment

The more demanding, but non-binding target KPIs defined in this chapter reflect the service level, that is targeted by the Eurosystem. Even if these KPIs are not reached, but the service level is still within the range of the committed service levels (see chapter 4.2), this is no breach of the Service Level Agreement. However, in such a case the Eurosystem stands ready to jointly investigate ways to improve the service.

#### 4.3.1 Information services

Response times		
	A2A Query Response Time for Simple Queries <sup>19</sup> (4.1.2.1)	99% within 20 seconds  1% within 20 and 120 seconds
	A2A Query Response Time for Complex Queries (4.1.2.1)	99% within 5 minutes  1% within 5 and 15 minutes

---

<sup>19</sup> The GFS (Version 4.0, page 582) defines the following queries as simple queries: Settlement Instruction Audit Trail Query, Securities Account Position Query, Securities Account Position History Query, T2S Dedicated Cash Account Balance Query, Outstanding Auto-Collateralisation Credit Query, Limit Utilisation Journal Query, Collateral Value of a Security Query, Securities Deviating Nominal Query, Securities CSD Link Query, Party List Query, Restricted Party Query, Securities Account List Query, T2S Dedicated Cash Account List Query, T2S Calendar Query, T2S Diary Query, System Entity Query, Attribute Domain Query, Attribute Value Query, Privilege Query, Role Query, T2S System User Query, Market-specific Restriction Query, SWIFT BIC Code Query, Report Configuration List Query, Report Configuration Detail Query, Report Query, Cumulative Invoice Query.

### 5. Service Levels for the test environments

The non-binding target KPIs defined in this chapter reflect the Service Level, that is targeted by the Eurosystem for the test environments. Even if these KPIs are not reached there is no breach of the T2S Service Level Agreement. However, in such a case the Eurosystem stands ready to jointly investigate ways to improve the service.

#### 5.1 Service Levels for the Pre-Production environment<sup>20</sup>

##### 5.1.1 Operational and support services

<b>Support Hours</b>		
	Standard Support Hours (4.1.3.1)	07:00 – 19:30 h
<b>Availability</b>		
	Availability Value (4.1.1.22)	95 % / calendar month
	Availability Period (4.1.1.1)	From 7:00 to 19:00 hon all calendar days except:  Saturdays,  Sundays,  1 January,  Catholic/Protestant Easter Friday,  Catholic/Protestant Easter Monday,  1 May,  25 December,  26 December or  Days specified in the Pre-Production test environment calendar managed by the OMG.

<sup>20</sup> Please see Currency Participation Agreement, Schedule 3 – User Testing.

# Currency Participation Agreement

## Schedule 6 – T2S Service Level Agreement

ECB-PUBLIC

### 5.2 Service Levels for the Interoperability test environment<sup>21</sup>

#### 5.2.1 Operational and support services

Support Hours		
	Standard Support Hours (4.1.3.1)	07:00 – 19:30 h

#### 5.2.2 Availability

Availability		
	Availability Value (4.1.1.2)	85 % / calendar month
	Availability Period (4.1.1.1)	From 7:00 to 19:00 hon all calendar days except:  Saturdays,  Sundays,  1 January,  Catholic/Protestant Easter Friday,  Catholic/Protestant Easter Monday,  1 May,  25 December,  26 December or  Days specified in the Interoperability test environment calendar managed by the PMG.

---

<sup>21</sup> Please see Currency Participation Agreement, Schedule 3 – User Testing.

### 5.3 Additional provisions

The test environment can be opened with extended hours for a limited period upon request.

The Eurosystem will make all reasonable efforts to ensure that the operational hours of the test environments, including on-line availability for end-users and batch processing capabilities for the end of day procedures will be specified in the T2S User Testing Calendar and might be different for each of the testing environments.

In certain cases, such as the deployment of a new release, the Eurosystem reserves the right to change the T2S User Testing Calendar, which includes changing the opening and closing times of the test environments. All changes to the T2S User Testing Calendar shall be proposed, discussed and agreed in the substructure in charge of User Testing, before informing the T2S Users in a timely manner in advance.

The Information Security levels of the test environments shall be broadly the same as for the T2S production environment.

Regarding the capacity of the test environments, i.e. pre-production and interoperability environments they normally have jointly a capacity that is substantially lower compared to the production environment (10%<sup>22</sup> of the long-term capacity model for the system capacity ceiling of the production environment<sup>23</sup>) that, if needed, can be increased to reach the production levels.

The Eurosystem shall increase the capacity of the test environments to cover specific testing needs (e.g. high-volume tests during the community testing and the business day testing stages) upon a request from – and in agreement with – the [NCB].

The interoperability environment has allocated twenty-five calendar days<sup>24</sup> per year of production-like capacity<sup>25</sup> to support high-volume test activities such as migration and volume testing for the [NCB] as well as stress/performance testing and volume testing requested by the T2S Actors.

---

<sup>22</sup> 10% is to be intended as the capacity of the two test environments combined.

<sup>23</sup> This does not apply to the number of Securities Accounts. In case of direct-holding markets, the respective CSD will agree with the T2S Operator on the number of SACs to be configured in test environments, taking into consideration the test environments capacity.

<sup>24</sup> In case more days are required, the T2S Operator will provide them at no additional cost. The number of days allocated would be re-evaluated on a regular basis, based on the testing needs.

<sup>25</sup> Days when the full set of CPU processors is made available as in production.

# Currency Participation Agreement

## Schedule 6 – T2S Service Level Agreement

ECB-PUBLIC

---

The T2S service desk shall be the unique point of contact to report incidents and problems, and to ask for guidance on T2S during User Testing. The [NCB] can contact the T2S service desk via phone and email.

The T2S service desk coverage hours shall be aligned to the operation hours of the test environment referred to above.

### 6. System capacity and platform sizing

In order to ensure the proper sizing of the platform that is required to meet the agreed service levels, the CSDs are requested to provide on a quarterly basis updated forecasts for average and expected peak business figures as specified in the URD, to allow the Eurosystem to make an adequate long-term capacity planning. These figures have to include the volumes for the CSDs' DCA Holders as well.

Capacity requirements of Central Banks and Dedicated Cash Account Holders are expected to be negligible compared to capacity requirements of CSDs. Consequently, Central Banks are exempted from specifying any ex-ante capacity requirements. If the expectations change, the [NCB] will inform the Eurosystem.

In order to process exceptionally high peak volumes, the Eurosystem will ensure that additional capacity can be added on very short notice, provided no hardware components need to be replaced. However, there will be technical limitations to such a capacity increase.

If exceptional capacity is needed for a one-time event or on shorter notice, the Eurosystem will try to cope with such requests, but on best effort basis only.



### 7. Service Level reporting

End-to-end service reports including local service desk operations will be provided on a regular basis in electronic format, focusing on the above defined service metrics.

#### 7.1 Content of the Reporting

Performance against Service Level targets will be measured by the Eurosystem in compliance with the procedures agreed between the Parties.

Reports on actual service levels achieved will be provided to the [NCB] on a monthly basis. This will cover for each service indicator the performance achieved compared with the target values. For informational purposes the Eurosystem will also report the bilateral service levels achieved for the [NCB]. These reports are to be provided to the [NCB] within ten Settlement Days after the end of each month.

On a daily basis and reflected in the monthly SLA report:

- Actual service (including security) breaches
- Planned downtime
- Unplanned downtime
- Service availability<sup>26</sup>

On a monthly basis:

- Frequency of incidents
- Cumulative service breaches
- Use of T2S service desk (when relevant)
- Application and technology performance specified in this document (i.e. input/output file throughput, statistics on incoming/outgoing messages)
- Planned changes

---

<sup>26</sup> The Availability will be featured in the monthly report with a daily breakdown, whereas the calculation for the purpose of the KPI will remain on a monthly basis

- Previous month's unresolved incidents
- Previous month's resolved incidents
- Previous month's unresolved problems
- Previous month's resolved problems
- Comments and observations from the Eurosystem
- Medium term trends of incident and their root cause analysis
- Support figures (e.g. number of calls, response time, long abandon rate)
- Volume and capacity estimations as per the Long Term Capacity Planning provisions (see T2S MOP) for Production and Pre-production environments.

The SLA report will additionally feature a set of indicators for the test environments as defined in sections 5.1 and 5.2.

### 7.2 Definition of Additional Indicators for Reporting

This section defines additional indicators that are used for the reporting but have no KPI attached to it.

#### 7.2.1 File throughput

Definition:

The file throughput is defined as the minimum number of megabytes per hour that the interface subsystem has to be able to process in one hour independently for input and output.

Measurement:

The file throughput is measured by summing up the size of all files received during the reporting period and dividing this value by the actual processing time needed. The processing time is measured using the timestamps generated by the T2S network interface and as part of the T2S audit trail

#### 7.2.2 Batch Settlement throughput

Definition:

The Batch Settlement throughput is the ratio of the number of settlement instructions processed and the time that elapsed for processing them (i.e. between the start and end of the processing cycles).

All instructions that are ready for settlement are considered regardless of whether they have been settled or not.

Measurement:

The Batch Settlement throughput is measured based on timestamps stored as part of the audit trail in the T2S database.

Calculation:

$$R_n = \frac{I_n}{T_n}$$

Where:

R<sub>n</sub> = Batch Settlement throughput

I<sub>n</sub> = number of settlement instructions processed in Batch Settlement mode

T<sub>n</sub> = cumulated Batch Settlement processing time

### 7.3 T2S Operations report

The Eurosystem will complement the Service Level report with the T2S Operations report. The aim of the report is to provide information on operational activities, settlement statistics and follow up of Service Level monitoring. The report is prepared on a monthly basis by the Eurosystem and shared with the Operations Managers Group and the T2S Steering Level.

### 8. Monthly Service review meetings

The Eurosystem and all Connected NCBs will review the T2S service performance commitments during their regular meetings at Steering Level<sup>27</sup>. In addition, the Eurosystem will convene on a monthly basis or upon request a meeting of the Operations Managers Group (OMG) to review the T2S service performance on a working level.

This meeting will evaluate the service performance since the last review. In particular the meeting will:

- Review the service achievement (service level target against actual performance)
- Review the Service Level Reports provided in recent periods. However, for the sake of intra-annual comparability, the Service Level Report format might be changed only on a yearly basis.
- Focus particularly on breaches of service levels
- Identify weak areas and potential ways to address problems and initiate service improvement
- Preview issues (anticipated measures) for the coming period

---

<sup>27</sup> In case the Connected NCBs are having a permanent member in the Market Infrastructure Board (MIB), the review meeting is done in the MIB. Otherwise the review meetings are done in the Non-euro Currency Steering Group.

### 9. Annual SLA reviews

The Parties agree that the SLA will be reviewed on a yearly basis in order to verify the balance between evolving User requirements and defined T2S Service Levels, as well as to ensure the effectiveness of performance measuring criteria.

If required by the circumstances, the SLA can be reviewed on an ad-hoc basis.

Agreement review meetings provide an opportunity to review the agreement and associated targets.

In particular the meeting will:

- Review service achievements with the customer and identifying potential improvement on both sides
- Review the service requirements and identify if any changes have occurred
- Discuss any changes that operations would like to make to the agreement
- Agree on the next step for the SLA: extension, changes or decommissioning.

Changes to the SLA will be agreed in accordance with the applicable governance arrangements specified in Schedule 8 (Governance) of the CPA, in particular through the involvement of the Operations Managers Group.

All resulting changes to this SLA shall be approved by the Parties. In case of persistent disagreement between the Parties, the dispute resolution procedure laid down in the Currency Participation Agreement shall be activated.

### Annex 1 - Management of non-functional changes

#### 1. Emergency Changes

If an incident occurs, the Eurosystem may have to implement a change that cannot be delayed until the next planned Maintenance Window. The implementation of such a change will cause a system unavailability.

As a minimum, the Eurosystem will inform the [NCB] ex post about the reason for and the nature of the change. Nevertheless, the Eurosystem will make best efforts to inform the [NCB] ex ante, even at short notice.

#### 2. Other changes

By default, changes aimed at ensuring that the Eurosystem is capable of delivering the T2S Services according to the KPIs specified in this SLA or resulting from SLA reviews (see chapter 9), will be managed by the Eurosystem. If such changes have no impact on the [NCB], the Eurosystem will inform the [NCB] ex ante about the nature and the date of such change.

If such changes have an impact on the [NCB], or if the [NCB] expresses an interest in testing such changes, the Eurosystem and the [NCB] will co-operate in good faith to manage the changes, as much as possible and where relevant, following the provisions of Schedule 9 (Change and Release Management).

The dates reserved by the Eurosystem for implementing changes that have or might have an impact on the [NCB], are documented in a calendar that is shared and agreed in advance with the [NCB]. Changes to this calendar will be reported in the monthly reporting as described in section 7. By default, changes are implemented during a Maintenance Window.

The [NCB] is responsible to involve its DCA Holders in the process if necessary and share the relevant information with them.

# **CURRENCY PARTICIPATION AGREEMENT**

## **SCHEDULE 7**

### **PRICING**

# Currency Participation Agreement

## Schedule 7 – Pricing

---

### Table of contents

<b>1</b>	<b>Introduction .....</b>	<b>1</b>
<b>2</b>	<b>T2S Pricing policy .....</b>	<b>2</b>
<b>3</b>	<b>T2S price list .....</b>	<b>3</b>
<b>4</b>	<b>T2S Pricing structure .....</b>	<b>4</b>
4.1	Summary .....	4
4.2	Settlement services .....	4
4.3	Information services .....	13
4.4	Tariff items initially priced at zero .....	17
4.5	Tariff items priced at zero at least until end of cost-recover period .....	19
<b>5</b>	<b>Inventory of T2S Service Charges .....</b>	<b>21</b>
5.1	Introduction .....	21
5.2	Changes .....	21
5.2.1	T2S Common Changes .....	21
5.2.2	T2S Specific Changes .....	22
5.2.3	Pricing of assessments of Change Requests .....	22
5.3	RTGS fees for connecting to T2S .....	23
5.4	Training .....	23
5.5	Consultancy .....	23
5.6	Request for an additional test environment .....	23
5.7	Securities Reference Data .....	24
5.8	Connectivity Services .....	24
5.9	One-off joining fee .....	24
5.10	Exit Management .....	24
5.11	External Examiner .....	24



# Currency Participation Agreement

## Schedule 7 – Pricing

---

### 1      **1 Introduction**

2      The Schedule on Pricing consists of four components: (i) the T2S Pricing policy, which describes  
3      the Governing Council decision on the Pricing of T2S Services (ii) the T2S price list, which gives  
4      the actual T2S prices in eurocent for each of the T2S Services (i.e. settlement, account  
5      management and information services); (iii) the T2S pricing structure, which provides a detailed  
6      description of the items in the T2S price list, as well as the related fee triggers; and (iv) the  
7      Inventory of T2S Service Charges, which provides a description of how T2S will finance changes  
8      to T2S, and a number of other services not covered in the T2S pricelist.

9      All T2S prices are displayed on the T2S price list without VAT, which is not applied to T2S  
10     Services.

11     Following the establishment of the T2S pricing policy in 2010, the Eurosystem revised the  
12     pricing levels in 2018, seeking broad market advice. It will continue to do so when discussing  
13     possible changes to the Pricing Schedule.

# Currency Participation Agreement

## Schedule 7 – Pricing

---

### 14           **2   T2S Pricing policy**

15   The Governing Council of the European Central Bank (ECB) decided to set the   Delivery versus  
16   Payment price for TARGET2-Securities (T2S) at 15 eurocent per instruction. This price was  
17   fixed for the period from the T2S Go-Live Date (22 June 2015) until December 2018

18   The commitment to set the price at 15 eurocent was subject to the following conditions: (i)   non-  
19   euro currencies add at least 20% to the euro settlement volume; (ii) the securities settlement  
20   volume in the EU is no more than 10% lower than the volumes projected by the T2S Programme  
21   Office, which are based on market advice; and (iii) tax authorities confirm that   the Eurosystem  
22   will not be charged VAT for the T2S Services it provides.

23

24   In 2018, the Governing Council revised the pricing policy of T2S in the light of the start   of  
25   operations in June 2015, and of the end of the migration period in September 2017. In doing so, it  
26   agreed new baselines for the T2S Pricing with the market representatives, to continue   pursuing  
27   full cost recovery, whilst maintaining the pricing structure unchanged, in terms of the different  
28   weights for the tariff items.

29   The price list in Section 2 reflects the pricing level agreed within the updated   baselines,  
30   consisting in a basis DvP of 19.5 eurocent with an additional 4-eurocent surcharge linked to   the  
31   perspective volumes developments. The resulting figure of 23.5 eurocent remains the basis for  
32   the pricing structure.

# Currency Participation Agreement

## Schedule 7 – Pricing

33

### 3 T2S price list

<i>Tariff items</i>	<i>Price</i>	<i>Explanation</i>
<b>Settlement services</b>		
Delivery versus Payment	23.5	per instruction <sup>†</sup>
Free of Payment	14.1	per instruction <sup>†</sup>
Payment Free of Delivery	14.1	per instruction <sup>†</sup>
Internal T2S liquidity transfer	14.1	per transfer
Account allocation	4.7	per instruction <sup>†</sup>
Matching	4.7	per instruction <sup>†</sup>
Intra-position movement	9.4	per transaction
Intra-balance movement	9.4	per transaction
Auto-collateralisation service with Payment Bank	23.5	for issue and return, charged to collateral provider
Intended Settlement Date failed transaction	23.5	surcharge per Settlement Day failed per instruction <sup>††</sup>
Daytime settlement process	4.7	surcharge per instruction <sup>†</sup>
Daytime congestion charge	*	additional surcharge per instruction <sup>†</sup>
Auto-collateralisation service with Central Bank	*	for issue and return, charged to the collateral provider
Instruction marked with 'top or high priority'	*	surcharge per instruction <sup>†</sup>
Cancellation	*	per instruction <sup>†</sup>
Settlement modification	*	per instruction <sup>†</sup>
<b>Information services</b>		
A2A reports	0.4	Per business item in any A2A report generated
A2A queries	0.7	Per queried business item in any A2A query generated
U2A queries	10	Per executed search function
Messages bundled into a file	0.4	Per message in a file
Transmissions	1.2	Per transmission
<b>Account management services</b>		
Securities Account	Free of charge <sup>**</sup>	Fee options: a) monthly fee per ISIN in the account or b) monthly fee per account
Fee per T2S Dedicated Cash Account	0 <sup>***</sup>	Monthly

34

35

36

37

38

39

40

41

42

43

44

45

46

47

48

49

50

51

52

53

54

<sup>†</sup> Two instructions per transaction are charged.

<sup>††</sup> The auto-collateralisation with payment bank (i.e. client-collateralisation) is charged in line with the usage of T2S resources; only the collateral provider is charged. One collateralisation item plus both instructions of each auto-collateralisation leg are charged per ISIN and providing account, i.e. X cents \* 5 (i.e. 1 collateralisation item + 4 settlement instruction) for each auto-collateralisation service with payment bank, where X is the price of settlement instructions and collateralisation items.

\* T2S is sized in accordance with an expected consumption pattern, i.e. the anticipated distribution of settlement volumes during night-/day-time and peak hours. These items were initially be set at a zero price, presuming that actual usage of T2S would remain within this expected consumption pattern over time. However, should there be a stronger than expected use of T2S resources and the volume distribution pattern be different than expected thus adversely affecting T2S performance, it will be reconsidered to charge for these items. The Eurosystem regularly reviews the actual volumes against expected patterns for the different items.

\*\* Account management services for Securities Accounts are set at zero and will not be changed until the end of the cost recovery period, at least.

\*\*\* Account management services for T2S Dedicated Cash Accounts (DCAs) are not charged, presuming that the actual number and usage of DCAs will remain within expected consumption patterns. However, should DCAs involve a stronger than expected use of T2S resources thus adversely affecting T2S performance, it will be reconsidered to charge for these items. The Eurosystem regularly reviews the matter together with the Central Banks operating the DCAs.

# Currency Participation Agreement

## Schedule 7 – Pricing

### 55 4 T2S Pricing structure

#### 56 4.1 Summary

<i>Tariff items</i>	<i>DvP weight factor</i>	<i>Explanation</i>
<b>Settlement services</b>		
Delivery versus Payment	100%	per instruction
Free of Payment	60%	per instruction
Payment Free of Delivery	60%	per instruction
Internal T2S liquidity transfer	60%	per transfer
Account allocation	20%	per instruction
Matching	20%	per instruction
Intra-position movement	40%	per transaction
Intra-balance movement	40%	per transaction
Auto-collateralisation service with Payment Bank	100%	for issue and return, charged to collateral provider
Intended Settlement Date failed transaction	100%	surcharge per Settlement Day failed per instruction
Daytime settlement process	20%	surcharge per instruction
Daytime congestion charge	0%	additional surcharge per instruction
Auto-collateralisation service with Central Bank	0%	for issue and return, charged to the collateral provider
Instruction marked with 'top or high priority'	0%	surcharge per instruction
Cancellation	0%	per instruction
Settlement modification	0%	per instruction
<b>Information services</b>		
A2A reports	n/a	Per business item in any A2A report generated
A2A queries		Per queried business item in any A2A query generated
U2A queries		Per executed search function
Messages bundled into a file		Per message in a file
Transmissions		Per transmission
<b>Account management services</b>		
Securities Account	Free of charge	Fee options: a) monthly fee per ISIN in the account or b) monthly fee per account
Fee per T2S Dedicated Cash Account	0%	Monthly

57

58

#### 59 4.2 Settlement services

60 The general principle is that each completed settlement service activity are counted and reflected  
61 in the relevant monthly bill. Unless indicated otherwise, billable events are charged based on the  
62 date in which T2S successfully executes the related instructions/the events occur.

63 Two counterparties to a settlement transaction initiate one instruction each and the two  
64 instructions are then matched and form onetransaction.

65 The T2S Pricing structure aims at charging for resource usage in most instances. The price for  
66 settlement services is set relative to a DvPsettlement.

# Currency Participation Agreement

## Schedule 7 – Pricing

---

- 67 Each partial settlement<sup>1</sup> is charged separately (e.g. a settlement instruction settled in three parts is  
68 charged the DvP or FoP price three times, and any of the parts settled in the period 07:00 – 18:00  
69 will attract the daytime surcharge).
- 70 Conditional securities delivery<sup>2</sup> transactions are charged according to their individual  
71 components, e.g. DvP or FoP, matching, blocking and unblocking, creation of a condition and  
72 release of a condition, i.e. hold and release.
- 73 Section 4.4 contains the list of items which are initially set at a zero price, presuming that actual  
74 usage of T2S will be within the expected anticipated distribution of settlement volumes during  
75 night-/day-time and peak hours.
- 76 Section 4.5 contains the list of items which are priced at zero and will not be charged until the  
77 end of the cost recovery period, at least.

---

<sup>1</sup> Partial settlement is defined in the URD as “a process that settles only a fraction of settlement instructions original volume and amount when full settlement is not possible due to lack of securities. The residual unsettled volume and amount may settle at a later stage during the Intended Settlement Date. Any residual amount at the end of the intended settlement date results in the reporting of a failed settlement”.

<sup>2</sup> Conditional securities delivery is defined in the URD as “a procedure in which the final securities and/or cash booking is dependent on the successful completion of an additional action or event (e.g. registration of shares, cash settlement outside T2S)”.

# Currency Participation Agreement

## Schedule 7 – Pricing

---

### 78 Delivery versus Payment

<b>Price</b>	<b>Eurocent 23.5 per instruction</b>
<b>DvP weight factor</b>	<i>100% (the numeraire)</i>
<b>Background</b>	<i>The DvP requests a simultaneous transfer of securities versus cash. Both instructing parties are charged. The DvP price constitutes the numeraire for other instruction related charges (i.e. other instruction charges are indicated as a percentage of the DvP price). Realignment instructions resulting from a DvP are not charged.</i>
<b>Fee trigger</b>	<i>Each successfully completed DvP settlement.</i>

### 79 Free of Payment

<b>Price</b>	<b>Eurocent 14.1 per instruction</b>
<b>DvP weight factor</b>	<i>60%</i>
<b>Background</b>	<i>The FoP requests a transfer of securities only. There is no cash processing required. Both parties to the FoP are charged. Realignment instructions resulting from a FoP are not charged.</i>
<b>Fee trigger</b>	<i>Each successfully completed FoP settlement.</i>

### 80 Payment Free of Delivery

<b>Price</b>	<b>Eurocent 14.1 per instruction</b>
<b>DvP weight factor</b>	<i>60%</i>
<b>Background</b>	<i>The PFOD requests a transfer of cash only. There is no securities processing required. Both parties to the PFOD are charged. Realignment instructions resulting from a PFOD are not charged.</i>
<b>Fee trigger</b>	<i>Each successfully completed PFOD settlement.</i>

81

# Currency Participation Agreement

## Schedule 7 – Pricing

---

### 82 Internal T2S liquidity transfer

<b>Price</b>	<b>Eurocent 14.1 per transfer</b>
<b>DvP weight factor</b>	60%
<b>Background</b>	<p><i>Internal liquidity transfers between two T2S Dedicated Cash Accounts are charged with a DvP weight factor of 60%.</i></p> <p><i>Liquidity transfer charges are invoiced to T2S Users via the T2S Users' Central Bank.</i></p> <p><i>Payments triggered as part of a DvP are included within the DvP instruction charge.</i></p>
<b>Fee trigger</b>	<p><i>All successfully executed liquidity transfers between two T2S Dedicated Cash Accounts.</i></p> <p><i>The fee is charged to the instructing party, i.e. the debited party.</i></p>

### 83 Account allocation

<b>Price</b>	<b>Eurocent 4.7 per instruction</b>
<b>DvP weight factor</b>	20%
<b>Background</b>	<p><i>An account allocation in a “direct holding market” is an instruction involving at least one Securities Account which has been flagged as an “end-investor account” in T2S. Two instructions per transaction are charged. If the account allocation instructions are sent unmatched, the Matching fee is charged in addition. The definitions of a “direct holding market” and “end-investor account” in the context of the T2S Pricing Schedule are provided below.</i></p> <p><b><i>For the purpose of T2S Pricing, a “direct holding market” is defined as a market:</i></b></p> <ol style="list-style-type: none"><li><i>1. in which, at a minimum, for holdings of domestic securities generally held by domestic residents, end-investors (retail investors in particular) would generally have an account directly in the Issuer CSD; and</i></li><li><i>2. which brings all segregated end-investor accounts to T2S that contain securities that are available in T2S.</i></li></ol> <p><i>For the purpose of T2S Pricing, the following markets are considered as direct holding markets according to paragraph 1: Cyprus, Denmark, Estonia,</i></p>

# Currency Participation Agreement

## Schedule 7 – Pricing

---

*Finland, Greece, Iceland, Malta, Norway, Romania, Slovakia, Slovenia, Sweden. This list is subject to review by the T2S Governance bodies when needed, following the procedure for ‘Decision-making on relevant matters other than Change Requests’ in Schedule 8 (Governance).*

***Definition of “end-investor accounts” and instructions eligible for the reduced account allocation fee***

*For the purpose of T2S Pricing, there are two options which a CSD serving a direct holding market in T2S can choose with respect to the definition of “end investor accounts and the instructions which are eligible for the account allocation fee:*

***Option A for a direct holding market in T2S:***

- a. All segregated accounts of customers of CSD participants are eligible to be flagged as ‘end-investor account eligible for the account allocation fee’. It is the responsibility of the respective CSD in a direct holding market in T2S in cooperation with its participants to ensure a proper flagging of accounts.*
- b. FoP instructions involving at least one account flagged as ‘end-investor account eligible for the account allocation fee’ are charged the account allocation fee which is applicable to both sides of the FoP transaction.*

*Or:*

***Option B for a direct holding market in T2S:***

- a. All retail investor accounts are eligible to be flagged as ‘end-investor account eligible for the account allocation fee’. A retail investor means a ‘retail client’ in the meaning of MiFID II (OJ L 173 12.6.2014). It is the responsibility of the respective CSD in a direct holding market in T2S in cooperation with its participants to ensure a proper flagging of accounts.*
- b. DvP and FoP instructions involving at least one account flagged as ‘end-investor account eligible for the account allocation fee’ are charged the account allocation fee which is applicable to both*



# Currency Participation Agreement

## Schedule 7 – Pricing

---

	<p><i>sides of the transaction.</i></p> <p><b><i>The following principles apply to account allocations:</i></b></p> <ol style="list-style-type: none"><li><i>1. The objective of the fee for account allocations is to ensure a level playing field in T2S between direct and indirect holdingmarkets.</i></li><li><i>2. As a principle, the account allocation fee should not be used for transactions in direct holding markets in T2S that would have been charged the full price in an average indirect holding market or in an average direct holding market opting for a layered model inT2S.</i></li><li><i>3. In line with the transparency principle of T2S, the T2S Board reports on an annual basis about the share of DvP transactions, FoP transactions and Account allocations in each of the respective direct holding markets in T2S. This report includes the share of DvP transactions and FoP transactions of the aggregated indirect holding markets in T2S for comparison.</i></li></ol>
<b>Fee trigger</b>	<p><i>The fee trigger depends on which option A or B is chosen by the respective CSD serving a direct holding market in T2S:</i></p> <ul style="list-style-type: none"><li><i>• Option A. Any FoP instruction involving at least one account flagged as ‘end-investor account eligible for the account allocation fee’ is charged the account allocation fee, which is applicable to both sides of the FoP transaction.</i></li></ul> <p><i>Or:</i></p> <ul style="list-style-type: none"><li><i>• Option B. Any DvP or FoP instruction involving at least one account flagged as ‘end-investor account eligible for the account allocation fee’ is charged the account allocation fee, which is applicable to both sides of the transaction.</i></li></ul>

# Currency Participation Agreement

## Schedule 7 – Pricing

---

### 85 Matching

<b>Price</b>	<b>Eurocent 4.7 per instruction</b>
<b>DvP weight factor</b>	20%
<b>Background</b>	<p><i>An unmatched instruction will have to pass through the Matching process and will assume additional processing resources of T2S. Therefore, it attracts a standard Matching charge on top of the regular settlement instruction fee.</i></p> <p><i>The Matching charge is 20% of a DvP instruction charge and is applied to both parties.</i></p>
<b>Fee trigger</b>	<i>Each successfully completed Matching event.</i>

### 86 Intra-position movements

<b>Price</b>	<b>Eurocent 9.4 per transaction</b>
<b>DvP weight factor</b>	40%
<b>Background</b>	<p><i>All intra-position movements in the case of securities (i.e. blocking/ unblocking/ reservation/ unreservation/ earmarking / unearmarking) attract an instruction-based fee. Internally generated intra-position movements are also charged.</i></p> <p><i>For example, say a securities position is blocked for a specific DvP transaction. Once the DvP transaction which is using the blocked securities is ready to be settled, T2S will first have to unblock the securities position so the DvP can settle. This unblocking is charged. Examples are available in the UDFS.</i></p> <p><i>No fees are applied for the blocking of static data (i.e. of the Party, Securities Account). The intra-position movement fee are charged to respective T2S Users via their CSD.</i></p>
<b>Fee trigger</b>	<i>Any successfully executed intra-position movement.</i>

87

# Currency Participation Agreement

## Schedule 7 – Pricing

---

### 88 Intra-balance movements

<b>Price</b>	<b>Eurocent 9.4 per transaction</b>
<b>DvP weight factor</b>	40%
<b>Background</b>	<i>All intra-balance movements in the case of cash (i.e. blocking/unblocking) attract an instruction-based fee. Internally generated intra-balance movements are also charged. The fees are also applied for the automatic release of cash blockings during end-of-day and the regenerated cash blockings at the next start-of-day in the case of a Conditional Securities Delivery (CoSD).  No fees are applied for the blocking of static data (i.e. of the Party, Securities Account). The intra-balance (cash) movement fee are charged to respective T2S Users via their Central Bank.</i>
<b>Fee trigger</b>	<i>Any successfully executed intra-balance movement.</i>

### 89 Auto collateralisation service with Payment Bank

<b>Price</b>	<b>Eurocent 23.5 per transaction</b>
<b>DvP weight factor</b>	100%
<b>Background</b>	<i>The complete auto-collateralisation with a Payment Bank attracts an all-in-one fee of 100% DvP weight factor for issue and return: one collateralisation item plus both instructions of each auto-collateralisation leg are charged per ISIN and providing account. Only the collateral provider is charged.</i>
<b>Fee trigger</b>	<i>Each successfully executed auto-collateralisation transaction with a Payment Bank within the monthly billing period.</i>

### 90 Fail on Intended Settlement Date

<b>Price</b>	<b>Eurocent 23.5 per instruction</b>
<b>DvP weight factor</b>	100%
<b>Background</b>	<i>Matched settlement instructions failing to settle on their Intended Settlement Date (ISD) are re-introduced into all the future settlement cycles until they either settle or are cancelled by the two counterparties. The <u>daily charge</u> addresses the resource cost of congestion and of the additional processes required to recycle a failed transaction, e.g. eligibility checking. Disciplinary actions are not applied by T2S through its price list. Both parties of the failing</i>

# Currency Participation Agreement

## Schedule 7 – Pricing

---

	<i>settlement transaction will attract the charge.</i>
<b>Fee trigger</b>	<i>Each Matched DvP, FoP, or PFOD which does not settle on its Intended Settlement Date attracts a surcharge. Furthermore, the surcharge is applied for every Settlement Day that the instruction fails to settle after the ISD. The charge is applied to both parties of the transaction.</i>

### 91 Daytime settlement process

<b>Price</b>	<b>Eurocent 4.7 <u>surcharge</u> per instruction settled during the period 07:00 - 18:00</b>
<b>DvP weight factor</b>	20%
<b>Background</b>	<i>Settlement instructions successfully executed during the period 07:00 – 18:00 attract a 20% “daytime surcharge”.</i>
<b>Fee trigger</b>	<i>Any DvP, FoP or PFOD instruction successfully settled during the period 07:00 – 18:00 attract the daytime surcharge.</i>

92

# Currency Participation Agreement

## Schedule 7 – Pricing

---

### 93 4.3 Information services

94

95 Reports, queries and messages of Directly Connected Parties (which are entitled to do so by the  
96 respective CSD) are charged to the CSD of the Directly Connected Party. Reports, queries and  
97 messages of a Payment Bank are charged to the Central Bank of the Payment Bank. Reports,  
98 queries and messages that are received/generated during peak hours, i.e. the last two hours prior  
99 to the DvP cut-off time (i.e. indicatively between 2 p.m. – 4 p.m.), may be subject to the daytime  
100 congestion surcharge.

101 For the purposes of the pricing of information services, the following definitions are used:

- 102 ▪ A **‘business item’** is one instance of a business entity defined in the T2S data model (e.g.  
103 settlement instruction, securities position, intra-balance movement, liquidity transfer,  
104 cash posting, Securities Account, Dedicated Cash Account etc) with all its attributes.
- 105 ▪ A **‘message’** is an encrypted inbound/outbound communication used for Application-to-  
106 Application (A2A) interactions between T2S and its participants. A complete list of all  
107 messages is available in Chapter 3 of the User Detailed Functional Specifications  
108 (UDFS).
- 109 ▪ A **‘file’** is a structured collection of ‘messages’.
- 110 ▪ A **‘transmission’** can be any of the following: a ‘message’, a ‘file’, an ‘A2A query  
111 request’, ‘A2A query response’ or an ‘A2A report’.

112

### 113 **A2A reports**

<b>Price</b>	<b>Eurocent 0.4 per business item in an A2A report</b>
<b>Background</b>	<i>A2A reports are charged based on the reported number of business items. The list of A2A reports and associated business item is included in Annex 1 to Schedule 7.</i>
<b>Fee trigger</b>	<i>Any A2A report generated, with the charge based on the reported number of business items.</i>

### 114 **A2A queries**

<b>Price</b>	<b>Eurocent 0.7 per queried business item in an A2A query</b>
<b>Background</b>	<i>A2A queries are charged based on the number of queried business items. The list of A2A queries and associated business item is available in Annex 1 to Schedule 7.</i>

# Currency Participation Agreement

## Schedule 7 – Pricing

---

<b>Fee trigger</b>	<i>Any A2A query generated, with the charge based on the number of queried business items.</i>
--------------------	--

### 115 **U2A queries**

<b>Price</b>	<b>Eurocent 10 per executed U2A query</b>
<b>Background</b>	<i>U2A queries are submitted via the GUI and the U2A query response is received by the GUI. U2A queries viewed on the GUI are charged a fixed fee per executed query.  If a U2A query were downloaded/exported, then it is charged in the same manner as for A2A queries (i.e. per business item in the downloaded U2A query). The list of U2A queries and associated business item is available in Annex 1 to Schedule 7.</i>
<b>Fee trigger</b>	<i>Any executed U2A search function viewed on the GUI would be charged a fixed fee.  If a U2A query is downloaded, it would be additionally charged in the same manner as for A2A queries (i.e. per queried business item).</i>

116

# Currency Participation Agreement

## Schedule 7 – Pricing

---

### 117 Messages bundled into a file

<b>Price</b>	<b>Eurocent 0.4 per message in each file containing bundled messages</b>
<b>Background</b>	<i>T2S Actors have the possibility to send messages to T2S and receive messages from T2S bundled together into a file. Messages received by T2S which are not accepted or not successful authenticated are not charged for.</i>
<b>Fee trigger</b>	<i>Each file containing bundled messages, with the charge based on the number of messages in the file.</i>

### 118 Transmissions

<b>Price</b>	<b>Eurocent 1.2 per transmission</b>
<b>Background</b>	<i>All types of transmissions (with the exception of technical acknowledgement messages) are counted and charged for.</i>
<b>Fee trigger</b>	<i>Each transmission per T2S Party (both inbound and outbound) is counted and charged for (except for technical acknowledgement messages).</i>

119

# Currency Participation Agreement

## Schedule 7 – Pricing

120 Some worked examples for the pricing of informationservices:

Item	Transmission fee (in eurocent)	Business item fee (in eurocent)	Fixed fee	Total charge
A2A query request to a T2S Actor containing 100 business items	1.2 eurocent (for sending the report)	40 eurocent (100 x 0.4 eurocent for each business item contained in the report)	-	41.2 eurocent
A file containing 100 messages, sent by a T2S Actor to the T2S Platform	1.2 eurocent (for receiving the file)	40 eurocent (100 x 0.4 eurocent for each message bundled into the file)	-	41.2 eurocent
A2A query request and the subsequent response containing 100 business items	2.4 eurocent (1.2 eurocent for the A2A query request message and 1.2 eurocent for the A2A query response)	70 eurocent (100 x 0.7 eurocent for each queried business item)	-	72.4 eurocent
100 (individual) messages sent by T2S to a T2S Actor	120 eurocent (100 x 1.2 eurocent for each message)	-	-	120 eurocent
U2A query on the GUI	-	-	10 eurocent	10 eurocent
U2A query containing 100 business items, viewed on the GUI and then subsequently downloaded	-	70 eurocent (100 x 0.7 eurocent for each queried business item)	10 eurocent (for the initial viewing on the GUI)	80 eurocent

121

122



# Currency Participation Agreement

## Schedule 7 – Pricing

---

### 123 4.4 Tariff items initially priced at zero

124 T2S is sized in accordance with expected consumption patterns, i.e. the anticipated distribution of  
125 settlement volumes during night-/day-time and peak hours. The items in this section are set at a  
126 zero price, presuming that actual usage of T2S remains within these expected consumption  
127 patterns over time. However, should there be a stronger than expected use of T2S resources and  
128 the volume distribution pattern be different from expected thus adversely affecting T2S  
129 performance, these items may be charged. The Eurosystem regularly reviews the actual usage of  
130 T2S resources against expected consumption patterns.

### 131 Daytime congestion charge

<b>Price</b>	<b>Zero eurocent per instruction</b>
<b>DvP weight factor</b>	0%
<b>Background</b>	<i>An additional congestion surcharge may be applied to settlement instructions successfully executed during the last two hours prior to the DvP cut-off time (i.e. indicatively between 14:00 – 16:00). Initially this “congestion charge” is set at 0 eurocent but if it is found that too many instructions are executed during the period and hence causing congestion, a fee may be applied.</i>
<b>Fee trigger</b>	<i>Any DvP, FoP or PFOD instruction successfully settled during the last two hours prior to the DvP cut-off time (i.e. indicatively between 14:00 – 16:00) would attract the daytime congestion surcharge.</i>

### 132 Auto collateralisation service with a Central Bank

<b>Price</b>	<b>Zero eurocent per transaction</b>
<b>DvP weight factor</b>	0%
<b>Background</b>	<i>All transactions resulting from auto-collateralisation with a Central Bank would be charged an all-in-one fee. Only the collateral provider would be charged.</i>
<b>Fee trigger</b>	<i>All successfully processed auto-collateralisation transactions with a Central Bank within the monthly billing period.</i>

### 133 Daytime settlement of ‘high’ priority and ‘top’ priority instructions

<b>Price</b>	<b>Zero eurocent per instruction</b>
<b>DvP weight factor</b>	0%

# Currency Participation Agreement

## Schedule 7 – Pricing

<b>Background</b>	<p>All ‘Top Priority’ and ‘High Priority’ instructions processed during the period 07:00 – 18:00 would be subject to a surcharge.</p> <p><i>TOP priority = default assigned to instructions fulfilling predetermined criteria, such as those of trading platforms (multilateral trading facilities, Stock Exchanges, etc.) with and without a central clearing counterparty (CCP) as well as over the counter (OTC) instructions with a CCP (URD 7.2.2.2). Special instructions assigned by Central Banks or CSDs with a ‘reserved priority’ (e.g. Central Bank monetary policy operations) would attract the same charge.</i></p> <p><i>HIGH priority = can be assigned by T2S Users to OTC transactions (without CCP) in the relevant settlement instruction. High priority instructions follow in the processing hierarchy after top priority instructions (URD7.2.2.3).</i></p>
<b>Fee trigger</b>	<p>Instructions flagged with ‘Top Priority’ or ‘High Priority’ which are settled in the period 07:00 – 18:00. If a CSD’s priority traffic exceeds 20% of its total settlement volume within the monthly billing period, the Eurosystem discusses the matter with the respective CSD to assess the reason for such high usage. Should usage not be brought into a range below 20%, the CSD will be billed for the priority fee and charges may apply after a notification period of 60 days.</p>

### 134 Cancellation

<b>Price</b>	<b>Zero eurocent per instruction</b>
<b>DvP weight factor</b>	0%
<b>Background</b>	<p><i>The cancellation of a settlement instruction which had been submitted previously needs to be validated and the original settlement instruction is flagged as successfully cancelled. In cases where the instruction has already been matched, each side of the cancellation would be charged. Cancellation instructions which are not successfully executed or have been denied are not charged.</i></p>
<b>Fee trigger</b>	<p><i>All instructions that have been successfully cancelled. Successful automatic cancellation of settlement instructions by the Instruction Maintenance Module would also be charged. All previously attracted chargeable status (e.g. Matched, partial settlement, Intended Settlement Date fail) would be charged as well.</i></p>

# Currency Participation Agreement

## Schedule 7 – Pricing

---

### 135 Settlement modification

<b>Price</b>	<b>Zero eurocent per instruction</b>
<b>DvP weight factor</b>	0%
<b>Background</b>	<i>Settlement instruction modifications include any change of the Hold status (CSD hold status/ CSD validation hold status/ party hold status/ CoSD hold status), all release instructions, change of priority, change of partial settlement indicator and linkage block.</i>  <i>All relevant default settings do not attract a charge because they are driven by the relevant static data.</i>
<b>Fee trigger</b>	<i>Any successfully executed settlement modification instruction leading to a change in status.</i>

### 136 Fee per T2S Dedicated Cash Account

<b>Price</b>	<b>Zero euro monthly per T2S Dedicated Cash Account</b>
<b>Background</b>	<i>Monthly fixed fee to cover for the maintenance of the static data.</i> <i>This fee would be charged to respective T2S Users via their Central Bank.</i>
<b>Fee trigger</b>	<i>Any T2S Dedicated Cash Account with the account status 'open' at the end of the monthly billing period or if it was closed during the billing period.</i>

### 137 **4.5 Tariff items priced at zero at least until end of cost-recovery period**

### 138 Securities Account fees

139 Securities Account fees are set at zero at least until the end of the cost recovery period.

<b>Price</b>	<b>Option a) Zero eurocent monthly per ISIN in a Securities Account</b> <b>Option b) Zero euros monthly per Securities Account</b>
<b>Background</b>	<i>Increased numbers of ISINs in an account in general means more resource associated with maintaining static data for the account. T2S parties have the choice between:</i>  <i>Option a) each Securities Account open in the database of T2S and active during the billing period attracts a monthly fixed fee which is applied for each ISIN held in the account; or</i>  <i>Option b) each Securities Account open in the database of T2S attracts a monthly fixed fee to cover for the maintenance of a Securities Account static data.</i>  <i>Should CSDs offer the option. T2S Users can choose which option to be</i>

# Currency Participation Agreement

## Schedule 7 – Pricing

---

	<i>applied. The decision should be stable in the long term.</i>
<b>Fee trigger</b>	<i><u>Option a)</u> All ISIN positions at the end of the monthly billing period within a Securities Account which was active during the billing period and the account flagged to be charged by ISIN attracts a fixed fee per ISIN position in the account <u>Option b)</u> Any Securities Account <u>not</u> flagged to be charged by ISIN with the account status 'open' at the end of the monthly billing period attracts a fixed fee. This fixed fee is also applied to accounts closed during the billing period.</i>

140

# Currency Participation Agreement

## Schedule 7 – Pricing

---

### 141        **5    Inventory of T2S Service Charges**

#### 142        **5.1    Introduction**

143        The Inventory of T2S Service Charges (the Inventory) provides T2S Users with a description    of  
144        how T2S will finance changes (which, depending on the type of change, could potentially    result  
145        in increases    of T2S prices included in the T2S    price list), and a    number of other services    not  
146        covered in the T2S price list. The present content of the Inventory is not    necessarily exhaustive,  
147        but could potentially be expanded to encompass other types of service charges. If the list were to  
148        be expanded at a later stage, the general principle of charging at cost shall remain.

#### 149        **5.2    Changes**

150        The process for how changes will be implemented to the T2S Services is described in Schedule 9  
151        on ‘Change and Release Management’. The following section describes how the costs for  
152        Common Changes and Specific Changes of the T2S Services are to be recovered.

##### 153        **5.2.1    T2S Common Changes**

154        Common Changes are defined as “any new feature, functionality or service – or any amendment  
155        of an existing feature, functionality or service – which is implemented for the benefit of    all T2S  
156        Actors”. Prior to going ahead and implementing a Change Request, the Eurosystem will    specify  
157        the development and running costs of the change. This will be a binding offer on behalf of the  
158        Eurosystem.

159        Those Common Changes that are classified as “corrective maintenance” (i.e. fixing of errors    in  
160        coding, design or detailed specifications (bug fixes)” and “technical maintenance” (i.e.    software  
161        adaptations and/or testing activities imposed by changes of the hardware or the operating    system  
162        or other infrastructural software packages within certain resource limits) will not be charged  
163        separately.

164        All other Common Changes will first need to be financed by the Eurosystem and the    Governing  
165        Council needs to decide to increase the financial envelope of T2S by the cost    of such a change.  
166        Substantial increases in the financial envelope could result in the need to adjust the T2S price list  
167        at some stage and/or to lengthen the amortisation period and/or to establish separate amortisation  
168        cycles. The development costs, running costs and capital costs associated with these Common  
169        Changes will therefore have to be recovered through T2S fees (see T2S price list) over an  
170        amortisation period.

# Currency Participation Agreement

## Schedule 7 – Pricing

---

171 CSDs commit to bear any residual costs related to Common Changes requested by them that  
172 cannot be recovered through T2S fees.

### 173 5.2.2 T2S Specific Changes

174 Specific Changes are defined as “any new feature, functionality or service – or any amendment of  
175 an existing feature, functionality or service – which is not supported by all T2S Actors”. Based  
176 on the principle of non-exclusiveness and non-discrimination, the functionality would in principle  
177 be available to all initial and future T2S parties. However, those not wishing to use the new  
178 functionality would not be impacted and therefore would not bear any of the costs.

179 Prior to a Specific Change Request being approved, the Eurosystem will specify the full financial  
180 consequences associated with the change (e.g. the implementation costs, the running costs,  
181 capital costs and potentially lost revenues). The estimate of the implementation costs will be a  
182 binding offer on behalf of the Eurosystem.

183 Once the Specific Change Request has been approved and before the Eurosystem starts  
184 development activities, the entities requesting the change (“requesters”) will formally commit to  
185 bear the full financial consequences of the change and agree with the T2S Board on the financing  
186 of the Specific Change. The financing of Specific Changes may be in the form of either pre-  
187 financing, financing via transaction fees levied on the use of the specific functionality or any  
188 other recovery method to be agreed between the requesters and the T2S Board.

189 Entities which have not been part of the original agreement between the Eurosystem and the  
190 requesters to develop a specific functionality but decide to use such functionality at a later stage  
191 (“late-joiners”) will have to bear an appropriate share of the financial consequences. The  
192 requesters that initially requested the specific functionality shall seek an agreement with the late-  
193 joiner(s) for the revised allocation of financial consequences of such functionality. If original  
194 requesters and the late-joiner(s) cannot find an agreement on the revised allocation of the full  
195 financial consequences of that functionality, a panel of experts (nominated by CSDs in line with  
196 Arbitration rules) will decide on a revised allocation, using objective criteria in order to ensure  
197 non-discrimination, to avoid duplication of Specific Changes and to keep T2S open for new  
198 developments. Subject to the late-joiner having paid or committed to pay its share of the full  
199 financial consequences of the Specific Change in accordance with the revised allocation, it will  
200 be able to use the specific functionality.

### 201 5.2.3 Pricing of assessments of Change Requests

202 Preliminary assessments of a request for a functional change will attract a charge of €2,000. If,  
203 based on the results of the preliminary assessment, the party then decides to request a detailed

# Currency Participation Agreement

## Schedule 7 – Pricing

---

204 assessment for the functional change, the detailed assessment will attract an additional charge of  
205 €10,000.

206 If the Change Request is subsequently approved and implemented, either as a Common Change  
207 or Specific Change, the costs of the preliminary and detailed assessments will be added to the  
208 total cost of the change (and recovered in the manner described in sections 5.2.1 and 5.2.2).

209 If the change is rejected, the costs of the preliminary and detailed assessment would be charged  
210 directly to the requester. In case there is more than one requester, the costs of the preliminary  
211 assessments and detailed assessments would be distributed equally.

### 212 5.3 RTGS fees for connecting to T2S

213 If an RTGS system charges T2S a fee for connecting to T2S, T2S will not charge this fee to its  
214 Contracting CSDs. T2S will annually charge such fee back to the Central Bank that operates the  
215 T2S Dedicated Cash Account in the currency in which the RTGS system operates. As a matter of  
216 service, T2S will annually provide each Central Bank operating a T2S Dedicated Cash Account  
217 with each Payment Bank's annual share in the total number of postings on that T2S Dedicated  
218 Cash Account and the Central Bank might take that into account when allocating the charges.

### 219 5.4 Training

220 The Eurosystem will provide training by qualified trainers to interested parties on the structural  
221 and operational aspects of T2S. Such general training which T2S offers to all T2S Stakeholders  
222 will be free of charge. Tailor-made training will be charged to the requesting party on a per diem  
223 basis. The Eurosystem will charge training services at cost. T2S training course offerings and  
224 associated charges will be published on a regular basis.

### 225 5.5 Consultancy

226 The Eurosystem may provide resources on request of a CSD, Central Bank or a Directly  
227 Connected Party to provide advice and support improving their technical infrastructure  
228 interaction with the T2S platform. Specific consultancy will be charged to the requesting party on  
229 a per diem basis. The Eurosystem will charge the consultancy services that it provides at cost.

### 230 5.6 Request for an additional test environment

231 The Eurosystem will be providing two test environments for User Testing during migration and  
232 post-migration without charging any additional service charge.

233 The Eurosystem will provide additional test environments subject to an approved Change  
234 Request. If CSDs/Central Bank would require additional test environments, the set-up costs of

# Currency Participation Agreement

## Schedule 7 – Pricing

---

235 the test environment as well as daily maintenance fees will be charged at cost either as a  
236 Common or a Specific Change.

237 If the additional test environment(s) is charged as a Specific Change, the fee will be included in  
238 the respective CSD/Central Bank bill as soon as the relevant test environment is ready for testing.

### 239 **5.7 Securities Reference Data**

240 If the Eurosystem were to provide the securities maintaining services to CSDs, it will charge  
241 these services at cost.

### 242 **5.8 Connectivity Services**

243 [The Eurosystem allows all CSDs and NCBs, and their customers, i.e. Directly Connected Parties  
244 and Dedicated Cash Account holders respectively, to connect to T2S via two types of  
245 connectivity: (i) a Dedicated Link connection, and (ii) a Value Added Network. The Eurosystem  
246 will charge the set-up and operation of its Dedicated Link connection at cost to the Directly  
247 Connected Actors using such a connection. In addition, the Eurosystem will charge each Directly  
248 Connected Actor with a one-off fee of EUR [...] for the issuance of each requested security  
249 certificate and an annual fee of EUR [...] for the annual prolongation of each security certificate.]

### 250 **5.9 One-off joining fee**

251 A CSD joining T2S will pay a one-off joining fee in the amount of 25% of the annual fee that this  
252 CSD will pay to T2S, calculated on the basis of the fee paid in the first full year of T2S operation  
253 of the CSD in question. The fee will be calculated and charged one year after the CSD will have  
254 started its operations in T2S.

### 255 **5.10 Exit Management**

256 If a CSD terminates the T2S Framework Agreement for convenience, the Eurosystem will  
257 invoice the CSD at cost for all planning, co-ordination and execution of exit activities that go  
258 beyond normal operational support. This will also be the case if a CSD decides to exit because  
259 the relevant non-euro area NCB no longer outsources its currency.

260 If a CSD has terminated the Framework Agreement for cause, the Eurosystem will provide the  
261 support for exit activities free of charge.

### 262 **5.11 External Examiner**

263 In accordance with Article 23.7 of the Currency Participation Agreement, the non-euro NCB  
264 and/or its auditors shall have the right to propose special examinations to be conducted by the



# Currency Participation Agreement

## Schedule 7 – Pricing

---

265 External Examiner directly to the Governing Council provided that the non-euro NCB bears the  
266 costs associated with such special examinations.

267 If a regular or special examination is required because of a severe incident or a material and  
268 ongoing problem having disrupted the proper functioning of the T2S Platform or the provision of  
269 T2S Services, as specified in Article 23.5 of the Currency Participation Agreement, the total cost  
270 charged by the External Examiner shall be borne by the Eurosystem.

# CURRENCY PARTICIPATION AGREEMENT

## SCHEDULE 8 GOVERNANCE

Schedule 8 – Governance

---

**Table of contents**

**Preamble..... 1**

**1 The decision-making process..... 3**

1.1 T2S Governance Bodies..... 3

1.2 Decision-making on Change Requests..... 4

1.3 Decision-making on relevant matters other than Change Requests ..... 8

**2 Additional Governance arrangements ..... 9**

2.1 Prioritisation..... 9

2.2 Changes driven by Legal and Regulatory Requirements ..... 10

2.3 Transparency ..... 11

2.4 Technical groups supporting the T2S Governance Bodies ..... 11

**Annex 1 - Mandate of the NECSG ..... 1**

1 Preamble.....**Error! Bookmark not defined.**

2 Objective .....**Error! Bookmark not defined.**

3 Responsibilities .....**Error! Bookmark not defined.**

4 Composition .....**Error! Bookmark not defined.**

5 Term.....**Error! Bookmark not defined.**

6 Reporting.....**Error! Bookmark not defined.**

7 Working Procedures.....**Error! Bookmark not defined.**

**Annex 2 – Mandate of the Governors’ Forum..... 1**

1 Objective ..... 1

2 Responsibilities ..... 1

3 Right to convene ..... 1

4 Composition ..... 2

5 Term..... 2

6 Endorsement of resolutions ..... 2

7 Working Procedures..... 2

**Schedule 8 – Governance**

---

**Preamble**

This schedule sets out the Governance, i.e. the set of rules and procedures concerning the management of T2S Services, including the related procedures for decision-making and the roles of T2S Stakeholders therein. The Governance applies as of the Agreement Date and shall govern the Development Phase and the Operational Phase of TARGET2-Securities (T2S).

The parties agree that:

(1) The aim of the Governance principles is to provide each T2S Stakeholder with the level of control necessary in further pursuing its commercial and policy objectives and to seek compliance with Legal and Regulatory Requirements. However, the parties agree that since T2S is a multilateral environment, their level of control is necessarily less than if each T2S signatory had its own environment. Levels of control can vary with the objects of control as described in this Agreement. However, T2S is designed and operated so that the Connected NCBs will exercise full control in real time over the Dedicated Cash Accounts in their respective currency in T2S as described in Article [20 (7) and (8)].

(2) Control is necessary to ensure that T2S operates safely and efficiently. Moreover, control shall allow change to be achieved and managed so as to ensure that changes that are proposed by one party/parties can be introduced without unduly affecting the other party/parties.

(3) In order to achieve the necessary balance of control, it is very important that transparency is ensured and that all T2S Stakeholders are closely involved in the Governance of T2S. It is essential to ensure that T2S meets the evolving needs of the market in a consensual way. Transparency shall assure the T2S Stakeholders that final decisions will not be taken before their positions are considered by the relevant T2S Governance Body and by the other T2S Stakeholders. For this reason, technical and policy documents, such as the User Requirements Document, the Economic Impact Analysis and the T2S Governance arrangements were extensively discussed with market participants and published on the T2S's website. The Eurosystem intends to continue doing so.

(4) The euro area and the Connected NCBs need to maintain control of their respective currencies in T2S. In particular they need to continue to be able to operate the cash accounts they hold for their Dedicated Cash Account Holders, and to be able to safeguard the integrity of their respective currency (which, for the purposes of the CPA, includes the implementation of monetary policy including all central bank credit operations as well as settlement in Central Bank Money in their currency). They also need to maintain or contribute to financial stability in their country and to ensure a level playing field for market participants.

## Schedule 8 – Governance

---

(5) Users, i.e. the customers of CSDs, and ultimately issuers and investors are the eventual beneficiaries of T2S. Their demands have to be appropriately taken into account when further developing T2S functionalities in order to ensure that T2S continues to meet the needs of the market.

On the basis of the above considerations, Section 1 explains the relationship of the different T2S Governance Bodies in the decision-making process. Additional Governance arrangements are outlined in Section 2.

**Schedule 8 – Governance**

---

**1 The decision-making process****1.1 T2S Governance Bodies**

The T2S Governance Bodies are specified in Article [20 (6)] of this Agreement. They are involved in the decision-making process with final decisions being taken by the Governing Council in accordance with Article [20] of this Agreement and in accordance with this Schedule.

The Steering Level consists of the Non-euro Currencies Steering Group (NECSG), the CSD Steering Group (CSG) and the T2S Board. For matters which are referred to the Steering Level in this Agreement and which have not been delegated to the T2S Board by the Governing Council, the Governing Council represents the Eurosystem. Each T2S Governance Body has the possibility to establish substructures, i.e. technical groups (permanent) or task forces (ad-hoc); see also Section 2.4.

The resolutions of the Governors' Forum require the endorsement of the Governing Council and the decision-making bodies of each of the Connected NCBs.

Schedule 8 – Governance

Figure 1: Bodies involved in the T2S Governance

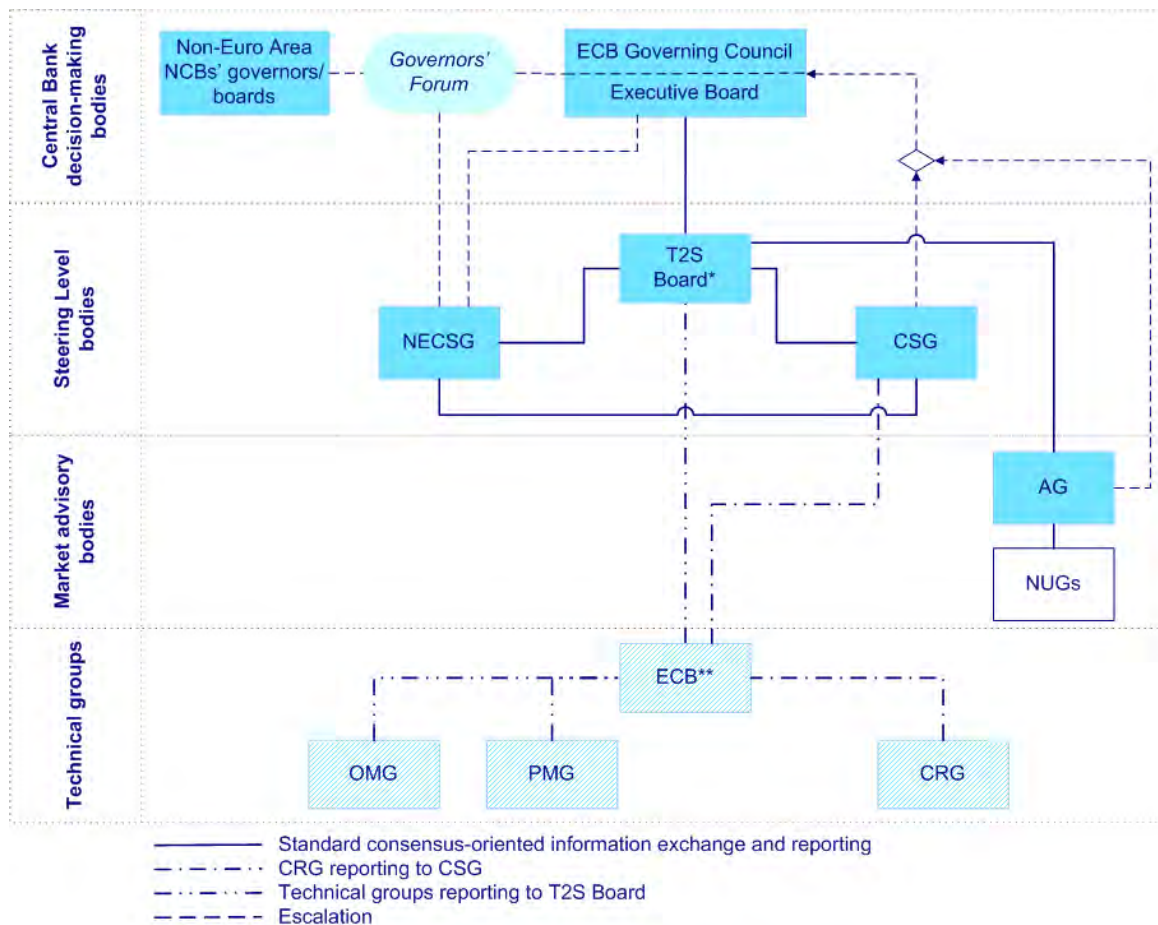

Note: \* The T2S Board is the Eurosystem T2S Governance Body at the Steering Level for matters which have been delegated by the Governing Council. The T2S Board liaises with other Eurosystem internal governance structures for issues of common concern.

\*\* The ECB routes the reporting and the information to the respective addressees.

**1.2 Decision-making on Change Requests**

1. Any individual Participating CSD, User member in the AG, euro area NCB, Connected NCB, the ECB or the 4CB may initiate a Change Request. Changes to Common Components may also be initiated within a TARGET Service<sup>1</sup> other than T2S, by means of introducing a change request in accordance with the governance processes of the respective TARGET Service.
2. The Change Request is prepared by the Change Review Group (CRG) according to the procedures described in Schedule 9 (Change and Release Management). The CRG submits its deliverables to the CSD Steering Group (CSG) via the ECB. The ECB also provides the

<sup>1</sup> The list of TARGET Services is available in the T2S Operational Governance Process Framework, which is listed in the Annex 8 to Schedule 2 as a T2S deliverable.

**Schedule 8 – Governance**

---

CRG deliverables to the T2S Board, the Non-euro Currencies Steering Group (NECSG) and the T2S Advisory Group (AG) and publishes the deliverables on the T2S website. Should any of the before-mentioned T2S Governance Bodies fail to provide its view within a reasonable amount of time, taking into account the urgency of the Change Request, this T2S Governance Body is then assumed to have agreed with the Change Request and the decision-making procedure continues.

3. If the Change Request was related to safeguarding the integrity of the respective currency (which, for the purposes of the CPA, includes the implementation of monetary policy including all central bank credit operations as well as settlement in Central Bank Money in the respective currency) and/or financial stability as part of crisis management measures, transparency could be limited to the contracting T2S Actors (Participating CSDs and Central Banks) upon request of a Central Bank. Such Change Requests shall be made transparent at the latest when the change is taken up in a release.
4. The AG gives its advice on the Change Request within a reasonable amount of time, taking into account the urgency of the Change Request. The advice of the AG is addressed to the T2S Board and it shall be published on the T2S's website.
5. The CSG takes a resolution on the Change Request within a reasonable amount of time, taking into account the urgency of the Change Request. The resolution of the CSG is addressed to the T2S Board and shall be published on the T2S's website.
6. The NECSG takes a resolution within a reasonable amount of time, taking into account the urgency of the Change Request. If the Connected NCB(s) consider at risk the integrity of the respective currency, the financial stability or the level playing field for market participants, such concern shall be included in the resolution of the NECSG. The resolution of the NECSG is addressed to the T2S Board and it shall be published on the T2S's website.
7. A final decision on the Change Request is taken by the Governing Council on the basis of a proposal by the T2S Board within a reasonable amount of time, taking into account the urgency of the Change Request. The T2S Board submits a proposal to the Governing Council after having reached a consensus with the CSG and the NECSG, taking into account the advice of the AG in accordance with paragraph 8.
8. If consensus cannot be achieved based on the stakeholders' initial resolutions, the T2S Board aims at reconciling the different views before the Governing Council takes its final decision:
  - a. The T2S Board coordinates discussions with relevant stakeholder groups in order to find a consensual solution. The T2S Board may ask for a re-assessment of the Change



**Schedule 8 – Governance**

---

Request by the CRG taking into account the views of all relevant stakeholders. Based on the CRG re-assessment, the T2S Board discusses with all relevant stakeholder groups taking into account the respective views and prepares a compromise proposal within a reasonable amount of time, taking into account the urgency of the Change Request. The T2S Board shares this proposal with the CSG, the NECSG and the AG. For issues of key concern, this consensus driven approach to establish a compromise proposal may be a repetitive process. Once consensus is reached within a reasonable amount of time, taking into account the urgency of the Change Request, the AG formally gives its new advice and the CSG and the NECSG take new resolutions on the Change Request.

- b. If such discussions do not lead to consensus, the T2S Board, the CSG or the NECSG may ask for a non-binding external advice except for matters related to safeguarding the integrity of currencies in T2S or to financial stability. The party providing such advice needs to be selected by common agreement of the T2S Board, the CSG and the NECSG and deliver its advice in parallel to the T2S Board, the CSG, the NECSG and the AG. All relevant stakeholder groups review their position on the basis of the non-binding external advice and the T2S Board coordinates discussions with the relevant stakeholder groups in order to find a consensual solution in accordance with paragraph 8a and taking into account paragraph 9 and 10. Within a reasonable amount of time and taking into account the urgency of the Change Request, the AG formally gives its final advice and the CSG and the NECSG take final resolutions on the Change Request before the Governing Council takes the final decision on the basis of a proposal by the T2S Board.
9. If the reconciliation process according to paragraph 8 does not lead to consensus between the Eurosystem and the Connected NCB(s), both Parties have the right to request a review of the issue by the Governors' Forum, in order to find a consensual solution.
10. If no solution for the dispute can be found in the Governors' Forum, the following procedure applies:
  - a. the view of the Eurosystem as owner and operator of T2S prevails. If the dispute was based on the refusal of a Change Request because Connected NCB(s) consider that the measure is inappropriate for reasons linked to their responsibilities in terms of safeguarding the integrity of the respective currency or in relation to financial stability, the Eurosystem would have to justify overruling the refusal either (i) with the need to safeguard general Eurosystem central bank functions (safeguarding the euro, financial stability, no distortion of competition) or (ii) with the need to preserve the integrity of the T2S platform for economic, functional or technical reasons.

## Schedule 8 – Governance

---

- b. the concerned Connected NCB(s) shall have the right to terminate the respective bilateral CPA. The concerned Connected NCB(s) shall have the right to require that they can exit T2S within 24 months after the Governing Council's decision, during which period they shall not be affected by a change they rejected. Connected NCBs shall endeavour to limit the exit period to the shortest time possible.

11. The final decision of the Governing Council is published on the T2S's website.

**Schedule 8 – Governance**

---

**1.3 Decision-making on relevant matters other than Change Requests**

1. Any individual Participating CSD, euro area NCB, Connected NCB, the ECB, the 4CB or User member in the AG may, outside the scope of Change Requests, propose a resolution or, in particular in the case of the AG, an advice concerning relevant matters of T2S<sup>2</sup> to the T2S Board or, in exceptional circumstances, to the Governing Council.
2. In all T2S Governance Bodies the chairperson may decide that the proposal for a resolution or an advice needs first to be analysed by a substructure, i.e. a technical group (permanent) or by a task force (ad-hoc). The T2S Board or, in exceptional circumstances, the Governing Council organises the procedure in such a way that all T2S Governance Bodies are properly consulted within a reasonable amount of time and without duplicating substructures on similar topics. In case of divergence of views between different T2S Governance Bodies, the T2S Board shall aim at reconciling the different views. The CSG or the NECSG can, upon agreement with the T2S Board, ask for a non-binding external advice for relevant matters of T2S<sup>1</sup> except for matters related to safeguarding the integrity of currencies in T2S or to financial stability. The party providing such advice needs to be selected by common agreement of the T2S Board, the CSG and the NECSG and shall deliver its advice in parallel to the T2S Board, the AG, the CSG and the NECSG.
3. A decision on the proposal is taken by the Governing Council or, for matters which have been delegated by the Governing Council, by the T2S Board after consultation of the AG, the CSG and the NECSG within a reasonable amount of time, taking into account the urgency of the matter.
4. The Eurosystem notifies the relevant parties. For Connected NCBs, the following procedure applies. The Eurosystem notifies the decision to the Connected NCB Governors who, in general, have four weeks to object if they consider that the measure is inappropriate for reasons linked to their responsibilities in term of safeguarding the integrity of the respective currency or in relation to financial stability. The relevant procedure, as defined under Section 1.2, paragraphs 9 and 10 above, applies.
5. The decision of the Governing Council or the T2S Board shall be published on the T2S website.

---

<sup>2</sup> Such relevant matters include crisis management, risk issues, operational issues, monitoring the T2S Service (in accordance with the Service Level Agreement), pricing issues, acceptance for testing and go-live.

**Schedule 8 – Governance**

---

**2 Additional Governance arrangements**

In addition to the general Governance procedures outlined above, this section clarifies a number of specific situations.

**2.1 Prioritisation**

The Change Review Group:

- shall assess Change Requests and prepare a list of ranked Change Requests based on the procedures described in Schedule 9 (Change and Release Management).

The Project Managers Group:

- shall prepare a prioritisation proposal for defining the content of a T2S release based on the procedures described in Schedule 9 (Change and Release Management).

The AG:

- shall submit its advice regarding the prioritisation of Change Requests to the T2S Board;

The CSG:

- shall make a resolution addressed to the T2S Board regarding the prioritisation of Change Requests stemming from the Participating CSDs or in relation to the functioning rules of Securities Accounts;
- may prepare a proposal to the T2S Board on the prioritisation of all Change Requests.

The NECSG:

- shall make a resolution addressed to the T2S Board regarding the prioritisation of Change Requests stemming from the Connected NCBs or in relation to the functioning rules of Dedicated Cash Accounts;
- may prepare a proposal to the T2S Board on the prioritisation of all Change Requests.

The T2S Board:

- shall prepare a proposal for the prioritisation of all T2S Stakeholder Change Requests to be submitted to the Governing Council taking into account the views of the AG, the CSG and the NECSG. If the proposals for prioritisation of Change Requests provided by the

## Schedule 8 – Governance

---

T2S Board, the AG, the CSG and the NECSG diverge, the T2S Board shall aim at finding consensus and seeks the views of the AG, the CSG and the NECSG before submitting the final proposal on the prioritisation of Change Requests to the Governing Council.

The Governing Council:

- shall prioritise all T2S Stakeholder Change Requests on the basis of a T2S Board proposal, to which the views obtained from the AG, the CSG and the NECSG are attached.

### 2.2 Changes driven by Legal and Regulatory Requirements

Changes motivated by Legal and Regulatory Requirements shall be dealt with in T2S according to the standard procedure set out in Schedule 9 (Change and Release Management) with high priority, in accordance with the principle that T2S shall support the participating CSDs in complying with oversight, regulatory and supervisory requirements, and following the relevant decision-making process. Such Change Requests have to be initiated by the affected entities.

However, several cases have to be distinguished:

- (a) Changes in European legislation are dealt with as quickly as possible or as required in the legislation. The analysis of the Change Request by the various T2S Governance Bodies mentioned in this note concerns only the modalities of the implementation.
- (b) It is expected that the Participating CSDs and Central Banks inform the T2S Board on any proposed change in national legislation with an impact on T2S as early as reasonably practicable. The relevant Change Requests shall be dealt with according to the standard procedure. The final decision shall be taken by the Governing Council and a potential refusal shall include the reasons why the implementation of the Change Request is not feasible.
- (c) Change Requests resulting from a Relevant Competent Authority request shall follow the standard procedure and the Eurosystem shall involve the AG, the CSG and the NECSG. Should these discussions lead to a disagreement with the Relevant Competent Authority, the Change Request shall be brought to the Governing Council and the Relevant Competent Authority will be invited to submit its written view directly to the Governing Council. The Governing Council would then take due account of the views of the Relevant Competent Authority before making a decision. Should the Governing Council reject the Change Request, it will provide a written explanation of the rationale to the Relevant Competent Authority. The Governing Council can reconsider its decision based on additional

**Schedule 8 – Governance**

---

information provided by the Relevant Competent Authority. When a Change Request resulting from a Relevant Competent Authority request relates to only one market it shall not be in contradiction with the General Principles of T2S and relevant costs shall be borne by the Participating CSDs, subject to the regulatory decision.

- (d) Changes under (b) and (c) above which involve legislation or regulatory requirements in a non-euro area country are discussed in the Governors' Forum, if the Governor of the relevant Connected NCB so requests.

The Eurosystem shall aim at finding solutions to the cases outlined above, including the possibility of optional features to the extent that they are technically viable and within the Lean Scope of T2S.

**2.3 Transparency**

In order to allow a wide range of market participants to remain closely involved in T2S developments, the extensive T2S transparency regime shall be continued and relevant documentation and information shall be made available on the T2S's website. In particular, the Eurosystem's offer of the future updates of the Framework Agreement to all interested CSDs and of the Currency Participation Agreement to all interested non-euro area NCBs shall be made transparent. Furthermore, relevant advice, resolutions and decisions related to changes shall be published. This transparency will allow all T2S Stakeholders to contribute to ongoing T2S discussions and make their views known to relevant T2S Governance Bodies.

**2.4 Technical groups supporting the T2S Governance Bodies**

Each T2S Governance Body has the possibility to establish technical groups, and to dissolve them, to deal with T2S issues that are within its remit. The T2S Board shall make proposals to avoid duplication of substructures on similar topics.

The technical groups shall in particular:

- (a) ensure that T2S and subsequent releases go-live and that CSDs, as well as Central Banks, are duly and timely prepared, including with regard to the relevant aspects of User Testing and Migration;
- (b) review, in line with Schedule 2 (T2S Programme Planning and Monitoring), the CSD and/or Central Bank-relevant planning and programme reporting, including risks and issues;
- (c) assess Change Requests, as defined in Schedule 9 (Change and Release Management);

**Schedule 8 – Governance**

---

- (d) develop and maintain the Manual of Operational Procedures; and
- (e) meet the Eurosystem to review the T2S service performance against the SLA.

The technical groups shall report to the relevant T2S Governance Bodies. The technical groups have the possibility to exchange relevant information directly among themselves. They organise their work in an efficient manner to fulfil their mandates, including the possible creation of their own substructures.

At the time of the signature of the Currency Participation Agreement, the following groups have been considered as technical groups:

- (a) **PMG: Project Managers Group**, established by the Steering Level and consisting of project managers of Participating CSDs, euro area NCBs, non-euro area NCBs, the ECB and 4CB. The T2S Board shall appoint the chairperson of the PMG on the basis of her/his technical expertise after consultation of the CSG and the NECSG. The PMG reports to the T2S Board and keeps the CSG and the NECSG informed of its work. It needs to ensure that T2S and subsequent releases go live and that CSDs as well as Central Banks are duly and timely prepared. Its name, mandate and need for continuation will be reviewed when all CSDs and Central Banks will have migrated to T2S.
- (b) **CRG: Change Review Group**, established by the Steering Level and consisting of product managers and functional experts of Participating CSDs, euro area NCBs, non-euro area NCBs, the ECB and 4CB. User representatives participate in the CRG as observers. The T2S Board shall appoint the chairperson of the CRG on the basis of her/his technical expertise after consultation of the CSG and the NECSG. The CRG reports to the CSG via the ECB. The ECB disseminates the deliverables of the CRG also to the T2S Board, the AG and the NECSG. It assesses Change Requests as defined in Schedule 9 (Change and Release Management). The CRG and the PMG also need to exchange information regarding the impact of changes on the T2S timeline. The CRG continues the work of the AG Sub-Group on User Requirements Management.
- (c) **OMG: Operations Managers Group**, established by the Steering Level and consisting of operations experts of Participating CSDs, euro area NCBs, non-euro area NCBs, the ECB and 4CB. Representatives of Users which are Directly Connected Parties may participate in the OMG as observers for specific agenda items. The T2S Board shall appoint the chairperson of the OMG on the basis of her/his technical expertise after consultation of the CSG and the NECSG. The OMG reports to the T2S Board and informs the AG, the CSG and the NECSG. It develops and maintains the Manual of Operational Procedures, meets to review the T2S service performance against the SLA and coordinates the management of

## Schedule 8 – Governance

---

operational incidents. The OMG continues the work of the AG Sub-Group on Operational Framework.



**Annex 1 - Mandate of the NECSG****1. Preamble and Objectives**

TARGET2-Securities (T2S) is a multi-currency system for the whole of Europe. The T2S Services that the Eurosystem offers to Central Securities Depositories (CSDs) in Europe allow for the core, neutral and borderless settlement of securities transactions on a Delivery versus Payment basis in Central Bank Money for all participating currencies. This is performed in a single technical platform integrated with Central Banks' Real-Time Gross Settlement systems for all participating currencies. The provision of T2S Services in different currencies is based on the cooperation between Central Banks and the equality of all currencies in T2S.

The ECB's Governing Council and the governing bodies of the non-euro area national central banks that signed the Currency Participation Agreement (CPA) (hereinafter the 'Connected NCBs') have established the Non-euro Currencies Steering Group (NECSG). The NECSG discusses all matters of relevance for Connected NCBs in T2S.

The NECSG supports the decision-making process in T2S, which has a multilateral character, by providing the Eurosystem, to the extent possible, with a common position of the Connected NCBs on matters of relevance for Connected NCBs. The NECSG works within the Governance specified in Schedule 8 of the CPA.

**2. Responsibilities and Tasks**

In the T2S Governance, the NECSG is responsible for articulating and coordinating the views of Connected NCBs. The NECSG may give its advice or agree on a resolution on any issue in relation to T2S, in particular on:

- changes to the CPA and its Schedules, in line with the applicable procedures;
- any topic brought to the ECB Governing Council that has implications for the CPA;
- topics brought to the attention of the ECB Governing Council in relation to changes to T2S;
- changes to the T2S Scope Defining Set of Documents, in line with the applicable procedures specified in the CPA Schedule 8 (Governance) and Schedule 9 (Change and Release Management);
- the prioritisation of Change Requests stemming from Connected NCBs;

## Schedule 8 – Annex 1 – Mandate of the NECSG

---

- disputes between the Eurosystem and non-euro area NCBs upon the invitation of the T2S Board, the ECB Governing Council or the CSD Steering Group;
- any other consultation request of the T2S Board or the ECB Governing Council;
- crisis management;
- risk topics;
- operational topics;
- monitoring the T2S Service (in accordance with the Service Level Agreement);
- pricing topics;
- acceptance for testing and go-live, and
- on any matters of relevance in relation to the CPA.

The outcome of a discussion in the NECSG neither restricts the ability of a Central Bank to safeguard the integrity of its currency (which, for the purposes of the CPA, includes the implementation of monetary policy including all credit operations as well as the settlement in Central Bank Money in the respective currency) nor the control over its respective cash accounts (including the exercise of its rights and duties under the CPA), nor pre-empts the right of the Governor of any of the Connected NCBs to request a meeting of the Governors' Forum.

The NECSG's mandate becomes effective on the Agreement Date and shall be reviewed every three years. The NECSG mandate expires with the replacement of the CPA with a new agreement and/or with the termination of the CPA by the signatories.

### **3. Composition and Term**

The NECSG is composed of senior managers nominated by the respective Governors of all Connected NCBs. The NECSG Chairperson is elected by the members of the NECSG and appoints a very experienced member of staff of any of the Connected NCBs or the ECB as NECSG Secretary. The NECSG Chairperson may designate an alternate to replace the NECSG Secretary in exceptional circumstances.

The NECSG Chairperson may invite the T2S Board Chairperson to attend their discussions as an observer.

The term of the NECSG members begins and ends at the same time as the term of the members of the T2S Board.

## Schedule 8 – Annex 1 – Mandate of the NECSG

---

### 4. Reporting

The NECSG gives its advice and makes resolutions to the T2S Board as the managing body of T2S, upon invitation or on its own initiative. The NECSG may transmit its resolutions directly to the Governors' Forum and/or the ECB Governing Council if it considers that the integrity of the national currencies of Connected NCBs, the General Principles of T2S or other core elements of T2S are at risk. The NECSG may establish its own procedures on the frequency of this reporting, which may vary over time during the validity of the CPA.

### 5. Working Procedures

Detailed working procedures are specified in the 'Rules of Procedure' to be drafted by the NECSG. The T2S Board has the possibility to express a non-binding opinion on the Rules of Procedure before their entry into force.

The NECSG meets upon the invitation of the NECSG Chairperson and as frequently as the NECSG decides. The dates of meetings shall be communicated to NECSG members sufficiently in advance. The agenda of each NECSG meeting is approved at the beginning of the meeting.

In principle, meetings take place at the ECB's premises, however meetings may also be held by means of teleconferencing or be replaced by consultation through written procedure. The ECB provides operational and secretarial support to the NECSG. Meeting documentation will be circulated sufficiently in advance of meetings, i.e. at the latest five T2S Settlement Days prior to a meeting if not agreed otherwise.

The NECSG may invite the T2S Board Chairperson or another T2S Board member to its discussion. The NECSG may request the advice of the CSD Steering Group and/or the T2S Advisory Group.

The NECSG's aim is to adopt resolutions by consensus and to avoid where possible transmitting individual views to the Eurosystem. However each individual member of the NECSG has the right to:

- include an opinion in an NECSG resolution that differs from the view of the other central banks; and

## Schedule 8 – Annex 1 – Mandate of the NECSG

---

- escalate an issue to the Governors' Forum if they consider that a T2S Board decision negatively affects their ability to safeguard the integrity of their respective national currency.

Any NECSG member may propose a resolution. A disagreement between one or more Connected NCBs and the Eurosystem may be escalated from the technical, expert and sub-structure level to the NECSG. The NECSG aims at working in consensus. However, if the NECSG members and the T2S Board Chairperson cannot reach a mutually agreeable solution, the issue is escalated to the T2S Board and ultimately to the Governors' Forum.

### **6. Sub-structures**

The NECSG may establish sub-structures to support its work if considered necessary. It coordinates with the T2S Board who organises work in such a way that all relevant T2S Governance Bodies are properly involved without duplicating sub-structures on similar topics.

### **7. Transparency**

All relevant documentation and information shall be made available in a secure workspace, accessible to all NECSG members. As part of the transparency principle of T2S, NECSG resolutions and advice as well as the NECSG mandate are in general published on ECB website.

**Annex 2 – Mandate of the Governors’ Forum****1 Objective**

The ECB’s Governing Council and the governing bodies of the non-euro area national central banks that signed the Currency Participation Agreement (CPA) (hereinafter the ‘Connected NCBs’) have established the Governors’ Forum. The Governors’ Forum discusses in exceptional circumstances matters of relevance for Connected NCBs in TARGET2-Securities (T2S) that could not be resolved by other bodies. It is the clear objective of the Governor’s Forum to discuss and settle such disputes by agreeing on a common resolution in consensus.

**2 Responsibilities**

The Governor’s Forum deals with all disputes between the Eurosystem and the Connected NCBs arising in relation to the implementation of the CPA and to T2S in non-euro area countries in general when all other methods of reaching a consensus have been exhausted.

Appropriate matters that can be brought to the Governors’ Forum include in particular, but not exclusively:

- issues related to safeguarding the integrity of the non-euro area currency (which, for the purposes of the CPA, includes the implementation of monetary policy including all central bank credit operations as well as the settlement in Central Bank Money in their currency) or financial stability;
- issues related to other legal or regulatory responsibilities of the Connected NCBs;
- issues related to the (potential) termination of a CPA and the subsequent exit management procedure for a Connected NCB.

**3 Right to convene**

The Governors’ Forum meets only in the event that:

- (a) one or several members of the NECSG consider that a decision of the T2S Board negatively affects their ability to safeguard the integrity of their respective currency (which, for the purposes of the CPA, includes the implementation of monetary policy including all credit

## Schedule 8 – Annex 2 – Mandate of the Governors’ Forum

---

operations as well as the settlement in Central Bank Money in their respective currency) or financial stability;

- (b) one or several governors of Connected NCBs wish to discuss any matter that a governor feels appropriate to raise in relation to T2S;
- (c) the Governing Council wishes to consult the Governor’s Forum before taking a decision or to discuss any matter which the Governing Council feels appropriate to raise in relation to T2S.

### **4 Composition**

The Governors’ Forum is composed of the governors of the Connected NCBs that have signed the CPA and an equal number of Governing Council members. The Governors’ Forum is chaired by the President or the Vice-President of the ECB.

### **5 Term**

The Governors’ Forum is established and can be convened as of the Agreement Date until the CPA is terminated or replaced by another contractual arrangement.

### **6 Endorsement of resolutions**

The resolutions of the Governors’ Forum require the endorsement of the Governing Council and the decision-making bodies of each of the Connected NCBs.

### **7 Working Procedures**

The Governors’ Forum meets only upon the request of one or several Connected NCBs and/or the Governing Council and works based on consensus of its members. The Governing Council and the governors of Connected NCBs can agree to have recourse on an ad-hoc basis to expert panels. Such panels assist the Governors’ Forum in finding a compromise solution. This applies in particular to technical issues.

Relevant conclusions are made public on T2S’s website after the endorsement of the Governing Council and the decision-making bodies of each of the Connected NCBs.

The Governors’ Forum is an ad-hoc body and therefore does not require specific rules of procedure. The T2S Board Chairperson acts as secretary to the Governor’s Forum.

# **CURRENCY PARTICIPATION AGREEMENT**

## **SCHEDULE 9**

### **CHANGE AND RELEASE MANAGEMENT**

**Table of contents**

**INTRODUCTION..... 1**

**1. OBJECTIVE..... 2**

**2. SCOPE..... 3**

**3. ENTITIES INVOLVED IN THE CRM PROCESS ..... 5**

**3.1 Technical level ..... 5**

    3.1.1 ECB ..... 5

    3.1.2 4CB..... 5

    3.1.3 Participating CSDs and the Central Banks ..... 6

    3.1.4 Change Review Group (CRG)..... 6

    3.1.5 Project Managers Group (PMG)..... 7

    3.1.6 Operations Managers Group (OMG)..... 7

**3.2 Steering Level ..... 8**

**4. CHANGE MANAGEMENT ..... 9**

**4.1 Categorisation of changes..... 9**

    4.1.1 Type of change according to urgency ..... 9

    4.1.2 Type of change according to beneficiary ..... 9

    4.1.3 Parameters of changes ..... 10

        4.1.3.1. Parameter 1: Legal/business importance ..... 10

        4.1.3.2. Parameter 2: Market implementation efforts..... 11

        4.1.3.3. Parameter 3: Operational/technical impact..... 12

        4.1.3.4. Parameter 4: Financial impact for T2S..... 12

**4.2 Change Management process..... 14**

    4.2.1 Change Request Initiation and Registration..... 14

    4.2.2 Preliminary assessment..... 15

    4.2.3 Authorisation ..... 16



## Schedule 9 – Change and Release Management

---

<b>5. RELEASE MANAGEMENT .....</b>	<b>17</b>
<b>5.1 Release types and frequency .....</b>	<b>17</b>
<b>5.2 Release Management process.....</b>	<b>18</b>
5.2.1 Definition of release .....	18
5.2.2 Release baselining .....	21
5.2.3 Release monitoring .....	21
5.2.4 Implementation .....	22
5.2.4.1. Design, building and configuration .....	22
5.2.4.2. Testing of a new release by the Participating CSDs and the CBs .....	23
5.2.4.3. Roll- out and communication .....	25
5.2.4.4. Delivery – Go-live.....	26
5.2.5 Post implementation review.....	26
<b>Annex 1: Change Request Form.....</b>	<b>1</b>
<b>Annex 2: Change Request Status .....</b>	<b>1</b>

## Schedule 9 – Change and Release Management

---

### Introduction

There will be changes in T2S for a variety of reasons. Due to the fact that these changes need to be translated in a timely and consistent way into functional, legal, operational or technical specifications, with the involvement of (and impact on) all relevant T2S Stakeholders, a proper Change and Release Management process (CRM) must be defined and implemented. In addition, the implementation of any of these changes can risk damaging the service's availability or integrity, and may require changes (or specific monitoring efforts) on the part of entities connected to, or relying on, T2S. The CRM process is thus essential in order to efficiently track and manage changes to T2S and to mitigate the risks associated with these changes.

The definition of a release will follow a demand driven model, meaning that a priority rating is used to establish the order in which the authorised changes should be considered for a particular T2S release, and also taking into consideration the available capacity and the resources for implementing the change.

The CRM process is based on the ITIL (Information Technology Infrastructure Library) framework version 3.0 for IT service management.

**The CRM process will apply before and after T2S Go-Live Date, for all Change Requests (falling within the scope of this document) that are initiated as from the entry into force of the Framework Agreement respectively the Currency Participation Agreement.**

The Eurosystem, the CSDs that have signed the Framework Agreement (FA) ('Participating CSDs') and the non-euro area NCBs that have signed the Currency Participation Agreement (CPA) ('Connected non-euro area NCBs') will be entitled to participate in the CRM process as full members of the technical groups in accordance with the T2S Governance. User representatives participate in the CRG as observers.

Meanwhile, the CSDs and non-euro area NCBs which have not yet entered into an agreement with the Eurosystem by the agreed date will have no right of co-decision in the CRM process until they sign. They will be kept informed about the changes to the T2S Services via T2S communication channels.

## Schedule 9 – Change and Release Management

---

### 1. Objective

The objectives of the CRM process are to:

- Respond to the relevant T2S Stakeholders' changing business requirements while maximising value and minimise the risk of change related incidents;
- Ensure that Change Requests falling within the scope of this document will be managed within the Lean Scope of T2S;
- Ensure that Change Requests are managed in an efficient and controlled manner from the initiation until implementation (recorded and then evaluated, authorized, and that the resulting changes are prioritized, planned, tested, implemented, documented and reviewed in a controlled manner);
- Ensure that Change Requests falling within the scope of this document are communicated to all relevant T2S Stakeholders in accordance with the rules laid down in this Schedule and in Schedule 8 (Governance);
- Agree on the exact T2S release content and plan the successful rollout of a release into the production environment; and
- Ensure that all changes are traceable, secure and that only correct, authorised and tested versions are installed on the T2S production environment.

**Schedule 9 – Change and Release Management**

---

**2. Scope**

The CRM process applies to

- all functional changes which trigger any addition to, deletion from or modification of any item in T2S as defined in the T2S Scope Defining Set of Documents<sup>1</sup>, as well as to changes to these documents, even if they do not have an impact on the T2S functionality;
- the requirements to be fulfilled by NSPs, as laid down in – and taking into account the provisions of – the Licence Agreement, and to the specifications for the Value-added Connectivity Services necessary to implement the Dedicated Link Connections; and
- non-functional changes that affect T2S functionality: they are modifications to the technical platform on which T2S operates, or to the T2S software that do not change the functionality, but their implementation potentially impacts the interoperability and services of CSDs, Central Banks and/or Directly Connected Parties (DCPs). An example for this category of change would be an upgrade of the database software that would require testing by CSDs and Central Banks prior to its implementation in production.

The General Principles of T2S in Section 1.2 of the User Requirements Document cannot be changed as a by-product of another Change Request, but only by a separate Change Request to the General Principles of T2S, which follows the decision-making process in this Schedule and respecting the Eurosystem rights as described in Schedule 8 (Governance). If any other Change Request falling within the scope of this Schedule is not in line with the General Principles of T2S as they read from time to time in the User Requirements Document, the CRG will immediately report such inconsistency to the Steering Level and wait for guidance before continuing the assessment of that Change Request.

Any change subject to the CRM process must be undertaken following the process outlined in this document.

Corrections/changes covered by maintenance activities for fixing errors, mistakes, failures or faults in the software system, which produce an incorrect or unexpected result, or cause it to behave in unintended ways (e.g. fixing errors in coding, design or detailed specification, performing changes to the system caused by an incident/problem) will be managed according to the procedures defined in the Manual of Operational Procedures. However, although these

---

<sup>1</sup> The T2S Scope Defining Set of Documents as defined in the Schedule 1 (Definitions) to the FA and the CPA.

## Schedule 9 – Change and Release Management

---

corrections/changes do not need assessment and authorisation in the context of Change Management process, they follow the Release Management process as described in chapter 5.2.

The following changes are not subject to the CRM process:

- Technical changes to hardware/infrastructure components (i.e. non-functional changes without impact on the T2S functionality) under the control of the Eurosystem that are necessary to sustain the daily operation of T2S in accordance with the Service Levels specified in Schedule 6 (T2S Service Level Agreement). The respective arrangements/procedures for handling these changes are covered in Schedule 6 (T2S Service Level Agreement) and will be detailed in the Manual of Operational Procedures. The operational body/team responsible for managing and implementing the technical changes should liaise closely with the Change Review Group (as defined in section 3.1.3) to ensure a smooth implementation, in particular in case of technical changes that may have an impact on the service delivered (based on the risk assessment);
- Business configuration changes related to market parameters that can be done by the Participating CSDs<sup>2</sup>/ CBs or by the Eurosystem in accordance with the procedures defined in the Manual of Operational Procedures;
- Changes related to non-functional and non-technical documentation e.g. Manual of Operational Procedures, Registration and Connectivity Guides, training materials, etc;
- Updates of the baseline version of T2S Specification and T2S Operational Phase Documents<sup>3</sup>, which follow a Deliverable Change Process. The process and the substructure involved are defined in Schedule 2 Annex 8 (T2S Deliverables list and management process) to the FA and CPA;
- Other changes related to the FA and its annexes, respectively to the CPA and its annexes that will be managed according to the relevant procedure as set out in the FA, respectively the CPA or the relevant annex following the applicable Governance regime.

---

<sup>2</sup> In accordance with the Preamble D of the Framework Agreement, the Participating CSDs shall retain full control of the parameter of its business operations. This applies e.g. for Participating CSDs for setting up the T2S Securities Accounts for their customers including all needed access rules , granting of access privileges, etc Setting up of these parameters and rules should be done according to the best market practices and the relevant regulatory requirements.

<sup>3</sup> T2S Specification and T2S Operational Phase Documents as defined in the Schedule 1 (Definitions) to the FA and the CPA and in the Schedule 2 Annex 8 (T2S Deliverables list and management process).

**Schedule 9 – Change and Release Management**

---

**3. Entities involved in the CRM process**

There are two levels differentiated in the CRM process: a “technical” level and a “Steering” Level. The Participating CSDs and the Central Banks are expected to organise themselves according to these two levels.

**3.1 Technical level****3.1.1 ECB**

The T2S Team of the ECB supports the T2S Board in the CRM process. The roles and responsibilities of the ECB at the different stages of the CRM process are described in the chapters 4.2 and 5.2 of this Schedule. They include inter alia:

- being the entry point for all Change Requests;
- keep a register of all Change Requests;
- manage their processing as described in this document;
- monitor Change Requests during their entire lifecycle, from the initiation until they have reached their end status (i.e. authorization or rejection);
- monitor the release definition and its implementation;
- track progress and issues that may influence decision-making and report them inter alia to the Change Review Group;
- ensure availability of the relevant information to the relevant T2S Stakeholders.

**3.1.2 4CB**

4CB means the Deutsche Bundesbank, the Banco de España, the Banque de France and the Banca d'Italia, collectively, in their capacity as NCBs responsible for building, maintaining and running the T2S Platform based on the respective contractual arrangements and on decisions of the Governing Council. In the context of CRM process, the 4CB is entrusted with different roles and responsibilities as described in the chapters 4.2 and 5.2 of this Schedule. They include inter alia:

- assess the impact stemming from requests for new functionalities or technical

**Schedule 9 – Change and Release Management**

---

enhancements from a technical, functional and operational point of view (feasibility, planning, budget);

- building, configuration and delivery of a release into production;
- propose the time-frame for implementing a change or a release;
- examine the impact on the system security and provide a security impact assessment;

**3.1.3 Participating CSDs and the Central Banks**

The euro area NCBs, the Participating CSDs and the Connected non-euro area NCBs are entitled to participate in the CRM process. Their roles and responsibilities at different stages of the CRM process are described in the chapters 4.2 and 5.2 of this Schedule. They include inter alia:

- act as full members of the Change Review Group (CRG);
- initiate Change Requests on their own or customers' behalf;
- evaluate and monitor Change Requests;
- monitor release definition and implementation;
- test and verify releases;
- involve their respective user communities in the process.

**3.1.4 Change Review Group (CRG)**

With regard to the CRG will be responsible, inter alia for/ in charge of:

- reviewing Change Requests on regular basis, evaluate the information provided in the Change Request and in the assessment (checking its consistency and completeness across all Change Requests) and making proposals for decision making at the Steering Level.
- building and maintaining the scoring mechanism according to which authorised changes will be ranked in view of their implementation in (one of) the next release(s).
- reviewing the content of each release as well as any changes to the agreed release.

As regards the interactions with the Steering Level, the role of the CRG is limited to managing the process from reviewing and evaluating the Change Request to making proposal for its authorisation/rejection as well as the ranking of authorised changes based on the scoring mechanism. The CRG will aim at reaching a common agreement in making a proposal to the

## Schedule 9 – Change and Release Management

---

Steering Level for their decision-making. In case of disagreement, both majority and minority views will be reported to the Steering Level. Once the decision to authorise<sup>4</sup> a change or to define the content of a T2S release has been taken, the decision is binding for the CRG's further work.

The CRG reports to the CSG via the ECB. The ECB also provides the deliverables of the CRG to the T2S Board, the AG and the NECSG.

The CRG will be informed and – to the extent possible and relevant – consulted on technical changes and changes that need to be implemented urgently in order to restore and continue the provision of T2S Services, by the relevant operational groups responsible for handling these changes, in accordance with the procedures defined in the Manual of Operational Procedures.

The CRG will schedule regular meetings, typically every 2 months, but meetings can also be organised more frequently if deemed necessary. The CRG should have face-to-face meetings, however some of the assessment process can be handled in written procedure if this process is accepted by the CRG in advance.

### 3.1.5 Project Managers Group (PMG)

With regard to CRM, inter alia, the PMG will be responsible for:

- preparing the plan for implementation of T2S releases;
- coordinating and monitoring the implementation of T2S releases;
- providing a T2S release scope for approval to the T2S Steering Level based on the list of ranked and assessed change requests from the CRG and the list of ranked and assessed production problems from the OMG;
- reviewing and monitoring the content of each release as well as any changes to the agreed T2S release scope.

### 3.1.6 Operations Managers Group (OMG)

With regard to CRM, inter alia, the OMG will be responsible for:

- assessing and ranking production problems that are pending resolution; and
- reviewing the content of each release as well as any changes to the agreed T2S release scope.

---

<sup>4</sup> The authorisation of a Change Request is covered in the chapter 4.2.3



**Schedule 9 – Change and Release Management**

---

**3.2 Steering Level**

Without prejudice to the role of the Governing Council, the governance bodies at the Steering Level are (i) the T2S Board, (ii) the CSD Steering Group (CSG) and (iii) the Non-euro Currencies Steering Group (NECSG) as defined in the FA and the CPA.

Their roles and responsibilities in the decision-making process of changes and in the prioritisation of Change Requests for defining the content of the next T2S releases, as well as the escalation and dispute resolution procedure in case of disagreement between the Participating CSDs and the Eurosystem, or between the non-euro area NCBs and the Eurosystem are described in the FA, the CPA and Schedule 8 (Governance).

Each governance body at the Steering Level will receive information from the technical groups via the ECB with respect to the CRM process. In the spirit of transparency, this information will also be shared with the Advisory Group in accordance with Schedule 8 (Governance).

## 4. Change management

### 4.1 Categorisation of changes

#### 4.1.1 Type of change according to urgency

According to its level of urgency, a change falls under one of the following categories:

- **Normal changes:** changes that can be planned without time constraints and will go through the CRM process before being implemented into the production environment.
- **Fast-track Changes:** changes that are imposed by Legal and Regulatory Requirements, or by CSG resolutions related to risk management, or changes that are critical for the stability of the T2S Platform or imposed by Central Bank decisions related to safeguarding the currency/-ies or related to crisis management measures to ensure financial stability and that, owing to the time constraints, have to be implemented in a shorter timeframe than normal, which will be decided on an ad-hoc basis. These changes will also go through the CRM process, however, the length of the different process steps will be shortened on an ad-hoc basis, in particular for preliminary and detailed assessment. The CRG may also provide a recommendation to the PMG to coordinate the allocation to a release and the detailed assessment without requiring a preliminary assessment in case of a fast-track change.

#### 4.1.2 Type of change according to beneficiary

Irrespective of the urgency, all changes subject to the CRM process fall into one of the following categories:

- **Common Changes:** any new feature, functionality or service – or any amendment of an existing feature, functionality or service – which is implemented for the benefit of all T2S Actors.
- **Specific Changes:** any new feature, functionality or service – or any amendment of an existing feature, functionality or service – which is not implemented as a Common Change (within the applicable Governance arrangements), but which some Participating CSDs and/or CBs wish to implement, provided that it is compliant with the Lean Scope of T2S, and for which they jointly accept to bear the investment and running costs. In case of Specific Change i) the unauthorised use should be either controlled or monitored

**Schedule 9 – Change and Release Management**

---

(as agreed in the request); ii) in order to avoid any impact on non-supporting Participating CSDs/CBs, the implementation mechanism will be based – if possible – on the approach that the functionality will be made available to all parties, but that those not wishing to use it, are not impacted by the change. iii) If this backward compatibility cannot be ensured, the change can only be authorised upon agreement of each non-supporting CSD/CB. These changes may be triggered by:

- market-specific regulatory, legal, fiscal or market-specific requirements or,
- innovation or improvement considered useful by one or more Participating CSDs or CBs.

**4.1.3 Parameters of changes**

Each change is categorised based on a number of parameters which are used to indicate how important or delicate a change is relative to others changes.

**4.1.3.1. Parameter 1: Legal/business importance**

The importance of a Change Request derives from the business need for a change and should be part of the business justification. From an importance viewpoint, the Change Requests will be classified into one of four categories as defined below:

Category	Definition
Critical	1) A change required by the Eurosystem or by a Connected non-euro area NCB to implement its statutory tasks.  2) A change relating to an area which would - if the change is not implemented - prevent Participating CSDs or CBs or their customers from connecting to and/or using T2S or put the requester in non-compliance (after implementing any work-arounds) with legal, regulatory (including, among others, unacceptable operational risks), or fiscal requirements.  3) Changes to preserve security, systems availability and stability etc.

**Schedule 9 – Change and Release Management**

High	<ol style="list-style-type: none"> <li>1) A change that would offer a significant enhancement and benefits to the T2S Service or the T2S Actors.</li> <li>2) A change to embody agreed harmonisation in T2S where there is a high efficiency benefit.</li> <li>3) A change to significantly improve safety or stability.</li> <li>4) A change to remove major ambiguity or inconsistency in the T2S Scope Defining Set of Documents or the T2S Documentation.</li> </ol>
Medium	<ol style="list-style-type: none"> <li>1) A change with moderate efficiency benefits, but which does not have an important harmonisation dimension.</li> <li>2) A change to improve the usability of the system.</li> <li>3) A change to remove minor ambiguity or inconsistency in the technical and functional documentation.</li> </ol>
Low	<ol style="list-style-type: none"> <li>1) Changes that are “nice to have” and are useful to pad out a release.</li> <li>2) A change to improve clarity of the technical and functional documentation.</li> </ol>

**4.1.3.2. Parameter 2: Market implementation efforts**

Change Requests will be classified into three categories on the basis of the effort required by the market to properly implement and timely absorb the change (i.e. implement the necessary IT changes, adapt the operational procedures, integrate the change into the service offerings, adapt the legal arrangements, etc.)

Category	Definition
High	Changes that require high efforts (a long implementation time and significant resources) on the side of the majority of Participating CSDs, CBs and/or their communities in order for them to be able to implement the change and take full benefit of it.
Medium	Changes that require high efforts (a long implementation time or significant resources) on the side of a minority of Participating CSDs, CBs and/or their communities or medium efforts on the side of the majority of Participating CSDs, CBs and/or their communities in order for them to be able to implement the change and take full benefit of it.
Low	Changes that do not require a long implementation time and any significant resources on the side of Participating CSDs, CBs and their communities in order

**Schedule 9 – Change and Release Management**

	for them to be able to take full benefit of the change
--	--

**4.1.3.3. Parameter 3: Operational/technical impact**

Change Requests will be classified into three categories on the basis of the operational/technical impact if the change is undertaken, i.e. the risk that a change might trigger (some) instability on the T2S Platform. The technical/operational risk of a change is its potential undesirable/unexpected adverse impact on the T2S Platform and on the CSD/CBs.

<b>Category</b>	<b>Definition</b>
High	Changes that have the potential to significantly threaten the Service Level for a significant part of T2S Services or have a significant operational impact on the Participating CSDs, CBs or 4CB, because insufficient mitigating measures can be taken.
Medium	Changes that have the potential to significantly threaten the Service Level for a minor part of T2S Services or have a limited operational impact on the Participating CSDs, CBs or 4CB, because insufficient mitigating measures can be taken.
Low	Changes that are expected not to threaten the Service Level for Participating CSDs or CBs or to have no or insignificant operational impact on the Participating CSDs, CBs or 4CB.

**4.1.3.4. Parameter 4: Financial impact for T2S**

An indication of the impact of the change on the required cost will be provided by the 4CB during the preliminary assessment phase. During the detailed assessment phase, the 4CB will provide the precise investment cost and the annual running cost, including a breakdown on costs for hardware, software and telecommunication.

Change Requests will be classified into five categories on the basis of the cost impact for the implementation of the Change Request.

<b>Category</b>	<b>Financial Impact</b>
<b>Very high</b>	Changes with an investment cost of at least 700 000 EUR
<b>High</b>	Changes with an investment cost of at least 400 000 EUR, but less than 700 000 EUR

**Schedule 9 – Change and Release Management**

---

<b>Medium</b>	Changes with an investment cost of at least 200 000 EUR, but less than 400 000 EUR
<b>Low-medium</b>	Changes with an investment cost of at least 100 000 EUR, but less than 200 000 EUR
<b>Low</b>	Changes with an investment cost of less than 100 000 EUR

**Schedule 9 – Change and Release Management**

---

**4.2 Change Management process**

All changes defined in chapter 2 as falling within the scope of the CRM process are subject to the Change Management (CM) process, the principles of which this section describes. The detailed description of Change Management is documented in the T2S Operational Governance Process Framework, which is listed in the Annex to Schedule 2 of the FA and CPA as a T2S deliverable.

**4.2.1 Change Request Initiation and Registration**

The requester, i.e. Participating CSDs, euro area NCBs, Connected non-euro area NCBs, the ECB or the 4CB, can submit a Change Request to the ECB using the standard form attached in Annex 1 (Change Request Form) and supply key information such as the title of the requested change, its description (changes in the existing features and functionalities, new features and functionalities in T2S), its business motivation (including the legal/regulatory requirement<sup>5</sup>), the urgency of the change, the categorisation of change, the date of the request, etc. Changes to Common Components may also be initiated within a TARGET Service<sup>6</sup> other than T2S by means of introducing a Change Request in accordance with the governance processes of the respective TARGET Service.

Users will always initiate Change Requests indirectly via a Participating CSD or a Central Bank. If this is not successful, Users can propose the initiation of a Change Request as a resolution in the AG. Then upon agreement of the AG, the Change Request is submitted for registration to the ECB who will submit it to the CRG for consideration according to the process described in this chapter.

The requester should clearly state in the description of the change whether the change should be implemented as a Specific Change and whether the unauthorised use of the Specific Change should be prevented or monitored.

Upon receipt the ECB will check the proposed Change Request for formal completeness, collect any missing information from the requester, register the Change Request and confirm its receipt to the requester. The ECB will submit the registered Change Request to the CRG to perform a formal validation. The CRG will check the clarity and completeness of the request, that no complementary changes will be required for its implementation, confirm if the change should be

---

<sup>5</sup> Changes which are motivated by Legal and Regulatory Requirements will be implemented according to chapter 2.2. of Schedule 8 (Governance).

<sup>6</sup> The list of TARGET Services is available in the T2S Operational Governance Process Framework, which is listed in the Annex to Schedule 2 of the FA and CPA as a T2S deliverable.<sup>7</sup> If the Change Request relates to safeguarding the integrity of the respective currency and/or financial stability as part of crisis management measures, transparency could be limited to the contracting T2S Actors upon request of a Central Bank.

## Schedule 9 – Change and Release Management

---

assessed as a Specific Change and/or as a Common Change considering the interest expressed by the other Participating CSDs/ CBs and agree carrying on with the preliminary assessment.

After the CRG's validation, the registered Change Request will be published on the website<sup>7</sup>.

### 4.2.2 Preliminary assessment

Upon the agreement of the CRG to carry out the preliminary assessment, the ECB and the 4CB will perform a preliminary assessment of the proposed Change Request.

The preliminary assessment includes:

- compliance check: whether it falls within the Lean Scope of T2S and does not conflict with another Change Request already submitted;
- functional assessment: how does it affect the functionality as described in the T2S Scope Defining Set of Documents;
- technical assessment: evaluate the technical feasibility and complexity, analyse which domains, business sub-areas or other RTGS and /or CMS systems will be impacted. If necessary, the ECB will cooperate with the relevant non-euro area NCBs and consult the relevant ESCB committees or business areas that are responsible for these Eurosystem services;
- cost assessment: preliminary indication of the impact of the change from a cost perspective (see Parameter 4 in chapter 4.1.3.4 above);
- risk assessment: whether it could trigger instability to the T2S Platform or create performance problems.

The result of the preliminary assessment will be provided by the ECB to the CRG for evaluation, in average 6 weeks and maximum 8 weeks from the agreement of the CRG to carry out the preliminary assessment.

While preliminary assessment is conducted by the ECB and 4CB, the Participating CSDs and CBs will consult their user communities in order to collect information on the change benefits and its impact on the process on the Users' side. This will allow the Users to provide their input and ensure that T2S provides functionality according to the needs of the market.

---

<sup>7</sup> If the Change Request relates to safeguarding the integrity of the respective currency and/or financial stability as part of crisis management measures, transparency could be limited to the contracting T2S Actors upon request of a Central Bank.



**Schedule 9 – Change and Release Management**

---

The CRG will review the outcome of the preliminary assessment and, based on that, provide a recommendation to the Steering Level on whether to authorise or reject the Change Request for inclusion in the ranking procedure. The CRG may also decide to reject a change request after preliminary assessment. This requires the agreement of the requester, in which case the process stops at this stage. The governance bodies at the Steering Level will be informed accordingly. If there is a disagreement from the requester, the issue is escalated to the Steering Level for guidance.

**4.2.3 Authorisation**

The Steering Level authorises or rejects a Change Request in accordance with Schedule 8 (Governance).

The Steering Level may request further evaluation to be conducted by the CRG in order to complement the overall picture. In that case, the impacts of the Change Request will be re-assessed/evaluated as described in chapter 4.2.2.

The final decision on the Change Request may be:

1. To reject the Change Request. If all Participating CSDs and CBs agree on this decision then the process stops at this stage.
2. To authorise the change, as well as its cost recovery method, according to the principles specified in Schedule 7 (Pricing) to the FA and the CPA.

If a change is authorised after a failed dispute resolution in the Governors' Forum, which triggers the termination of the CPA by a non-euro area NCB, the latter has the right to exit T2S within a maximum period of 24 months. During this time and to the extent relevant for the operation of T2S, the non-euro area NCB shall not be affected by the change that triggered their termination. If such a change is imposed by a competent EU authority (i.e. any organization that has regulatory, supervisory or oversight authority over the NCB, or a Connected NCB or a Participating CSD (as required by the context) with cross-border competences), the concerned CB will either make its best endeavours for a quicker exit, or will make the necessary changes in its system so that T2S can implement the change.

The final decision of the Governing Council shall be published on the T2S website. Once authorised, the Change Request will become part of the list of authorised changes, and hence become eligible for implementation in (one of) the next T2S release(s), as explained in chapter 5 on the Release Management process.

**Schedule 9 – Change and Release Management**

---

**5. Release management**

The Release Management (RM) process ensures that all aspects of a change, technical and non-technical, are considered together. The main objective is to deliver, distribute and track one or more changes intended for simultaneous release into the live environment while protecting the integrity of the production environment and its services.

The RM process covers the planning, design, build, configuration and testing of software and hardware to create a set of release components for the production environment. The term “Release” is used to describe a collection of authorised changes which typically consist of enhancements to the T2S Service (i.e. new and/or changed software required and any new or changed hardware needed for the implementation of the changes) and a number of production problem resolutions which are implemented into the production environment.

The goal of the RM process is to ensure that authorised changes and the production problem resolutions that have been agreed as part of a release are secure and traceable, and that only correct, tested and authorised versions are installed into the production environment.

All authorised changes initiated via a Change Management process and the production problem resolutions shall follow the RM process.

**5.1 Release types and frequency**

As of the T2S Go-Live Date the releases can be classified as follows:

- Major release: a release that consists of a set of software changes that affect a significant part of the functionality or that adds substantial new functionality. It may also include the resolution of identified production problems.
- Minor release: a release that encompasses a set of software changes to align with the regularly scheduled update of the ISO 20022 message standard, and, when feasible, to implement a limited number of Change Requests that do not affect a significant part of the functionality. It may also include the resolution of identified production problems.
- Fast-track release: if T2S is confronted with changes that are imposed by Legal and Regulatory Requirements, or by CSG resolutions related to risk management, or changes that are critical for the stability of the T2S Platform or imposed by Central Bank decisions related to safeguarding the currency/-ies or related to crisis management

**Schedule 9 – Change and Release Management**

---

measures to ensure financial stability that cannot be bundled into the next major or minor release due to the time constraints, T2S will have to comply with these requirements, possibly with an additional release, typically containing only the relevant change(s).

- Production problem release: it includes the resolution of identified production problems which cannot be planned for the next major or minor release.

After the T2S Go-Live Date given the active involvement required from various relevant T2S Stakeholders over a certain period of time, the frequency of releases should be minimised in order to be able to manage risks adequately. The optimum frequency of releases should be balanced between the business requirements and the relative impact, risk and cost of the release. Consequently, depending on needs and resource allocation, and without prejudice to the need for any fast-track releases, the Eurosystem can support every year: one major release and - in case of need - one minor release and two production problem releases to resolve those identified production problems which cannot be planned for the next major or minor release.

The Participating CSDs and CBs will have the possibility to monitor the release implementation and to carry out the testing according to the provisions currently described in Schedule 2 (T2S Programme Planning and Monitoring) and 3 (User Testing) to the FA and to the CPA<sup>8</sup>.

**5.2 Release Management process**

This chapter describes the principles of the RM process that applies to all authorised Change Requests and production problem resolutions. The detailed description of Release Management is documented in the T2S Operational Governance Process Framework, which is listed in the Annex to Schedule 2 of the FA and CPA as a T2S deliverable.

**5.2.1 Definition of release**

Based on the lists of authorised changes<sup>9</sup>, the CRG will examine each Change Request in detail and will propose a ranking of these changes based on a scoring mechanism. The detailed description of the process according to which authorised Change Requests will be scored is documented in the Scoring Mechanism, which is listed in the Annex to Schedule 2 of the FA and CPA as a T2S deliverable. Similarly, the OMG will assess and rank all production problems that are pending resolution.

---

<sup>8</sup> The Schedule 2 and 3 will be reviewed and amended after the T2S Go-Live Date release in order to adapt them to the upcoming releases.

<sup>9</sup> Excluding those changes that are frozen during the exit time of a non-euro area NCB (see chapter 4.2.3)

## Schedule 9 – Change and Release Management

---

When conducting the ranking exercise, the CRG should consider the following criteria for Common Changes:

- to ensure a level playing field for all T2S Stakeholders in order to create the highest possible level of satisfaction throughout all T2S Actors/for each type of stakeholders' point of view;
- to consider those changes that bring benefits to the wide majority of the Participating CSDs and CBs; and
- to select those changes which in total serve the interest of all Participating CSDs and CBs;

The CRG should also consider the following criteria for Specific Changes:

- to assess the changes with the aim of balancing the ratio of Common and Specific Changes;
- to select those Specific Changes requested by the Participating CSDs/CBs that do not benefit to a large extent from the Common Changes;
- to increase the priority of Specific Changes in proportion to the time they are waiting to be implemented.

Based on the outcome of the ranking exercises, the PMG will prepare its proposal on the content of the next T2S release.

The ECB and 4CB will prepare detailed assessments for those Change Requests and feasibility assessments for those production problem resolutions included in the T2S release scope proposal of the PMG.

In the detailed assessment the impact of the Change Requests will be evaluated based on the following dimensions:

**Functional impact** – to evaluate the functional consequences of a change, which function(s) it impacts.

**Technical impact** – to evaluate the technical consequences of a change, which module it impacts, the possible impacts on market participants, the complexity of the change, etc.

## Schedule 9 – Change and Release Management

---

**Cost impact** - the assessment of the costs in order to implement the feature. The financial impact will cover the precise investment cost and the annual running costs as well as a breakdown of costs for hardware, software and telecommunication.

**Legal impact** - to evaluate possible impact of the Change Request on the legal construction of T2S and to assess any legal, regulatory or fiscal requirements – particularly on the Participating CSDs and CBs concerned, as well as Intellectual Property Rights-related issues.

**Service Level impact** – to evaluate the impact on the Service Level, including the KPIs agreed with the Participating CSDs, CBs and the other T2S Users.

**Documentation impact** - assessment of the documents that will need to be modified as a result of the Change Request. This can be the URD, GFS, UDFS, GS, GTD, Service Description, the GUI Business Functionality, User Handbooks, SLA, MOP etc.

**Impact on the security of the system** – to examine the impact on the system security and draw the attention to any risk that the Change Request would create.

**Impact on operations** – to highlight any constraint that the Change Request may impose directly or indirectly on IT operations and the possible resulting technical, operational or financial impacts.

The detailed assessment takes a maximum of 10 weeks for the ECB and 4CB after the decision to conduct the detailed assessment has been taken. Each Change Request shall be analysed without undue delay and assuring the quality.

The Eurosystem will provide justification when a Change Request cannot be implemented in a release due to lack of adapting its capacity. The Eurosystem will make best efforts to adapt its capacity to manage the demand for Change Requests as soon as possible.

While defining and approving the scope of a T2S release the relevant bodies may reassess and amend the initial decision to authorise a Change Request.

Based on the outcome of the above process steps following the respective order, the PMG will provide its proposal for the T2S release scope to the T2S Steering Level after consultation with the OMG and CRG.

In case of disagreement in the PMG, the recommendation will draw the attention of each group to the changes relevant for them, outline the reasons for disagreement and if possible suggest a few variants/options with respect to the release content.

## Schedule 9 – Change and Release Management

---

### 5.2.2 Release baselining

In parallel to the release scope definition, the PMG will prepare a detailed service transition plan that will ensure synchronisation with the Participating CSDs'/CBs' planning and presents the intended scope as well as all elements required to execute and monitor the release.

All governance bodies at the Steering Level will review the PMG proposal on the content of the release including the related costs and the service transition plan for approval in accordance with Schedule 8 (Governance). At the end, the Governing Council of the ECB shall prioritise all Change Requests and take a decision on the recommended release scope and service transition plan, on the basis of a T2S Board proposal, to which the views obtained from the CSG, the NECSG and the AG are attached. The information on changes selected for the next T2S release will be published on the website.

### 5.2.3 Release monitoring

Once the service transition plan is finalised and agreed, the PMG will manage and monitor this plan as much in accordance with the provisions of Schedule 2 (T2S Programme Planning and Monitoring) to the FA and the CPA.

In accordance with the roles and responsibilities defined in Schedule 2 (T2S Programme Planning and Monitoring) of the FA and CPA, the following key principles will be followed in the context of release monitoring and reporting:

- A common service transition plan for the release will be maintained based upon clearly identified deliverables and synchronisation points taking into account all the respective constraints and dependencies of the involved parties;
- A regular and close monitoring of the service transition plan for the release, with decisions committing all parties will be undergone based on a comprehensive framework established to manage events that may affect the release deliverables and milestones;
- Relevant documentation and necessary information will be provided by the Eurosystem to all involved parties as background information for supporting release monitoring and reporting;
- Regular meetings will be organised between the Eurosystem and the Participating CSDs/CBs to review and discuss the overall status assessment of the T2S release implementation, to discuss progress and any risks and issues that might jeopardize the release, and recommend mitigation measures/corrective actions;
- A reporting framework will be established by the Eurosystem to inform regularly all

**Schedule 9 – Change and Release Management**

---

involved parties at the various levels of Governance about the status assessment of the release implementation, including the progress against the plan, to provide status assessment of each deliverable relevant for Participating CSDs and CBs and to ensure that the planning issues and risks are identified, discussed and addressed in a timely and appropriate manner.

- A T2S risk and issue management and reporting framework will be established by the Eurosystem to identify, manage and report of risks and issues, affecting the successful delivery of the release;
- A comprehensive framework will be established to allow the Eurosystem to monitor the readiness status of all involved parties to deliver the release into production;
- The Participating CSDs and CBs will ensure their own readiness and coordinate the readiness of their clients to be ready to use the T2S release, i.e. ensuring planning feasibility and monitoring progress.

**5.2.4 Implementation**

The implementation phase starts with the designing, building and configuration through the final testing and verification stages and ends with the actual release into the production environment.

The implementation phase is initiated upon completion of the release baselining process, the principles of which are described in section 5.2.2. The release baselining process is completed at the latest one year before the planned go-live of a minor or major release. The lead time for a production problem resolution release may be less, when agreed.

**5.2.4.1. Design, building and configuration**

Once the approved content of the release is communicated to the 4CB, the latter will be responsible for designing, building and configuring the release. This process includes, inter alia, the following activities:

- Creating a new version of one or more software modules;
- Purchasing equipment or services externally;
- Preparing a hardware modification;
- Updating all relevant documentation or producing new one;

## Schedule 9 – Change and Release Management

---

- Providing training to the Participating CSDs and the CBs, if required<sup>10</sup>.

The following relevant documents are updated by the ECB and 4CB depending on the release scope, and will be provided to the T2S Stakeholders at the points in time as specified in the agreed service transition plan:

- URD, GFS, UDFS, Service Description and GUI Business Functionality, GS, GTD, User handbooks, SLA, MOP

The ECB and 4CB will ensure consistency across all documentation, including legal agreements and operational procedures.

### 5.2.4.2. Testing of a new release by the Participating CSDs and the CBs

The Eurosystem will conduct a Eurosystem Acceptance Testing before the start of User Testing thereby ensuring that the T2S test environments and T2S Platform meet the functional and non-functional requirements (including performance testing - if there is a potential impact on the performance) by the change in order for the users to successfully carry out their User Testing. Once the Eurosystem internal tests are finalised, the Eurosystem confirms the readiness of the T2S testing environments for the T2S User Testing via a release note. The test calendar is communicated to the Participating CSDs and the CBs providing information on the testing activities, the availability of the testing environments and any other relevant information for performing the testing. This test calendar and the test activities will follow as much as possible – and where relevant – the approach defined in Schedule 3 (User Testing).

The Participating CSDs and CBs start testing the new release once all the entry criteria for the User Testing are met. A stability period is envisaged in the pre-production where the system should be tested while running according to the Service Level Agreement. The length of this period will be decided by the PMG on a case-by-case basis. The aim of the User Testing is to ensure that the new T2S release delivers the expected services as described in the User Requirements Document, as well as the functional and non-functional specifications and to guarantee the readiness of the Participating CSDs and CBs and their communities for the migration/operation to/of the new release.

The User Testing activities are performed according to the framework agreed between the Participating CSDs/ CBs and the Eurosystem, which may include a set of user certification tests

---

<sup>10</sup> The Participating CSDs, respectively the CBs are responsible for the providing training to their users. On Participating CSDs/ CBs' request, the Eurosystem should agree on providing trainings for Participating CSDs' respectively CBs' users for topics selected by Participating CSDs/CBs.



## Schedule 9 – Change and Release Management

---

to ensure that T2S Stakeholders are able to use the new or amended functionality correctly. As a matter of fact, the verification of the release is given by the Participating CSDs and CBs once the exit criteria of the verification process have been completed successfully.

The security impact of all proposed changes to the T2S Platform should be assessed prior to delivery into production in order to check that they do not compromise the security of the T2S Platform. In this respect it is noteworthy that security should be planned and integrated from the start of development. This ensures that risk factors are adequately considered in a timely manner and prevents unnecessary costly security measures to be implemented only once the new system is operational.

The testing and release verification process by the Participating CSDs and CBs will typically take up to 3 months (i.e. for a major release).

The following principles will be applied during User Testing phase of a release:

- The scope of release User Testing covers both functional and non-functional testing;
- The preparation of non-functional release user test activities is done jointly by the Eurosystem and the Participating CSDs/CBs;
- The Participating CSDs and CBs shall appoint a CSD respectively CB Test Manager who will be the primary contact point for the Eurosystem for all discussions about user release testing;
- The Eurosystem shall appoint a T2S Test Manager who will ensure proper co-ordination and exchange of information with the CSD's and CB's Test Manager;
- The execution of non-functional release user test activities is the primary responsibility of the Eurosystem;
- The Eurosystem will report to the Participating CSDs/CBs about the results of non-functional release testing;
- User Testing of a new release aims at ensuring compliance of T2S with the T2S Scope Defining Set of Documents;
- The Participating CSDs and CBs define their acceptance tests and agree these with the Eurosystem;
- The Eurosystem defines certification tests and agrees these with the Participating CSDs and CBs;

## Schedule 9 – Change and Release Management

---

- User Testing of a new release is organised in different stages: interoperability testing (both bilateral and multilateral), acceptance testing, community testing and business day testing, based on the concept and the principles laid down in Schedule 3 (User Testing);
- The Participating CSDs and CBs are responsible for the co-ordination of user test activities of a new release with their communities;
- The Eurosystem is responsible for the co-ordination of user test activities of a new release between all T2S Actors, including the organisation of a central repository for test sets, test cases and test scenarios related to the certification tests for T2S User Testing;
- The Eurosystem will support the User Testing activities of a new release through the implementation of incident and problem management procedures as described in the Manual of Operational Procedures;
- The Participating CSDs and CBs shall inform the Eurosystem of any incident they experience during the execution of their user tests of a new release;
- In particular, the Eurosystem shall undertake all necessary corrective measures to resolve all release defects discovered during the User Testing activities of a new release and caused by T2S;
- All decisions related to (un)successful completion of the test stages, as well as the implementation of the release in the production environment will be prepared under the responsibility of the Project Managers Group (PMG) and will be made in accordance with the Governance arrangements laid down in Schedule 8 (Governance).

### 5.2.4.3. Roll- out and communication

The service transition plan drawn up during the preceding phases will be complemented with information about the exact installation process and the agreed implementation activities and delivery of the release into production.

The ECB in collaboration with the 4CB, Participating CSDs and CBs will agree on the rollout planning which includes the following:

- Producing an exact, detailed timetable of events, as well as who will do what i.e. resource plan;
- Producing the release note and communication to the Users;

## Schedule 9 – Change and Release Management

---

- Planning communication;
- Incident management.

All the impacted T2S Stakeholders will be informed on what is planned and how it might affect them. The responsibilities of the interested parties in the implementation of the release will be communicated by the ECB ensuring that everyone is aware of them. This will be accomplished via the release communication/notes.

### **5.2.4.4. Delivery – Go-live**

Bringing the application software release into the production environment is the final step in the Release Management process.

To ensure a smooth roll-out of the release, the checklist and procedures agreed between the Eurosystem, 4CB, the Participating CSDs and CBs need to be followed by all the involved parties.

The Governing Council shall give the formal and final acceptance of the release for the go-live based on the successful completion of the user testing of the new release and after obtaining the views of the CSG, and the NECSG. The release is delivered into the production environment on the agreed date following the agreed procedures.

### **5.2.5 Post implementation review**

A post implementation review will take place periodically in order to evaluate the change/release performance and to verify the effectiveness of the change/release package implementation.

These review meetings will provide an opportunity to assess and review the efficiency and effectiveness of the Change and Release Management Process, as well as to identify any potential improvement to the overall process flow.

Schedule 9 – Annex 1 – Change Request Form

1 **Annex 1: Change Request Form**

General Information	
<b>CR raised by:</b>	<b>Institute:</b>
<b>Change Request title:</b>	<b>Date raised:</b>
	<b>CR ref. no:</b> <i>(to be filled in by the ECB)</i>
<b>Change Request type</b> <i>(Common, Specific, if specific unauthorised use to be controlled or monitored?):</i>  <i>(to be filled in by the requester)</i>	<b>Urgency</b> <i>(Normal, Fast-track)</i>  <i>(to be filled in by the requester)</i>
<b>1. Legal/business importance parameter</b> <b>(C, H, M, L):</b>  <i>(to be filled in by the requester)</i>	<b>2. Market implementation efforts parameter</b> <b>(H, M, L):</b>  <i>(to be filled in by the requester)</i>
<b>3. Operational/Technical risk parameter (H, M, L):</b>  <i>(to be filled in by the requester)</i>	<b>4. Financial impact parameter (H, M, L):</b>  <i>(to be filled in by the 4CB)</i>
<b>Requester Category</b> <i>(CSD, CB, ECB, 4CB)</i>  <i>(to be filled in by the requester)</i>	<b>Status:</b>  <i>(to be filled in by the CRG)</i>
<b>Description of requested change:</b>	
<b>Reason for change and expected benefits/business motivation:</b>	
<b>Submitted annexes / related documents:</b>	

**Schedule 9 – Annex 1 – Change Request Form**

---

**Proposed wording for the Change Request:**

### Annex 2: Change Request Status

At any time, a Change Requests will have one of the following statuses:

**Registered** – The Change Request was registered by the ECB.

**Rejected by Change Review Group** – When the Change Review Group has agreed with the requester that the change should be dropped.

**Under preliminary Assessment** – The ECB/4CB is conducting the preliminary assessment.

**Pending with Change Review Group** – The ECB has submitted the preliminary assessment to the Change Review Group to review it and consult their communities.

**Under Detailed Assessment** – The ECB/4CB is conducting the detailed assessment of the Change Request.

**Being evaluated by the Change Review Group** – The ECB has submitted the detailed assessment to the CRG and they are evaluating it.

**Pending at Steering Level** – The Change Request with the assessment is submitted to the Steering Level for a formal authorisation.

**Authorised at Steering Level** – The Steering Level has authorised the change and it was placed on the official list of changes.

**Rejected at Steering Level** – The Steering Level has rejected the change.

**Allocated to a release** – The change is allocated to a release.

**Under implementation** – The change is under implementation but not yet delivered to test

**Delivered to test** – The change is being tested by the CSDs and CBs

**Verified** – The change was successfully tested and verified by the CSDs and CBs

**Parked** – Change Request is parked for the next T2S release (s).

**Frozen** – The implementation of the change is frozen for max. 24 months due to the exit period of a non-euro area NCB

**Closed** – The Change Request has been implemented in T2S and all relevant documentation has been updated and all other impacted documents have been aligned.

ECB-PUBLIC

# **CURRENCY PARTICIPATION AGREEMENT**

## **SCHEDULE 10**

### **INFORMATION SECURITY**

**Table of contents**

**Introduction ..... 1**

**1 Objective and scope of T2S Information Security ..... 2**

1.1 Objective ..... 2

1.2 Scope ..... 2

**2 General responsibilities of the Contracting Parties ..... 4**

2.1 General responsibilities of the Eurosystem ..... 4

2.2 General responsibilities of the [NCB] ..... 5

**3 The T2S Information Security management framework ..... 6**

3.1 The Information Security Policy for T2S ..... 6

3.2 The T2S Information Security Requirements and Controls ..... 6

3.3 The T2S Information Security risk management process ..... 6

**4 The T2S Information Security risk management process ..... 7**

4.1 Risk management methodology ..... 8

4.1.1 Business impact analysis ..... 8

4.1.2 The T2S Information Security Requirements and Controls ..... 9

4.1.3 The T2S Threat Catalogue ..... 9

4.1.4 The T2S Information Security risk management process ..... 10

4.1.4.1 T2S Information Security management framework review process ..... 11

4.1.4.2 Compliance and risk assessment process ..... 12

4.2 Deliverables to the [NCB] ..... 12

4.2.1 T2S Information Security Risk Evaluation Table ..... 12

4.2.2 T2S Information Security Risk Treatment Plan ..... 13

4.3 Co-operation and escalation procedures ..... 14

4.4 Examples for the Shared Documents ..... 15

4.4.1 T2S Information Security Risk Evaluation Table ..... 15

4.4.2 T2S Information Security Risk Treatment Plan ..... 16



## Schedule 10 – Information Security

---

### 1 Introduction

2 This document aims at presenting the provisions related to the framework to ensure that the  
3 requirements concerning Information Security in T2S are met and kept up-to-date. In addition the  
4 document defines the involvement of the Connected NCB in the Information Security Management  
5 Process, in accordance with the applicable governance arrangements, as well as the Eurosystem's  
6 reporting obligations towards the Connected NCB.

7 The management of Information Security for T2S is largely based on the ISO/IEC standards  
8 27001:2013 and 27002:2013. This Schedule and the related Annexes therefore use the terms and  
9 definitions of these standards, if applicable, and in such case prevail over the terms defined in  
10 Schedule 1. A definition of the relevant terms is included in chapter 2 of Annex 2 (T2S Security  
11 Requirements and Controls) to this Schedule.

12 The document is divided into four chapters, corresponding to the major aspects identified as relevant  
13 for T2S Information Security: i) objective and scope of T2S Information Security; ii) general  
14 responsibilities of the Contracting Parties; iii) the T2S Information Security Management  
15 Framework, and iv) the T2S Information Security Risk Management Process.

16

**17 1 Objective and scope of T2S Information Security****18 1.1 Objective**

19 The objective of T2S Information Security is to protect T2S business processes and its information  
20 from a wide range of threats, whether internal or external, deliberate or accidental, and to minimise  
21 the impact on the continuity of T2S business of any threats, that, despite all measures taken, do  
22 materialise.

23 ISO 27001 defines Information Security as “preservation of confidentiality, integrity and availability  
24 of information; in addition, other properties such as authenticity, accountability, non-repudiation and  
25 reliability can also be involved”<sup>1</sup>.

26 For the avoidance of doubt, it is acknowledged that “*the risk of loss resulting from inadequate or*  
27 *failed internal processes, people and systems or from external events*” (i.e. operational risk as defined  
28 in the report entitled “*International Convergence of Capital Measurement and Capital Standards*”,  
29 published by the Basel Committee on Banking Supervision, June 2006), is covered by the T2S  
30 Information Security Policy, to the extent such risk may have an impact on the confidentiality,  
31 integrity and availability of T2S information. Operational risks that are not covered by the T2S  
32 Information Security Policy are covered in the SLA reports as specified in Schedule 6 (T2S Service  
33 Level Agreement).

**34 1.2 Scope**

35 The scope of the T2S Information Security Schedule covers all arrangements aiming at fulfilling the  
36 T2S Information Security Requirements as specified in Annex 2 (T2S Security Requirements and  
37 Controls) to this Schedule, as well as to the relevant principles to conduct the initial risk analysis  
38 before go-live and all subsequent risk analyses during the production phase. These risk analyses  
39 focus on the proper implementation of the agreed security controls. Furthermore, all reporting  
40 obligations and the activities to keep the T2S Information Security Management Framework up-to-  
41 date are covered by this Schedule as well.

42 The perimeter of the T2S Information Security Management Framework is limited to the T2S  
43 Platform and does not extend to the system(s) in place on the side of the [NCB]. Nevertheless, the

---

<sup>1</sup> ISO 27001:2013 (chapter 3.4)

## Schedule 10 – Information Security

---

44 Eurosystem commits to provide the [NCB] with all information necessary to allow the latter to  
45 perform its own risk management obligations. Network Service Providers are also out of scope for  
46 the T2S Information Security Management Framework managed by the Eurosystem, but the  
47 Eurosystem imposes certain requirements, comparable to those for third party service providers, via  
48 the agreements.

49

**50 2 General responsibilities of the Contracting Parties**

51 As an overarching principle, the Eurosystem and the [NCB] shall co-operate in good faith in order to  
52 allow both parties to fulfil their commitments with respect to Information Security.

**53 2.1 General responsibilities of the Eurosystem**

54 The Eurosystem shall:

55 a) implement the T2S Information Security Management Framework in accordance with this  
56 Schedule, in particular by designing, developing and operating the system with the objective  
57 that each T2S Actor has access to T2S information according to the confidentiality, integrity  
58 and availability requirements described in this Schedule and its Annexes;

59 b) implement a process to manage Information Security in T2S according to the process  
60 described in section 4 of this Schedule:

61 a. regularly reviewing the implementation;

62 b. regularly updating the T2S Security Requirements to keep them in line with technical  
63 developments;

64 c. regularly assess the effectiveness of the process and update it if necessary;

65 c) share the Asset Classification Scheme and Likelihood and Impact Grading Scales used in the  
66 risk management process for information;

67 d) report the results of Information Security reviews to the [NCB] (according to section 4.3 of  
68 this Schedule);

69 e) report Information Security incidents (according to the definition in Annex 2 [T2S Security  
70 Requirements and Controls] to this Schedule) to the Connected NCB;

71 f) report to the Connected NCB newly identified threats or detected gaps that might threaten  
72 T2S Information Security;

## Schedule 10 – Information Security

---

73 g) provide all other relevant information to the Connected NCB to allow the latter to fulfil its  
74 own risk management obligations.

### 75 2.2 General responsibilities of the [NCB]

76 In view of ensuring Information Security for T2S, the Connected NCB shall:

77 a) ensure its own compliance with Information Security requirements according to its internal  
78 standards, regulatory requirements and/or best practices;

79 b) report Information Security incidents (according to the definition in Annex 2 [T2S Security  
80 Requirements and Controls] to this Schedule) to the Eurosystem, if T2S or other T2S Parties  
81 might be impacted by such incidents; and

82 c) report to the Eurosystem newly identified threats or detected gaps that might threaten T2S  
83 Information Security.

84

**85 3 The T2S Information Security management framework**

86 This chapter describes the documents that specify the Eurosystem's commitments in the Information  
87 Security management process.

88 To ensure Information Security the related requirements and implemented measures need to evolve  
89 over time to accommodate for new threats and to adapt to the technical development. All the annexes  
90 will therefore regularly be reviewed and if need be updated according to the arrangements defined in  
91 the Currency Participation Agreement.

**92 3.1 The Information Security Policy for T2S**

93 The Information Security Policy for T2S – attached as Annex 1 (Information Security Policy for  
94 T2S) to this Schedule – is a high-level document embracing, at a generic level, a definition of the  
95 scope of Information Security for T2S, the security policy principles, allocation of responsibilities  
96 and other relevant aspects related to information security in the T2S environment.

97 The Information Security Policy for T2S focuses on the Eurosystem's responsibilities only. Any  
98 Information Security requirements to be applied to the [NCB] are covered in the Service Level  
99 Agreement (SLA).

**100 3.2 The T2S Information Security Requirements and Controls**

101 The purpose of the T2S Security Requirements and Controls – attached as Annex 2 to this Schedule –  
102 is to specify which conditions are to be fulfilled (i.e. the requirements) for establishing information  
103 security for T2S, as well as to indicate how these conditions can be met (i.e. the controls). The  
104 requirements and controls are based directly on ISO standard 27002.

**105 3.3 The T2S Information Security risk management process**

106 The T2S Information Security risk management process – described in chapter 4 of this Schedule –  
107 specifies the approach for managing Information Security for T2S and the related reporting of the  
108 risk situation and planned risk treatment to the [NCB].

**Schedule 10 – Information Security**

---

**109 4 The T2S Information Security risk management process**

110 This chapter outlines the approach to ensure the continuous process of managing Information  
111 Security in T2S. This approach is established under the umbrella of the Information Security Policy  
112 for T2S (Annex 1 to Schedule 10) which embraces at a generic level a definition of the scope of T2S,  
113 the information security policy principles, the allocation of responsibilities and summarises the  
114 information security management domains.

115 The main goal of information security in T2S is to protect T2S information from a wide range of  
116 threats and to minimise the impact of any threats on T2S operations, which, despite all measures  
117 taken, do materialise. In particular, T2S Information Security aims at avoiding any propagation of  
118 Information Security incidents, whether caused endogenously in T2S or by a T2S Actor, to other T2S  
119 Actors. To accomplish this, the T2S risk management process defines two main processes. One  
120 process (i.e. the “review” process) ensures that the T2S Information Security management  
121 framework is kept up to date and effective, while the other process (the “core” process) focuses on  
122 the implementation of this framework and the assessment of any remaining risks.

123 A full risk assessment is performed before the initial go-live of T2S (pre-production security  
124 assessment). Moreover, the process interfaces with the change management and with the incident  
125 management processes to guarantee that the security requirements and controls are in place and that  
126 the risk is continuously monitored and maintained at an appropriate level. In addition to these event-  
127 driven assessments, a time-driven mechanism ensures a complete security compliance checking and  
128 risk assessment every three years also for parts that have not been subject to a change.

129 This chapter is structured as follows:

- 130     ▪ Section 4.1 puts the T2S Information Security risk management process into the perspective  
131       of the complete T2S Information Security management framework;
- 132     ▪ Section 4.2 places emphasis on the information flow exchanged between the Eurosystem and  
133       the [NCB] during the T2S risk assessment process cycle;
- 134     ▪ Section 4.3 describes the co-ordination and escalation process for T2S Information Security  
135       issues and in particular how the [NCB] will be involved in the T2S Information Security  
136       Management Process;
- 137     ▪ Section 4.4 provides examples on how the information shared with the [NCB] is going to be  
138       structured.

## Schedule 10 – Information Security

---

### 139 4.1 Risk management methodology

140 The information security risk management methodology applied by the Eurosystem for T2S is  
141 defined as the series of interlinked components, which provide the common methodological  
142 foundation for delivering, maintaining and governing the information security and related internal  
143 controls for the Eurosystem.

#### 144 4.1.1 Business impact analysis

145 Risk management commonly starts with a criticality assessment of the information system as a whole  
146 determining the business impact for the Eurosystem in relation to the three security aspects:  
147 confidentiality, integrity and availability. Since T2S plays a vital role in the post-trade services chain,  
148 and has cross-system relationships to systems at many CSDs as well as RTGS and collateral  
149 management systems of the Central Banks, it is a systemically important system. Undoubtedly, the  
150 protection needs, in terms of confidentiality, integrity and availability would reach the highest score.  
151 However, even for a highly critical system not all components are of the same criticality level.  
152 Therefore, the Eurosystem categorises the individual assets using the following inventory  
153 classification principles.

154 The rules being that

- 155     ▪ an owner is identified/nominated for each asset;
- 156     ▪ the criticality for each asset is identified taking confidentiality, integrity and availability  
157       aspects into account;
- 158     ▪ all the security requirements and controls (see section 4.1.2) are considered as applicable to  
159       T2S;
- 160     ▪ deviations from this general rule is under the owner<sup>2</sup> responsibility according to the asset  
161       classification's criticality and the applicability of the control;

---

<sup>2</sup> In accordance with ISO 27002, the term 'asset owner' identifies an individual or entity that has approved management responsibility for controlling the production, development, maintenance, use and security of the assets. The term 'owner' does not mean that the person actually has any property rights to the asset, but refers rather to "stewardship" or "custody" of assets, in particular for data.



## Schedule 10 – Information Security

---

162       ▪ deviations must be justified and argued during the compliance checking phase performed by  
163       Information Security experts who have no direct or indirect conflict of interest in the  
164       performance or outcome of this compliance.

165       The list of assets and their categorisation are subject to change. If changes are required to T2S due to  
166       changes in the list of assets (or their categorisation), then these updates will be performed as part of  
167       the Change and Release Management process. On top of that, the asset inventory will be subject to a  
168       complete review every three years.

### 169   **4.1.2   The T2S Information Security Requirements and Controls**

170       The list of controls taken into account for the individual assets is derived from the following different  
171       sources:

- 172       ▪ ISO/IEC standard 27002:2013;
- 173       ▪ URD chapter 18;
- 174       ▪ Experience from the previous version of the requirements.

175       When compiling this list, all controls from all listed sources were taken into account. Only those  
176       controls that are obviously not applicable to T2S have been dropped from these inputs.

177       By coordinating this effort with the work done for Target2, the Eurosystem ensures that a common  
178       approach for these two core systems is followed to ensure an appropriate high level of information  
179       security for all two interconnected systems.

### 180   **4.1.3   The T2S Threat Catalogue**

181       The T2S Threat Catalogue listing all threats that have been considered for T2S is compiled out of  
182       input taken from the Information Security Forum.

183       The Eurosystem consolidated the input by differentiating between threats and root causes, which in  
184       itself are not a threat but can allow several threats to become imminent.

185       The T2S Threat Catalogue provides information on relevant threats to the system (internal or  
186       external/accidental or deliberate) and serves as the basis for the identification of the impact, the  
187       appropriate security controls and (later) evaluation of potential residual risks.

## Schedule 10 – Information Security

---

188 The purpose of the T2S Threat Catalogue is twofold; it helps to identify all potential threats to T2S  
189 without overlooking any and to ensure that all threats are addressed properly by mapping the security  
190 requirements and controls to the threats they address.

### 191 4.1.4 The T2S Information Security risk management process

192 Information Security risk management for T2S is based on two main processes:

- 193     ▪ The T2S Information Security management framework review process ensures that the T2S  
194 Information Security management framework continues to adequately address the risks, as  
195 they change over time by ensuring a timely update and approval of documents. The T2S  
196 Information Security management framework review process consists in identifying new and  
197 changed threats deriving from system changes and new business requirements, incidents and  
198 security developments, as well as Legal and Regulatory Requirements. In addition to this  
199 continuous, event driven process, the Eurosystem will review all documents of the T2S  
200 Information Security management framework on a yearly basis.
  
- 201     ▪ The compliance and risk assessment process is used to assess the overall T2S Information  
202 Security risk situation. This includes the security compliance check to identify deviations  
203 from the T2S Information Security Requirements and Controls as well as their assessment  
204 and reporting to the CSDs and NCBs. The process applied to the whole T2S scope is  
205 triggered every three years, the first before the go-live of T2S (the pre-production security  
206 assessment). In between these full verifications, any changes to T2S or any security related  
207 incident will trigger a partial verification for the relevant parts.

Schedule 10 – Information Security

208

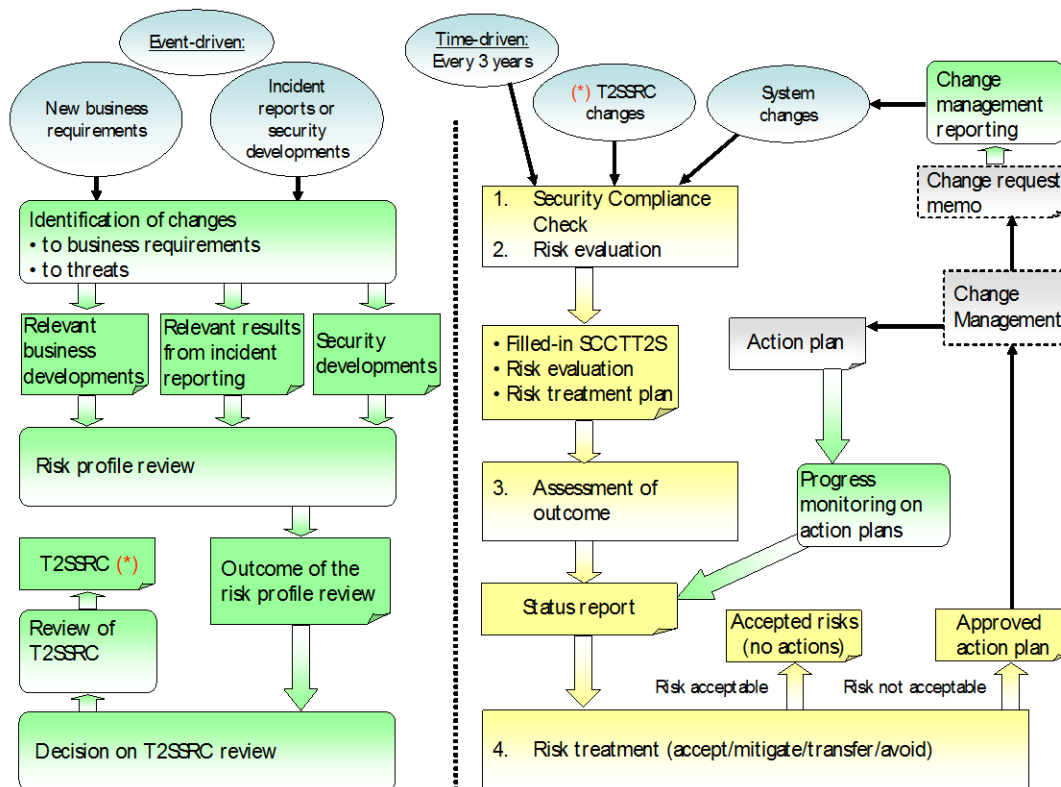

209

210 Figure 1: The two risk management processes and their interaction

211 4.1.4.1 T2S Information Security management framework review process

212 The T2S Information Security management framework review process ensures that the T2S  
 213 Information Security management framework continues to adequately address the risks that T2S is  
 214 exposed, as they change over time. The findings resulting from change requests, incidents and  
 215 security developments provides the Eurosystem with information on which to base a sound  
 216 decision on whether the relevant documents, i.e. the Information Security Policy for T2S, the T2S Threat  
 217 Catalogue and the T2S Security Requirements and Controls, should be updated.

218 In addition to this continuous, event driven process, the Eurosystem will review all documents of the  
 219 T2S Information Security management framework on a yearly basis.

220 If the need for an update is identified, an updated version of the documents is proposed to the  
 221 relevant governance body (as defined in Schedule 8 [Governance]) for approval.

**Schedule 10 – Information Security**

---

**222 4.1.4.2 Compliance and risk assessment process**

223 The compliance and risk assessment is a multi-step process to assess the overall risk situation.

224 In a first step (security compliance check), it takes the defined security requirements and controls and  
225 performs a compliance check by validating the completeness and effectiveness of the actual  
226 implementation of these controls within the scope of T2S.

227 In a second step (risk assessment), all threats addressed by non-compliant controls are assessed  
228 (based on grading scales) concerning likelihood of the risk materialising and its associated impact.

229 In a third step, the risk situation of T2S concerning each threat is determined by aggregating the  
230 results of the individual assessments for those controls that are relevant for this threat into an overall  
231 likelihood and potential impact. The result is represented using a grading scale.

232 In a fourth step, the Eurosystem will make a proposal for the treatment of all identified risks based on  
233 their potential impact on the Eurosystem as provider of the T2S Services. Available options to treat  
234 risks are acceptance, avoidance, mitigation or transfer of risks.

235 In a final step, for all risks that cannot be or are not accepted, actions plans for avoiding, mitigating  
236 or transferring the risks will be defined and implemented (T2S Information Security Risk Treatment  
237 Plan – see section 4.2.2).

**238 4.2 Deliverables to the [NCB]**

239 The Eurosystem drives the process described in section 4.1. However, the assessment of the risk  
240 impacts can only be based on the impact on T2S and/or the Eurosystem. This section therefore  
241 focuses on the information the Eurosystem will share with the [NCB] and their options to use this as  
242 input to their own business risk assessment processes in order to meet their regulatory requirements  
243 and to get evidence that the security requirements are addressed properly by the Eurosystem.

**244 4.2.1 T2S Information Security Risk Evaluation Table**

245 The ‘T2S Information Security Risk Evaluation Table’ (ISRET) is generated as part of the risk  
246 assessment. It provides the likelihood for each threat for which not all the relevant controls are  
247 implemented and effective, as well as the impact of the threat, taking into account the non-compliant  
248 controls. The ISRET includes the following information:

## Schedule 10 – Information Security

---

- 249 1. ID: Threat identification number
- 250 2. Threat: Threat description (from the Threat Catalogue)
- 251 3. Current likelihood (based on a likelihood grading scale)
- 252 4. Likelihood explanation: explanation of the likelihood scoring
- 253 5. Current impact (based on an impact grading scale)
- 254 6. Impact explanation: explanation of the impact scoring
- 255 7. Risk Treatment Plan ID: reference to the appropriate treatment plan mitigating the risk, as
- 256 described in the T2S Information Security Risk Treatment Plan (see section 4.2.2)

257 Based on this ISRET, the [NCB] has the necessary information to evaluate its own business risk.

258 Section 4.4.1 shows the template and an example of this table.

259 The Eurosystem will share with the [NCB] the ISRET whenever it is updated, but at least on a yearly

260 basis.

### 261 4.2.2 T2S Information Security Risk Treatment Plan

262 Together with each ISRET, the Eurosystem will share the proposal for the ‘T2S Information Security

263 Risk Treatment Plan’ (ISRTP).

264 This plan proposes a treatment (i.e. a mitigation measure or acceptance) for all the risks listed in the

265 ISRET.

266 The ISRTP includes the following information:

- 267 1. Risk Treatment Plan ID: Risk Treatment Plan identification
- 268 2. Proposed treatment: information on the planned safeguard measures or proposal to accept
- 269 the risk together with an explanation why it is recommended to accept the risk
- 270 3. Current likelihood of residual risk: likelihood of the residual risk before the implementation
- 271 of the plan (as it appears in the ISRET)

## Schedule 10 – Information Security

---

- 272 4. Likelihood of residual risk after fix: likelihood of the residual risk after the implementation  
273 of the safeguard measures
- 274 5. Current impact of residual risk: impact of the residual risk before the implementation of the  
275 plan (as it appears in the ISRET)
- 276 6. Impact of residual risk after fix: impact of the residual risk after the implementation of the  
277 safeguard measures
- 278 7. Planned implementation date: a deadline by when these measures will be implemented
- 279 8. Status: Progress of the action plan implementation (not started, in progress, closed)  
280 including the date

281 Mitigation measures that imply a functional change to T2S will be processed according to Schedule 9  
282 (Change and Release Management Procedure), while mitigation measures that imply a non-  
283 functional change will be processed according to Schedule 6 (Service Level Agreement – Annex 1  
284 [Management of non-functional changes]). Should the [NCB] see the need for additional mitigation  
285 measures, they can as well raise change requests to implement these measures in T2S.

286 Those risks appearing in subsequent ISRTPs that require follow-up are consolidated in a single  
287 Action Plan in order to monitor whether the action plans are delivered on time. Progress monitoring  
288 on the action plans will be delivered to the [NCB] at least on an annual basis, and whenever there is  
289 an update to the plan or a change of status of a risk treatment (e.g. it is successfully implemented).

### 290 4.3 Co-operation and escalation procedures

291 The Eurosystem shall set up a multilateral co-ordination substructure, in accordance with the T2S  
292 governance, for the coordination and monitoring of the T2S Information Security risk management  
293 activities. This substructure shall meet on a regular basis and shall consist of a limited number of  
294 representatives from the Eurosystem, 4CB, CSDs that have signed the Framework Agreement and  
295 Connected NCBs.

296 The role of the substructure in charge of T2S Information Security Risk management shall be to:

- 297 ■ Coordinate and review T2S Information Security Risk management activities;
- 298 ■ Monitor the implementation of the ISRTP;

## Schedule 10 – Information Security

---

- 299       ▪ Review the ISRET;
- 300       ▪ Discuss issues raised by the members of the substructure, including Information Security  
301       issues emerging outside the scope T2S Information Security;
- 302       ▪ Prepare communications related to Information Security risks to the various T2S  
303       Stakeholders and the public at large.

304   If a new information security risk is identified, or if an existing information security risk obtains a  
305   higher likelihood or impact score, the Eurosystem will communicate such changes to the [NCB] in  
306   accordance with the incident response times specified in Schedule 6 (T2S Service Level Agreement).

307   Upon reception of such communication, or if another information security issue requires urgent  
308   attention:

- 309       ▪ The [NCB] may request a conference call with the Eurosystem, at the latest during the next  
310       business day, or at its earliest convenience;
- 311       ▪ The issue shall be discussed during the conference call;
- 312       ▪ The Eurosystem shall summarize the outcome of the conference call and distribute it to the  
313       members of the substructure in charge of Information Security risk management.

314   In case no agreement can be reached in the substructure, each party shall be entitled to escalate the  
315   problem to the Project Managers Group (PMG), where the situation shall be discussed and rapidly  
316   assessed.

317   If a mutually agreeable solution cannot be found in the PMG, then the general T2S escalation process  
318   shall apply whereby the issue is escalated to the T2S Steering Level in order to receive guidance to  
319   resolve the issue. The escalation process shall be in accordance with the general T2S governance  
320   arrangements, as specified in the Schedule 8 (Governance).

321   Ultimately there shall be recourse to the dispute resolution process as described in the provisions of  
322   the relevant Articles in the core Currency Participation Agreement.

### 323   **4.4 Examples for the Shared Documents**

#### 324   **4.4.1 T2S Information Security Risk Evaluation Table**

Schedule 10 – Information Security

325 Example of the T2S Information Security Risk Evaluation Table that the Eurosystem will share with  
 326 the [NCB].

327

ID	Threat	Risk Likelihood Score	Risk Likelihood Explanation	Risk Impact Score	Risk Impact Explanation	Risk Treatment Plan ID
23	Loss of historical information	3		2		RTP #1
28	External staff dependency	1		3		RTP #2
88	Eavesdropping	2		1		RTP #3
93	Intentional security loopholes	2		2		No additional measure can be applied efficiently

328 **4.4.2 T2S Information Security Risk Treatment Plan**

329 Example for the Risk Treatment Plan the Eurosystem will propose to the [NCB].

Risk Treatment Plan ID	Description of Planned Actions / Proposal to accept the risk	Current Likelihood <sup>3</sup>	Likelihood after fix <sup>4</sup>	Current Impact <sup>5</sup>	Impact after fix <sup>6</sup>	Planned Implementation Date	Status
RTP #1	Description of Risk Treatment Plan #1	3	3	2	1	Planned date for RTP#1	Ongoing
RTP #2	Description of Risk Treatment Plan #2	1	1	3	2	Planned date for RTP#2	Not started due to XXX
RTP #3	Description of Risk Treatment Plan #3	2	1	1	1	Planned date for RTP#3	Not started

330

<sup>3</sup> This column provides for each threat, its likelihood for materializing before the action plan implementation

<sup>4</sup> This column provides the likelihood of materialising for each threat influenced by the action plan (after the action plan implementation)

<sup>5</sup> This column provides the impact of each threat before the action plan implementation

<sup>6</sup> This column provides the impact of each threat after the action plan implementation



# **CURRENCY PARTICIPATION AGREEMENT**

## **ANNEX 1 TO SCHEDULE 10 INFORMATION SECURITY POLICY FOR T2S**

**Table of contents**

<b>1.</b>	<b>Information Security management</b>	<b>2</b>
<b>2.</b>	<b>Purpose of the T2S Information Security Policy</b>	<b>3</b>
<b>3.</b>	<b>Objective</b>	<b>4</b>
<b>4.</b>	<b>Scope of the T2S Information Security Policy</b>	<b>5</b>
<b>5.</b>	<b>Management domains of Information Security</b>	<b>7</b>
5.1	Organization of Information Security	7
5.2	Human resources security	7
5.3	Asset management	7
5.4	Access control	8
5.5	Physical and environmental security	8
5.6	Communications and operations management	8
5.7	Information systems acquisition, development and maintenance	8
5.8	Information Security incident management	9
5.9	Information Security aspects of business continuity management	9
5.10	Compliance	9
<b>6.</b>	<b>Responsibilities for Information Security management in T2S</b>	<b>10</b>
6.1	The Eurosystem	10
6.1.1	<i>Governing Council of the ECB</i>	<i>10</i>
6.2	External stakeholders	10
6.2.1	<i>Central Banks</i>	<i>10</i>
6.2.2	<i>Central Securities Depositories (CSDs)</i>	<i>11</i>
6.2.3	<i>Third Party service providers</i>	<i>11</i>

**INFORMATION SECURITY POLICY FOR T2S**

*T2S is a service to support Central Securities Depositories (CSDs) by providing core, borderless and neutral settlement of securities transactions. The objective is to achieve harmonised and commoditised Delivery-versus-Payment settlement in Central Bank Money in substantially all securities in Europe.*

*Through its direct cross-system relationship with RTGS systems and collateral management systems, a T2S security failure might have systemic implications at a global scale. T2S is a critical IT platform supporting systemically important systems and services and should consequently be designed and operated with a high degree of security and operational reliability. Hence information security is a vital and integral part of T2S.*

*The main objective of information security is to protect T2S information from a wide range of threats and to minimise the impact of any threats on the continuity of T2S operations, which, despite all measures taken, do materialise. In particular, T2S Information Security aims at avoiding any propagation of Information Security incidents, whether caused endogenously in T2S or by a T2S Actor, to other T2S Actors.*

*Any non-compliance with the security objectives defined in the present policy note may have serious business, financial and/or reputational consequences for the Eurosystem.*

**1. Information Security management**

Information Security management shall mean the continuous process of identifying potential threats, verifying whether security controls are comprehensive and effective and minimising or addressing security risks in line with a pre-defined risk tolerance.

Security controls selected to reduce the risk situation must be understandable, effective and appropriate from a cost-benefit perspective. In this respect the task of Information Security management is to find an adequate balance between expenditure on controls and the business harm likely to result from security failures.

Information Security is achieved by implementing suitable security controls. In this context it is important to note that Information Security is not only based on technical solutions. The organisational framework is equally important.

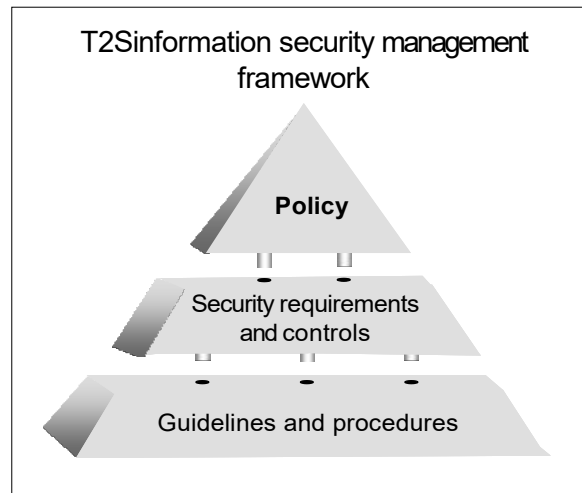

In order to meet these basic principles a comprehensive T2S risk management framework has been developed. This framework has a hierarchical, three-layer structure ranging from a high-level policy to operational procedures. The first layer comprises an Information Security Policy for T2S (i.e. the present document, in the following referred to as *'the policy'*), which embraces at a generic level the security principles and further relevant aspects related to information security management. In the second layer, the T2S Security Requirements and Controls are specified. In the third layer, the T2S Information Security risk management manual describes in detail the risk management processes.

26

**27 2. Purpose of the T2S Information Security Policy**

28 The policy<sup>1</sup> represents the first layer of a comprehensive T2S Information Security management  
29 framework. It is a high-level document embracing, at a generic level, a definition of the scope of  
30 T2S, the security policy principles, allocation of responsibilities and other relevant aspects related  
31 to Information Security in the T2S environment.

32 By approving the policy, the Eurosystem, in its role as owner of T2S, sets a clear direction and  
33 demonstrates its support for and commitment to Information Security. Moreover, the importance  
34 and value of T2S and its processing resources, both human and technical, are being  
35 acknowledged.

36

---

<sup>1</sup> The policy for T2S takes into account the Cyber Resilience report (November 2014) published by BIS CPMI (Bank for International Settlement, Committee on Payment and Market Infrastructure), the ISO/IEC standard 27002:2013 and the ESCB information systems security policy .

### 37 3. Objective

38 The main objective of Information Security is to protect T2S business processes and its  
39 information from a wide range of threats, whether internal or external, deliberate or accidental,  
40 and to minimise the impact on the continuity of T2S business of any threats that, despite all  
41 measures taken, do materialise.

42 ISO 27001 defines Information Security as “preservation of confidentiality, integrity and  
43 availability of information; in addition, other properties such as authenticity, accountability, non-  
44 repudiation and reliability can also be involved”.

45 The terms “confidentiality”, “integrity” and “availability” are then further specified as follows:<sup>2</sup>

- 46     ▪ **Confidentiality:** the property that the asset information is not made available or  
47       disclosed to unauthorized individuals, entities, or processes;
- 48     ▪ **Integrity:** the property of safeguarding the accuracy and completeness of information  
49       assets;
- 50     ▪ **Availability:** the property of the asset information being accessible and usable upon  
51       demand by an authorized individual, entity, or process.

52 Any non-compliance with these objectives might prevent the Eurosystem from meeting its  
53 statutory business goals and/or have serious financial and/or reputational consequences. Through  
54 its direct cross-system relationship with RTGS systems and collateral management systems, a  
55 T2S security failure might, in the worst case, even have systemic risk implications at a global  
56 scale.

57 *In order to meet the key objectives an effective Information Security management framework*  
58 *shall be in place.*

59

---

<sup>2</sup> Definitions based on ISO/IEC standard 27001:2013.

Schedule 10 – Annex 1 – Information security policy for T2S

---

**60 4. Scope of the T2S Information Security Policy**

61 The scope of this policy comprises all assets (including human resources) needed to develop,  
62 implement, maintain and operate T2S. T2S can in principle be subdivided into the following four  
63 main layers:

- 64 1. The *infrastructure* layer, consisting of all hardware components (including interfaces),  
65 required for the development, implementation, maintenance and operation of T2S, even if  
66 these components are used, in whole or in part, for the provision of IT services outside the  
67 T2S context.<sup>3</sup>
- 68 2. The *application* layer consisting of all software components necessary to develop,  
69 implement, maintain and operate T2S. The software component essentially consists of “the”  
70 T2S application, which is subdivided into six functional domains: Interface, Static Data  
71 Management, Settlement, Life Cycle Management and Matching, Liquidity Management  
72 and, SQRA<sup>4</sup>.
- 73 3. The *data* layer consisting of all configuration data, as well as static and transactional data  
74 necessary to run T2S.
- 75 4. The *operational* layer, consisting of all procedures to be applied by and between all relevant  
76 stakeholders in order to run and complete the T2S business day in a sound and safe manner.

77 The smooth operation of T2S as a whole relies to some extent on secure and resilient services  
78 provided by entities which are outside the T2S boundaries. These are:

- 79 ▪ Central Securities Depositories (CSDs).
- 80 ▪ Central Banks allowing their currency to be settled in T2S (through the connection with  
81 their RTGS and, where relevant, collateral management systems);
- 82 ▪ Third Party service providers (such as Network Service Providers), although the  
83 agreements between the Eurosystem and Third Party service providers are subject to the

---

<sup>3</sup> It is important to note that, in accordance with the ECB Governing Council’s decision of 8 March 2007, “*the T2S service will be developed internally within the Eurosystem and operated on the TARGET2 platform in order to exploit synergies with TARGET2 to the fullest extent*”. Because of this so-called “T2S on TARGET2” concept T2S infrastructure assets will exploit full benefits from the information security features already in place for TARGET2.

<sup>4</sup> Statistics, Queries, Reports and legal Archiving

## Schedule 10 – Annex 1 – Information security policy for T2S

---

84 requirements specified in section 15 Supplier relationships of Annex 2 to Schedule 10  
85 (Information Security);

86 The ultimate responsibility to apply this policy to all T2S assets rests with the Eurosystem (as  
87 defined in chapter 6.1). For the assets under the control of external stakeholders (as defined in  
88 chapter 6.2) specific arrangements apply, which are established, implemented and maintained  
89 under their full responsibility (without prejudice to any minimum requirements agreed between  
90 these external stakeholders and the Eurosystem).

91



**92 5. Management domains of Information Security**

93 In the following sections the management domains of Information Security are presented. These  
94 represent at a high level the security requirements that shall be implemented in T2S in order to  
95 preserve confidentiality, integrity and availability.<sup>5</sup> The specific control objectives and the  
96 security controls that shall be implemented to meet these objectives are specified in the “T2S  
97 Security Requirements and Controls” document (Annex 2 of Schedule 10).

**98 5.1 Information security policies**

99 In order to provide management direction and support for information security in accordance  
100 with business requirements and relevant laws and regulations, a set of policies and processes for  
101 information security shall be defined, approved and communicated to the relevant parties.

**102 5.2 Organization of Information Security**

103 In order to ensure that Information Security is adequately managed an organisational framework  
104 shall be established to address Information Security related issues in a comprehensive and  
105 effective manner.

**106 5.3 Human resources security**

107 Personnel (including external party staff) shall be informed about their Information Security  
108 responsibilities, made aware about security rules and procedures and their obligation to adhere to  
109 them.

**110 5.4 Asset management**

111 All T2S information assets shall be identified, classified and prioritised in order to indicate the  
112 required level of protection. The responsibilities for maintaining these assets shall be clearly  
113 assigned to ensure that information assets receive an appropriate level of protection.

---

<sup>5</sup> They are aligned with the high-level security requirements defined in the T2S user requirements (Chapter 18) approved by the Governing Council in July 2008.

**Schedule 10 – Annex 1 – Information security policy for T2S**

---

**114 5.5 Access control**

115 Information shall be protected against unauthorised access. Access to information, information  
116 processing facilities and business processes shall be granted and controlled on the basis of  
117 business and security requirements according to the “need-to-know” principle.

**118 5.6 Cryptography**

119 In order to ensure proper and effective use of cryptography to protect the confidentiality,  
120 authenticity and/or integrity of information, a policy on the use, protection and lifecycle of  
121 cryptographic keys shall be developed and implemented.

**122 5.7 Physical and environmental security**

123 Critical and sensitive information processing facilities shall be housed in secure areas physically  
124 protected to prevent unauthorised access to business premises, damage or compromise of  
125 information assets, interruption to business activities and theft.

**126 5.8 Operations security**

127 Responsibilities shall be clearly allocated and procedures for the management and operation of  
128 T2S information processing facilities established in order to ensure the correct and secure  
129 operation.

**130 5.9 Communications security**

131 In order to ensure the protection of information in networks and its supporting information  
132 processing facilities and maintaining the security of information transferred within an  
133 organization and with any external entity, networks and network services shall be documented,  
134 managed and controlled to protect information in systems and applications.

135 Formal transfer policies, procedures, controls and agreements between the organization and  
136 external parties shall be in place to protect the transfer of information through the use of all types  
137 of communication facilities. Physical or logical segregation of networks shall be implemented.

**138 5.10 Systems acquisition, development and maintenance**

139 Security requirements shall be identified and agreed prior to the development of or changes to  
140 T2S. Adequate security controls shall be in place to prevent loss, modification or misuse of  
141 information in applications systems.

**Schedule 10 – Annex 1 – Information security policy for T2S**

---

**142 5.11 Supplier relationships**

143 In order to ensure the protection of the organization's assets that are accessible by suppliers, an  
144 information security policy shall be developed and integrated within the supplier agreement.  
145 Monitoring and regular reviews of the supplier agreements shall be organised taking into account  
146 the criticality of the business supported.

**147 5.12 Information Security incident management**

148 Effective Information Security incident management procedures shall be in place to ensure that  
149 security events and weaknesses associated with T2S are communicated in a manner allowing  
150 timely corrective actions to be taken.

**151 5.13 Information Security aspects of business continuity management**

152 A business continuity management programme shall be implemented to ensure that necessary  
153 steps are taken to identify the potential impact of security failures on the business, maintain  
154 viable recovery strategies and plans, and ensure continuity of services through training,  
155 exercising, maintenance and review.

**156 5.14 Compliance**

157 All relevant statutory, regulatory and contractual requirements applicable to the T2S shall be  
158 identified, documented and compliance with these arrangements shall be checked in order to  
159 avoid a breach of any criminal or civil law.

160 CSDs outsource a critical part of their business operations to T2S. Hence it shall be ensured that  
161 T2S is operated in compliance with the jurisdiction of the countries where the CSDs are located.

162 Tools and measures to ensure auditability shall be implemented.

163

**164 6. Responsibilities for Information Security management in T2S**

165 Information Security management is a key element of any sound governance structure. ,

166 The common governance structure of T2S comprises a number of different stakeholders whose  
167 roles and responsibilities with respect to information security are outlined in the following. In  
168 this regard, these stakeholders are either the Eurosystem or external entities (namely, the non-  
169 euro NCBs, the Central Securities Depositories and Third Party service providers).

**170 6.1 The Eurosystem****171 6.1.1 Governing Council of the ECB**

172 The TS2 Platform is fully owned and operated by the Eurosystem [see T2S user requirements -  
173 Principle 1]. The Eurosystem is responsible for safeguarding the public function of T2S and has  
174 consequently the ultimate responsibility for deciding on the general security policy and  
175 framework for T2S Information Security management (in accordance with the User  
176 Requirements), and the definition of the risk tolerance.

177 In accordance with ISO 27002, the term ‘asset owner’ identifies an individual or entity that has  
178 approved management responsibility for controlling the production, development, maintenance,  
179 use and security of the assets.<sup>6</sup> Consequently, and without prejudice to the provisions of section  
180 4.3 of Schedule 10 (Information Security), the Eurosystem is also responsible for defining and  
181 implementing an effective organisational framework to address Information Security issues, and  
182 for the acceptance of remaining risks. Furthermore it is responsible for verifying that all  
183 requirements specified in the Information Security policy for T2S are fulfilled in T2S.

**184 6.2 External stakeholders****185 6.2.1 Central Banks**

186 Central Banks operating national infrastructure used as interface to the T2S and providers of cash  
187 accounts are directly responsible for ensuring that Information Security is properly addressed,

---

<sup>6</sup> The term ‘owner’ does not mean that the person actually has any property rights to the asset, but refers rather to “stewardship” or “custody” of assets, in particular for data.

**Schedule 10 – Annex 1 – Information security policy for T2S**

---

188 security controls are effective, and their personnel adhere to their internal security rules and  
189 procedures.

**190 6.2.2 Central Securities Depositories (CSDs)**

191 From an Information Security perspective the roles and responsibilities of CSDs are twofold.

192 First, an operational failure at a CSD could have a significant adverse effect on the smooth  
193 functioning of T2S. Consequently it shall be the responsibility of the CSD to ensure that their  
194 internal systems (incl. interfaces) are operated with a high degree of security and operational  
195 reliability. The relevant provisions must be addressed in the corresponding Service Level  
196 Agreement (SLA).

197 Second, CSDs are subject to a regulatory framework. In this respect CSDs shall seek assurance  
198 that T2S is providing settlement services in a secure and robust manner in compliance with  
199 applicable regulatory arrangements. To the extent that an evolution in regulatory arrangements  
200 has an impact on the T2S Platform, on the T2S Scope Defining Set of Documents, or on the T2S  
201 Specifications, these should be managed through the Change Management procedure laid down  
202 in Schedule 9.

**203 6.2.3 Third Party service providers**

204 Bound by contract Third Party service providers shall implement appropriate measures designed  
205 to protect against risks that could potentially result in substantial harm in terms of confidentiality,  
206 integrity and availability to any T2S services. The relevant provisions must be addressed in the  
207 contract.

# **CURRENCY PARTICIPATION AGREEMENT**

## **ANNEX 2 TO SCHEDULE 10**

### **SECURITY REQUIREMENTS AND CONTROLS**

**Table of contents**

<b>1. Introduction</b>	<b>7</b>
<b>2. Definitions</b>	<b>9</b>
2.1 Definitions	<b>Error! Bookmark not defined.</b>
<b>3. Structure of the security requirements and controls</b>	<b>14</b>
<b>4. Security requirements and controls</b>	<b>15</b>
<b>5. Information security policies</b>	<b>15</b>
5.1 Management direction for information security	15
5.1.1 Policies for information security	15
5.1.2 Review of the policies for information security	15
<b>6. Organization of information security</b>	<b>16</b>
6.1 Internal organization	16
6.1.1 Information security roles and responsibilities	16
6.1.2 Segregation of duties	16
6.1.3 Contact with authorities	17
6.1.4 Contact with special interest groups	17
6.1.5 Information security in project management	17
6.2 Mobile devices and teleworking	17
6.2.1 Mobile device policy	17
6.2.2 Teleworking	17
<b>7. Human resource security</b>	<b>18</b>
7.1 Prior to employment	18
7.1.1 Screening	18
7.1.2 Terms and conditions of employment	18
7.2 During employment	18
7.2.1 Management responsibilities	18
7.2.2 Information security awareness, education and training	18
7.2.3 Disciplinary process	19
7.3 Termination and change of employment	19
7.3.1 Termination or change of employment responsibilities	19
<b>8. Asset management</b>	<b>19</b>
8.1 Responsibility for assets	19

**Schedule 10 – Annex 2 – Security requirements and controls**

---

8.1.1	Inventory of assets	19
8.1.2	Ownership of assets	20
8.1.3	Acceptable use of assets	20
8.1.4	Return of assets	20
8.2	Information classification	20
8.2.1	Classification of information	20
8.2.2	Labelling of information	21
8.2.3	Handling of assets	21
8.3	Media handling	21
8.3.1	Management of removable media	21
8.3.2	Disposal of media	21
8.3.3	Physical media transfer	22
<b>9.</b>	<b>Access control</b>	<b>22</b>
9.1	Business requirements of access control	22
9.1.1	Access control policy	22
9.1.2	Access to networks and network services	22
9.2	User access management	23
9.2.1	User registration and de-registration	23
9.2.2	User access provisioning	23
9.2.3	Management of privileged access rights	23
9.2.4	Management of secret authentication information of users	24
9.2.5	Review of user access rights	24
9.2.6	Removal or adjustment of access rights	24
9.3	User responsibilities	24
9.3.1	Use of secret authentication information	25
9.4	System and application access control	25
9.4.1	Information access restriction	25
9.4.2	Secure log-on procedures	25
9.4.3	Password management system	25
9.4.4	Use of privileged utility programs	26
9.4.5	Access control to program source code	26
<b>10.</b>	<b>Cryptography</b>	<b>26</b>
10.1	Cryptographic controls	26
10.1.1	Policy on the use of cryptographic controls	26
10.1.2	Key management	26



## Schedule 10 – Annex 2 – Security requirements and controls

---

<b>11. Physical and environment security</b>	<b>26</b>
11.1 Secure areas	27
11.1.1 Physical security perimeter	27
11.1.2 Physical entry controls	27
11.1.3 Securing offices, rooms and facilities	27
11.1.4 Protecting against external and environmental threats	27
11.1.5 Working in secure areas	27
11.1.6 Delivery and loading areas	28
11.2 Equipment	28
11.2.1 Equipment siting and protection	28
11.2.2 Supporting utilities	28
11.2.3 Cabling security	28
11.2.4 Equipment maintenance	28
11.2.5 Removal of assets	29
11.2.6 Security of equipment and assets off-premises	29
11.2.7 Secure disposal or re-use of equipment	29
11.2.8 Unattended user equipment	29
11.2.9 Clear desk and clear screen policy	29
<b>12. Operations security</b>	<b>29</b>
12.1 Operational procedures and responsibilities	29
12.1.1 Documented operating procedures	30
12.1.2 Change management	30
12.1.3 Capacity management	30
12.1.4 Separation of development, testing and operational environments	30
12.2 Protection from malware	30
12.2.1 Controls against malware	30
12.3 Backup	31
12.3.1 Information backup	31
12.4 Logging and monitoring	31
12.4.1 Event logging	31
12.4.2 Protection of log information	32
12.4.3 Administrator and operator logs	32
12.4.4 Clock synchronisation	32
12.5 Control of operational software	32
12.5.1 Installation of software on operational systems	32

## Schedule 10 – Annex 2 – Security requirements and controls

---

12.6	Technical vulnerability management	33
12.6.1	Management of technical vulnerabilities	33
12.6.2	Restrictions on software installation	33
12.7	Information systems audit considerations	33
12.7.1	Information systems audit controls	33
<b>13.</b>	<b>Communications security</b>	<b>33</b>
13.1	Network security management	33
13.1.1	Network controls	33
13.1.2	Security of network services	34
13.1.3	Segregation in networks	34
13.2	Information transfer	34
13.2.1	Information transfer policies and procedures	34
13.2.2	Agreements on information transfer	34
13.2.3	Electronic messaging	35
13.2.4	Confidentiality or non-disclosure agreements	35
<b>14.</b>	<b>System acquisition, development and maintenance</b>	<b>35</b>
14.1	Security requirements of information systems	35
14.1.1	Information security requirements analysis and specification	35
14.1.2	Securing application services on public networks	35
14.1.3	Protecting application services transactions	35
14.2	Security in development and support processes	36
14.2.1	Secure development policy	36
14.2.2	System change control procedures	36
14.2.3	Technical review of applications after operating platform changes	36
14.2.4	Restrictions on changes to software packages	36
14.2.5	Secure system engineering principles	37
14.2.6	Secure development environment	37
14.2.7	Outsourced development	38
14.2.8	System security testing	38
14.2.9	System acceptance testing	38
14.3	Test data	38
14.3.1	Protection of test data	38
<b>15.</b>	<b>Supplier relationships</b>	<b>38</b>
15.1	Information security in supplier relationships	39
15.1.1	Information security policy for supplier relationships	39

**Schedule 10 – Annex 2 – Security requirements and controls**

---

15.1.2	Addressing security within supplier agreements	39
15.1.3	Information and communication technology supply chain	39
15.2	Supplier service delivery management	39
15.2.1	Monitoring and review of supplier services	39
15.2.2	Managing changes to supplier services	39
<b>16.</b>	<b>Information security incident management</b>	<b>40</b>
16.1	Management of information security incidents and improvements	40
16.1.1	Responsibilities and procedures	40
16.1.2	Reporting information security events	40
16.1.3	Reporting information security weaknesses	40
16.1.4	Assessment of and decision on information security events	40
16.1.5	Response to information security incidents	41
16.1.6	Learning from information security incidents	41
16.1.7	Collection of evidence	41
<b>17.</b>	<b>Information security aspects of business continuity management</b>	<b>41</b>
17.1	Information security continuity	41
17.1.1	Planning information security continuity	41
17.1.2	Implementing information security continuity	41
17.1.3	Verify, review and evaluate information security continuity	42
17.2	Redundancies	42
17.2.1	Availability of information processing facilities	42
<b>18.</b>	<b>Compliance</b>	<b>42</b>
18.1	Compliance with legal and contractual requirements	42
18.1.1	Identification of applicable legislation and contractual requirements	43
18.1.2	Intellectual property rights	43
18.1.3	Protection of records	43
18.1.4	Privacy and protection of personally identifiable information	43
18.1.5	Regulation of cryptographic controls	43
18.2	Information security reviews	43
18.2.1	Independent review of information security	44
18.2.2	Compliance with security policies and standards	44
18.2.3	Technical compliance review	44

**1 1. Introduction**

2 The basis for the security requirements and controls are the International Standards ISO/IEC  
 3 27001 (Second edition 2013-10-01) and ISO/IEC 27002 (Second Edition 2013-10-01 + technical  
 4 corrigendum 1 published on 2014-09-15) together referred to respectively as ISO/IEC  
 5 27001:2013 and ISO/IEC 27002:2013.

6 The purpose of the security requirements and controls (SRC) is to specify the security  
 7 requirements as laid down in the relevant information security policy for T2S.

8 The SRC are derived from the Information security policy and represent the *second layer* of the  
 9 comprehensive risk management framework depicted in the following exhibit.

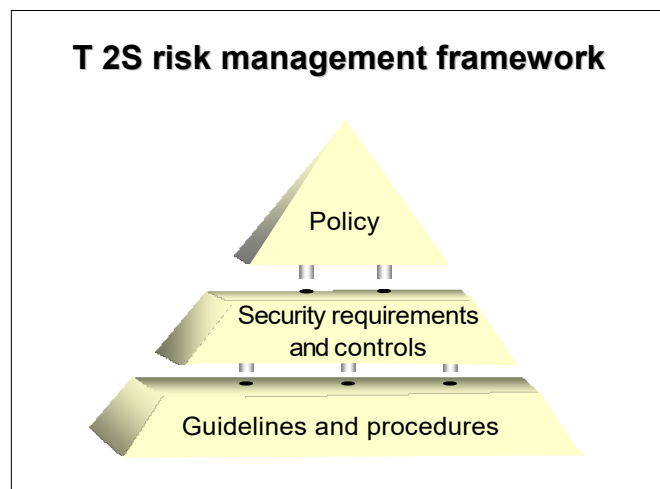

**Exhibit 1:** T2S risk management framework

10

11 As a general rule, the implementation of the security controls specified in this document is  
 12 mandatory<sup>1</sup>. However, it might be that due to specific technical and/or environmental  
 13 circumstances (e. g. contradicting national legislation) the application of a particular security  
 14 control is not feasible. If this was the case, it will have to be justified in the context of the security  
 15 assessment, more specifically when the compliance of T2S with the SRC is checked, why it is not  
 16 possible to implement this particular security control. The associated residual risk must then be  
 17 accepted by the system owner.

18 In addition to the requirements specified in the present document, good information systems  
 19 security measures and routines corresponding to best practice (such as ESCB/Eurosystem  
 20 relevant policies and guidelines, ISF, NIST, SANS, the German BSI) should be applied.

---

<sup>1</sup> In the following document the words ‘must’ and ‘should’ are used for better readability but have the same meaning in the sense as being mandatory.

## Schedule 10 – Annex 2 – Security requirements and controls

---

21 **All** security requirements and controls included in this document are specified from a business  
22 perspective and have to be implemented by the service provider (4CB) responsible for designing,  
23 building and operating T2S.

24

25 **2. Definitions**

26 For the purpose of this document, the terms listed in the following table have the meaning as  
 27 specified in that table. If not superseded by a more specific definition, terms and definitions apply  
 28 as specified in ISO/IEC 27000: 2016. If this document is part of a set of documents, the same  
 29 terms defined in such other documents do – for the purpose of this document – not affect their  
 30 meaning as specified in the following table.

Term	Definition
Asset	Anything that has a value to the organisation, like for instance <b>information</b> (e.g. databases, data files), <b>software</b> (e.g. system software, application software), <b>physical assets</b> (e.g. processors, tapes, power supply), <b>services</b> (e.g. computing services, heating, air-conditioning) and <b>people</b> (e.g. users, consultants).
Customer	Customer is defined as any entity that has a business relationship with the Eurosystem under the Framework Agreement or under the Currency Participation Agreement.
Cyber resilience	An FMI’s ability to anticipate, withstand, contain and rapidly recover from a cyber-attack.  [CPMI Guidance on cyber resilience for financial market infrastructures June 2016]

**Schedule 10 – Annex 2 – Security requirements and controls**

Term	Definition
<p>Disaster [Major operational disruption]</p>	<p>A high-impact disruption of normal business operations affecting a large metropolitan or geographic area and the adjacent communities that are economically integrated with it. In addition to impeding the normal operation of financial industry participants and other commercial organisations, major operational disruptions typically affect the physical infrastructure.</p> <p>Disasters (Major operational disruptions) can result from a wide range of events, such as earthquakes, hurricanes and other weather-related events, biological incidents (e.g. epidemics), terrorist attacks, and other intentional or accidental acts that cause widespread damage to the physical infrastructure. The most significant in terms of their impact are referred to as extreme events, which typically cause the destruction of, or severe damage to, physical infrastructure and facilities, the loss or inaccessibility of personnel, and restricted access to the affected area.</p> <p>[Taken from the BIS “High level principles for business continuity” published in August 2006]</p>
<p>External Party</p>	<p>Any entity different from the Eurosystem (including the Central Banks it is composed of) and its Contractual Parties under the Framework Agreement or the Currency Participation Agreement</p>
<p>FMI</p>	<p>Financial Market Infrastructure</p>
<p>Guideline</p>	<p>A description that clarifies what should be done and how, to achieve the objectives set out in the policies [ISO/IEC 13335-1:2004]</p>
<p>Impact</p>	<p>The result of an unwanted incident.</p>
<p>Impact analysis</p>	<p>The process of identifying the threats to the assets and the impact such threats could have, if the threat resulted in a genuine incident. Such analysis should quantify the value of the assets being protected to decide on the appropriate level of safeguards.</p>
<p>Information</p>	<p>The meaning that is currently assigned to data by means of the conventions applied to those data.</p>
<p>Information processing facilities</p>	<p>Any information processing system, service or infrastructure, or the physical locations housing it [ISO/IEC 27000:2016].</p>

**Schedule 10 – Annex 2 – Security requirements and controls**

Term	Definition
Information security	Preservation of confidentiality, integrity and availability of information; in addition, other properties, such as authenticity, accountability, non-repudiation, and reliability can also be involved [ISO/IEC 27000:2016].
Information security event	Identified occurrence of a system, service or network state indicating a possible breach of information security policy or failure of safeguards, or a previously unknown situation that may be security relevant [ISO/IEC 27000:2016].
Information security incident	An information security incident is indicated by a single or a series of unwanted or unexpected information security events that have a significant probability of compromising business operations and threatening information security [ISO/IEC 27000:2016].
Information Security Management System (ISMS)	Systematic approach for establishing, implementing, operating, monitoring, reviewing, maintaining and improving an organization’s information security to achieve business objectives.
Inherent risk	The risk before risk treatment.
Management	Must be understood as “Senior Management”
Organisation	Must be understood as “Service” or “Service providing organisation” (when reference is made to the entity) or to the respective National Central Bank (when reference is made the entity employer’s role or contracting party regarding external staff members).
Policy	Intentions and direction as formally expressed by senior management.
Recovery	Recovery (or recover) refers to the restoration of the processing service and settlement activities after a disruption including the processing of pending payment transactions.
Relevant external party	Must be understood as “Users and external parties”
Remote user	A user establishing a connection from a location outside of the information processing facilities, i.e. crossing the firewalls protecting the service perimeter.
Residual risk	The risk remaining after risk treatment [ISO/IEC 27000:2016].
Risk	The potential that threats will exploit vulnerabilities of an asset or group of assets to cause loss of or damage to the assets.



Schedule 10 – Annex 2 – Security requirements and controls

Term	Definition
Risk analysis	Process to comprehend the nature of risk and to determine the level of risk [ISO/IEC 27000:2016]
Risk assessment	Overall process of risk identification, risk analysis and risk evaluation [ISO/IEC 27000:2016].
Risk evaluation	Process of comparing the results of risk analysis with risk criteria to determine whether the risk and/or its magnitude is acceptable or tolerable [ISO/IEC 27000:2016]
Risk identification	Process of finding, recognising and describing risks [ISO/IEC 27000:2016].
Risk management	<p>Coordinated activities to direct and control an organization with regard to risk. [ISO/IEC 27000:2016].</p> <p><b>Risk management</b> is the ongoing process of <b>risk assessment</b> (evaluation of the impact or system criticality, and the likelihood of loss/damage occurring) leading to the definition of security requirements and the <b>additional mitigation</b> (by safeguards) <b>and/or acceptance of remaining risks.</b></p>
Risk treatment	Process to modify risk [ISO/IEC 27000:2016].
Risk Profile	<p>Having a different risk profile shall mean that the <i>alternate site</i> must be sufficiently remote from, and does not depend on the same <i>physical infrastructure</i> components as the primary business location. This minimises the risk that both could be affected by the same event. For example, the <i>alternate site</i> should be on a different power grid and central telecommunication circuit from the primary business location.</p> <p>[Derived from the BIS “High level principles for business continuity” published in August 2006]</p>
Security assessment	A documented process reflecting the risk management procedure and presenting prevailing status of risks in relation to the security requirements, i.e. remaining risks for the security aspects such as: availability, integrity, confidentiality, authentication, authorisation, auditability and non-repudiation.
Security control	<p>Means of managing risk, including policies, procedures, guidelines, practices or organizational structures, which can be of administrative, technical, management, or legal nature</p> <p><b>NOTE:</b> Security control is also used as a synonym for control, safeguard (measure), or countermeasure.</p>

**Schedule 10 – Annex 2 – Security requirements and controls**

Term	Definition
Security policy	Must be understood as “Information Security Policy”
Security requirements	The types and levels of protection necessary to meet the security of the assets. The security requirements result from the security risks and are addressed by implementing suitable security controls.
Security risk	The potential that a given threat will exploit vulnerabilities of an asset or group of assets to cause loss of or damage to the assets.
Senior management	This is the highest decision making body of the service providing organisation (4CB).
Service	The term “Service” refers to all the T2S services as defined in the T2S Service Description document.
Service providing organisation	This term refers to all parts of the service provider’s (4CB) organisation that are involved in the T2S activities (design, build, test, operate, maintain, support T2S).
Service perimeter	This encompasses all infrastructural and technical components, business/ organisational procedures and rules, human resources that are used to provide the T2S service.
Third party	A company or individual recognized as being independent of the Contractual Parties, and that provides services generally covered by a Service Level Agreement.
Threat	A potential cause of an unwanted incident, which may result in harm to a system or organization [ISO/IEC 27000:2016]
User	An individual that can log into the service with a login name and requests or uses the services provided. For the purpose of this document User only applies to internal stakeholders (users) designing, building, testing (internal), operating (business and technical), maintaining and supporting (business and technical) T2S.
Vulnerability	Weakness of an asset or control that can be exploited by one or more threats [ISO/IEC 27000:2016]

32 **3. Structure of the security requirements and controls**

33 By default, if not otherwise specified in this document, all the controls included in the  
 34 Annex A of ISO 27001: 2013 and in the ISO 27002:2013 are considered mandatory.

35 Chapter 5 through 18 consists of 14 *Information Security Management Domains* which mainly  
 36 serve the purpose of structuring the broad field of information security. On a second layer the  
 37 *Security Requirements* specifying the objectives that should be achieved are defined. Finally on a  
 38 third layer the (benchmark) *Security Controls* are specified.

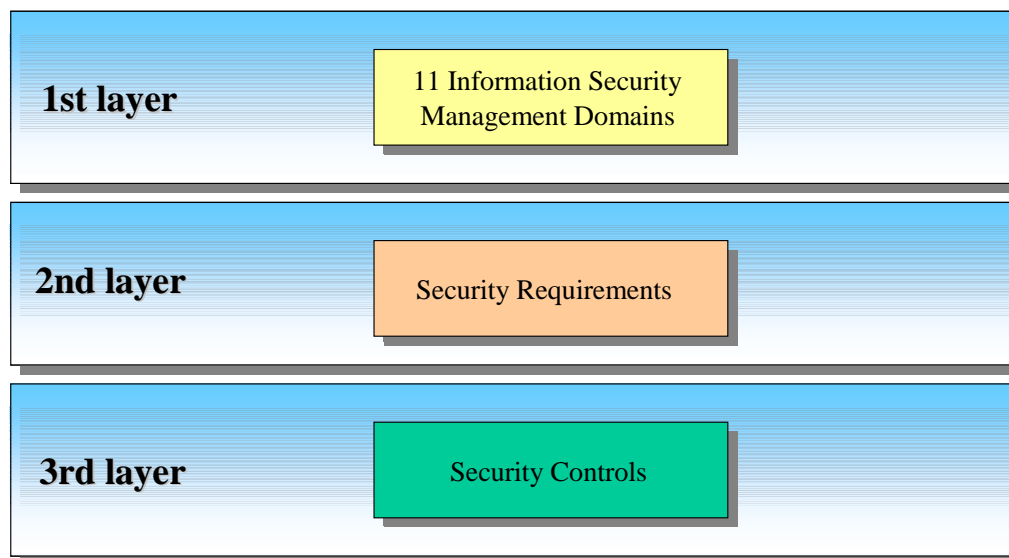

39 **Exhibit 2:** Structure of the security requirements and controls

40 Under each information security management domain the security requirements are specified.  
 41 Each security requirement (ISO 27002:2013 control category) section contains:

- 42 a) a control objective stating what is to be achieved, i.e. the actual security requirement; and
- 43 b) one or more security controls that should be implemented within the service perimeter to
- 44 meet the security requirements.

45 Each security control contains the ISO Controls 27002:2013 title and the specific control  
 46 statement, to satisfy the control objective. **The reader must refer directly to ISO 27002:2013,**  
 47 **to consider the “implementation guidance” sections relative to each control.**

48 Unless explicitly mentioned in the clarifications related to each specific control, the “other  
 49 information” sections are discarded.

Schedule 10 – Annex 2 – Security requirements and controls

---

50 *Note: The order of the information security management domains, security requirements and*  
51 *controls does not imply their importance.*

52

53 **4. Security requirements and controls**

54 (Empty chapter to match ISO control numbering)

55

56 **5. Information security policies**

57

58 **5.1 Management direction for information security**

59 Objective: To provide management direction and support for information security in accordance  
60 with business requirements and relevant laws and regulations.

61

62 **5.1.1 Policies for information security**

63 Control

64 A set of policies for information security should be defined, approved by management, published  
65 and communicated to employees and relevant external parties.

66 **Clarifications for Control 5.1.1**

67 This control refers to the Information Security Policy document approved by the service  
68 providing organisation's senior management which is communicated to all users and relevant  
69 Eurosystem governance bodies.

70 Supporting topic-specific documents are only communicated within the service providing  
71 organisation.

72

73 **5.1.2 Review of the policies for information security**

74 Control

75 The policies for information security should be reviewed at planned intervals or if significant  
76 changes occur to ensure their continuing suitability, adequacy and effectiveness.

77 **Clarifications for Control 5.1.2**

78 The senior management shall review the implementation of the information security management  
79 system every three years (Policy review interval) to ensure its continuing suitability, adequacy  
80 and effectiveness.

**Schedule 10 – Annex 2 – Security requirements and controls**

---

81 The management review shall include consideration of:  
 82 a) the status of actions from previous management reviews;  
 83 b) changes in external and internal issues that are relevant to the information security  
 84 management system;  
 85 c) feedback on the information security performance, including trends in:  
 86 1) nonconformities and corrective actions;  
 87 2) monitoring and measurement results;  
 88 3) audit results; and  
 89 4) fulfilment of information security objectives;  
 90 d) feedback from interested parties;  
 91 e) results of risk assessment and status of risk treatment plan; and  
 92 f) opportunities for continual improvement.  
 93 The outputs of the management review shall include decisions related to continual improvement  
 94 opportunities and any needs for changes to the information security management system.  
 95 The Service providing organisation shall retain documented information as evidence of the  
 96 results of management reviews.  
 97 The information security documentation (e.g. Information security policy, process, procedures  
 98 and guidelines) will be updated accordingly.  
 99

100 **6. Organization of information security**

101

102 **6.1 Internal organization**

103 Objective: To establish a management framework to initiate and control the implementation and  
 104 operation of information security within the organization.  
 105

106 **6.1.1 Information security roles and responsibilities**

107 Control

108 All information security responsibilities should be defined and allocated.

109 **Clarifications for Control 6.1.1**

110 Point e) is applicable to all new contracts and rolled out to existing ones progressively.

111 **6.1.2 Segregation of duties**

112 Control

113 Conflicting duties and areas of responsibility should be segregated to reduce opportunities for  
 114 unauthorized or unintentional modification or misuse of the organization’s assets.

## Schedule 10 – Annex 2 – Security requirements and controls

---

**115 Clarifications for Control 6.1.2**

116 For critical business functions, T2 and T2S use the four eyes principle (e.g. keying in by one user  
117 and authorization by another user with another account) in order to organise the needed  
118 segregation of duties.

119

**120 6.1.3 Contact with authorities**

121 Control

122 Appropriate contacts with relevant authorities should be maintained.

123

**124 6.1.4 Contact with special interest groups**

125 Control

126 Appropriate contacts with special interest groups or other specialist security forums and  
127 professional associations should be maintained.

128

**129 6.1.5 Information security in project management**

130 Control

131 Information security should be addressed in project management, regardless of the type of the  
132 project.

133

**134 6.2 Mobile devices and teleworking**

135 Objective: To ensure the security of teleworking and use of mobile devices.

136

**137 6.2.1 Mobile device policy**

138 Control

139 A policy and supporting security measures should be adopted to manage the risks introduced by  
140 using mobile devices.

141

**142 6.2.2 Teleworking**

143 Control

144 A policy and supporting security measures should be implemented to protect information  
145 accessed, processed or stored at teleworking sites.

146

**Schedule 10 – Annex 2 – Security requirements and controls**

---

**147 7. Human resource security**

148

**149 7.1 Prior to employment**

150 Objective: To ensure that employees and contractors understand their responsibilities and are  
151 suitable for the roles for which they are considered.

152

**153 7.1.1 Screening****154 Control**

155 Background verification checks on all candidates for employment should be carried out in  
156 accordance with relevant laws, regulations and ethics and should be proportional to the business  
157 requirements, the classification of the information to be accessed and the perceived risks.

158

**159 7.1.2 Terms and conditions of employment****160 Control**

161 The contractual agreements with employees and contractors should state their and the  
162 organization's responsibilities for information security.

163

**164 7.2 During employment**

165 Objective: To ensure that employees and contractors are aware of and fulfil their information  
166 security responsibilities.

167

**168 7.2.1 Management responsibilities****169 Control**

170 Management should require all employees and contractors to apply information security in  
171 accordance with the established policies and procedures of the organization.

172

173

**174 7.2.2 Information security awareness, education and training****175 Control**

176 All employees of the organization and, where relevant, contractors should receive appropriate  
177 awareness education and training and regular updates in organizational policies and procedures,  
178 as relevant for their job function.

**179 Clarifications for Control 7.2.2**

## Schedule 10 – Annex 2 – Security requirements and controls

---

180 The Information Security awareness program must include a chapter on Cyber resilience and  
181 social engineering.  
182 The T2/T2S Security awareness, education and training programme consists of academic training  
183 sessions provided by instructors over the 4 central banks. The frequency of these trainings is  
184 determined by the need of the various teams and approved by the Senior management. Specific  
185 requirements may also be triggered during the annual T2/T2S Information Security management  
186 framework review process. Beside these training sessions, security awareness initiatives are taken  
187 at domestic level such as participation in the European Cyber Security Month.  
188

### 189 7.2.3 Disciplinary process

#### 190 Control

191 There should be a formal and communicated disciplinary process in place to take action against  
192 employees who have committed an information security breach.  
193

### 194 7.3 Termination and change of employment

195 Objective: To protect the organization's interests as part of the process of changing or  
196 terminating employment.  
197

#### 198 7.3.1 Termination or change of employment responsibilities

##### 199 Control

200 Information security responsibilities and duties that remain valid after termination or change of  
201 employment should be defined, communicated to the employee or contractor and enforced.  
202  
203

### 204 8. Asset management

205

#### 206 8.1 Responsibility for assets

207 Objective: To identify organizational assets and define appropriate protection responsibilities.  
208

##### 209 8.1.1 Inventory of assets

###### 210 Control



## Schedule 10 – Annex 2 – Security requirements and controls

---

211 Information, other assets associated with information and information processing facilities should  
212 be identified and an inventory of these assets should be drawn up and maintained.

### 213 **Clarifications for Control 8.1.1**

214 The planned interval for reviewing the inventory of assets is three years (Asset Inventory Review  
215 Interval)

216 In order to reduce the work associated with drawing up the inventory grouping of assets is  
217 allowed. Criteria for grouping are:

- 218 a) similar assets;
- 219 b) similar security requirements;
- 220 c) assets are used in the same process and protection requirements are valid throughout;
- 221 d) assets can be considered as a unit.

222

### 223 **8.1.2 Ownership of assets**

#### 224 Control

225 Assets maintained in the inventory should be owned.

226

### 227 **8.1.3 Acceptable use of assets**

#### 228 Control

229 Rules for the acceptable use of information and of assets associated with information and  
230 information processing facilities should be identified, documented and implemented.

231

### 232 **8.1.4 Return of assets**

#### 233 Control

234 All employees and external party users should return all of the organizational assets in their  
235 possession upon termination of their employment, contract or agreement.

236

## 237 **8.2 Information classification**

238 Objective: To ensure that information receives an appropriate level of protection in accordance  
239 with its importance to the organization.

### 240 **8.2.1 Classification of information**

#### 241 Control

242 Information should be classified in terms of legal requirements, value, criticality and sensitivity  
243 to unauthorised disclosure or modification.

244

## Schedule 10 – Annex 2 – Security requirements and controls

---

### 245 **8.2.2 Labelling of information**

#### 246 Control

247 An appropriate set of procedures for information labelling should be developed and implemented  
248 in accordance with the information classification scheme adopted by the organization.

#### 249 **Clarifications for Control 8.2.2**

250 The ECB classification scheme is used as reference document as long as the ESCB scheme is not  
251 deployed.

252

### 253 **8.2.3 Handling of assets**

#### 254 Control

255 Procedures for handling assets should be developed and implemented in accordance with the  
256 information classification scheme adopted by the organization.

#### 257 **Clarifications for Control 8.2.3**

258 Distribution lists and lists of authorised recipients must be reviewed at planned intervals. The  
259 planned interval for the review of the distribution list of recipients is six months (Distribution  
260 List Review Interval).

261

262

263

### 264 **8.3 Media handling**

265 Objective: To prevent unauthorized disclosure, modification, removal or destruction of  
266 information stored on media.

267

#### 268 **8.3.1 Management of removable media**

##### 269 Control

270 Procedures should be implemented for the management of removable media in accordance with  
271 the classification scheme adopted by the organization.

##### 272 **Clarifications for Control 8.1.3**

273 d), f), i) are not applicable

274

#### 275 **8.3.2 Disposal of media**

##### 276 Control

277 Media should be disposed of securely when no longer required, using formal procedures.

278

**Schedule 10 – Annex 2 – Security requirements and controls**

---

**279 8.3.3 Physical media transfer****280 Control**

281 Media containing information should be protected against unauthorized access, misuse or  
282 corruption during transportation.

283

**284 9. Access control**

285

**286 9.1 Business requirements of access control**

287 Objective: To limit access to information and information processing facilities.

288

**289 9.1.1 Access control policy****290 Control**

291 An access control policy should be established, documented and reviewed based on business and  
292 information security requirements.

293

**294 Clarifications for Control 9.1.1**

295 The planned interval for reviewing the User Access Control Policy is 3 years (User Access  
296 Control Policy Review)

297 For staff having access to processing facilities via remote connection, strong authentication and  
298 identity verification is required.

299

**300 9.1.2 Access to networks and network services****301 Control**

302 Users should only be provided with access to the network and network services that they have  
303 been specifically authorized to use.

**304 Clarifications for Control 9.1.2**

305 A formal procedure for managing and controlling remote connections must be established.

306 Following controls must be in place:

307 a) Remote connections must only be activated when absolutely necessary and ask for re-  
308 authentication after a defined period of inactivity. The idle time after which a re-authentication of  
309 a remotely connected user is required is ten minutes (Remote Connections Idle Interval);

310 b) authentication by the use of cryptographic techniques and two-factor authentication;

311 c) If used, call-back facilities, must follow strict controls and procedures; call forwarding

312 processes should only be used if absolutely necessary;

## Schedule 10 – Annex 2 – Security requirements and controls

---

- 313 d) A logging of all remote connections must be in place.  
314 If remote connections are used for Third Party/vendor support  
315 a) the decision to allow remote access by TP/vendors is made case by case by the senior  
316 management and substantiated by a risk analysis;  
317 b) remote access must be allowed only for a limited period of time and only in case support can  
318 not be provided on site in time;  
319 c) contractual provisions for remote access must exist and must also be laid down as regards the  
320 commitment of vendors' personnel to the secrecy of data;  
321 d) access should be limited to read-only for diagnostic purposes. However, if more privileged  
322 access is required (e.g. in emergency cases) then the remote connection activity related to critical  
323 functions must be monitored;  
324 e) if used, call-back facilities, must follow strict controls and procedures; call forwarding  
325 processes should only be used if absolutely necessary;  
326 f) a logging of all remote connections must be in place.

327

### 328 **9.2 User access management**

329 Objective: To ensure authorized user access and to prevent unauthorized access to systems and  
330 services.

331

#### 332 **9.2.1 User registration and de-registration**

333 Control

334 A formal user registration and de-registration process should be implemented to enable  
335 assignment of access rights.

336

#### 337 **9.2.2 User access provisioning**

338 Control

339 A formal user access provisioning process should be implemented to assign or revoke access  
340 rights for all user types to all systems and services.

#### 341 **Clarifications for Control 9.2.2**

342 For T2 and T2S authorization is granted by the relevant management not by the system owner.

343

#### 344 **9.2.3 Management of privileged access rights**

345 Control

346 The allocation and use of privileged access rights should be restricted and controlled.

## Schedule 10 – Annex 2 – Security requirements and controls

---

347 **Clarifications for Control 9.2.3**

348 Privileges must be allocated to individuals on a need-to-use basis for normal operations and on an  
349 event-by-event basis for exceptional situations.

350

351 **9.2.4 Management of secret authentication information of users**

352 Control

353 The allocation of secret authentication information should be controlled through a formal  
354 management process.

355 **Clarifications for Control 9.2.4**

356 Alternative measures can be determined by the service providing organisation to ensure that users  
357 commit to keep secret authentication information confidential and to keep group secret  
358 authentication information solely within the members of the group.

359

360 **9.2.5 Review of user access rights**

361 Control

362 Asset owners should review users' access rights at regular intervals.

363

364 **Clarifications for Control 9.2.5**

365 The planned interval for reviewing the user access rights is 6 months (User Access Rights  
366 Review Interval)

367 The planned interval for reviewing the privileged user access rights is 3 months (Privileged User  
368 Access Rights Review Interval)

369 The period for keeping audit logs of changes to privileged accounts is 1 year (Privileged Account  
370 Changes Logging Period)

371

372 **9.2.6 Removal or adjustment of access rights**

373 Control

374 The access rights of all employees and external party users to information and information  
375 processing facilities should be removed upon termination of their employment, contract or  
376 agreement, or adjusted upon change.

377

378 **9.3 User responsibilities**

379 Objective: To make users accountable for safeguarding their authentication information.

380

## Schedule 10 – Annex 2 – Security requirements and controls

---

**381 9.3.1 Use of secret authentication information**

**382 Control**

383 Users should be required to follow the organization’s practices in the use of secret authentication  
384 information.

385

**386 9.4 System and application access control**

387 Objective: To prevent unauthorized access to systems and applications.

388

389

**390 9.4.1 Information access restriction**

**391 Control**

392 Access to information and application system functions should be restricted in accordance with  
393 the access control policy.

**394 Clarifications for Control 9.4.1**

395 The planned interval for the review of the service’s output to remove unnecessary information is  
396 three years (Service Output Review Interval).

397

**398 9.4.2 Secure log-on procedures**

**399 Control**

400 Where required by the access control policy, access to systems and applications should be  
401 controlled by a secure log-on procedure.

**402 Clarifications for Control 9.4.2**

403 The maximum number of failed logon attempts for user before the account is disabled is three  
404 attempts (Maximum Logon Attempts)

405 The period of inactivity before a user session is closed is 15 minutes (Session Time-Out)

406

**407 9.4.3 Password management system**

**408 Control**

409 Password management systems should be interactive and should ensure quality passwords.

**410 Clarifications for Control 9.4.3**

411 The minimum length for user passwords is 8 characters (Minimum Password Length)

412 The expiry period for passwords after which a change is required is 60 days (Password Expiry  
413 Period)

**Schedule 10 – Annex 2 – Security requirements and controls**

---

414 The period to keep previously used passwords to prevent reuse is 1 year (Period for Keeping  
415 Previous Passwords)

416

417 **9.4.4 Use of privileged utility programs**

418 Control

419 The use of utility programs that might be capable of overriding system and application controls  
420 should be restricted and tightly controlled.

421

422 **9.4.5 Access control to program source code**

423 Control

424 Access to program source code should be restricted.

425

426 **10. Cryptography**

427

428 **10.1 Cryptographic controls**

429 Objective: To ensure proper and effective use of cryptography to protect the confidentiality,  
430 authenticity and/or integrity of information.

431

432 **10.1.1 Policy on the use of cryptographic controls**

433 Control

434 A policy on the use of cryptographic controls for protection of information should be developed  
435 and implemented.

436

437 **10.1.2 Key management**

438 Control

439 A policy on the use, protection and lifetime of cryptographic keys should be developed and  
440 implemented through their whole lifecycle.

441

442 **11. Physical and environment security**

443

## Schedule 10 – Annex 2 – Security requirements and controls

---

444 **11.1 Secure areas**

445 Objective: To prevent unauthorized physical access, damage and interference to the  
446 organization's information and information processing facilities.

447

448

449 **11.1.1 Physical security perimeter**

450 Control

451 Security perimeters should be defined and used to protect areas that contain either sensitive or  
452 critical information and information processing facilities.

453

454 **11.1.2 Physical entry controls**

455 Control

456 Secure areas should be protected by appropriate entry controls to ensure that only authorized  
457 personnel are allowed access.

458 **Clarifications for Control 11.1.2**

459 The planned interval for reviewing physical entry controls is 3 months (Physical Entry Controls  
460 Review Interval)

461

462 **11.1.3 Securing offices, rooms and facilities**

463 Control

464 Physical security for offices, rooms and facilities should be designed and applied.

465 **Clarifications for Control 11.1.3**

466 Electromagnetic shielding is not considered

467

468 **11.1.4 Protecting against external and environmental threats**

469 Control

470 Physical protection against natural disasters, malicious attack or accidents should be designed  
471 and applied.

472

473 **11.1.5 Working in secure areas**

474 Control

475 Procedures for working in secure areas should be designed and applied.

476



Schedule 10 – Annex 2 – Security requirements and controls

---

477 **11.1.6 Delivery and loading areas**

478 Control

479 Access points such as delivery and loading areas and other points where unauthorized persons  
480 could enter the premises should be controlled and, if possible, isolated from information  
481 processing facilities to avoid unauthorized access.

482 **Clarifications for Control 11.1.6**

483 g) is not considered

484

485 **11.2 Equipment**

486 Objective: To prevent loss, damage, theft or compromise of assets and interruption to the  
487 organization's operations.

488

489 **11.2.1 Equipment siting and protection**

490 Control

491 Equipment should be sited and protected to reduce the risks from environmental threats and  
492 hazards, and opportunities for unauthorized access.

493

494 **11.2.2 Supporting utilities**

495 Control

496 Equipment should be protected from power failures and other disruptions caused by failures in  
497 supporting utilities.

498

499 **11.2.3 Cabling security**

500 Control

501 Power and telecommunications cabling carrying data or supporting information services should  
502 be protected from interception, interference or damage.

503 **Clarifications for Control 11.2.3**

504 c2) is not considered c3) is implemented via other means

505

506 **11.2.4 Equipment maintenance**

507 Control

508 Equipment should be correctly maintained to ensure its continued availability and integrity.

509

## Schedule 10 – Annex 2 – Security requirements and controls

---

510 **11.2.5 Removal of assets**

511 Control

512 Equipment, information or software should not be taken off-site without prior authorization.

513

514 **11.2.6 Security of equipment and assets off-premises**

515 Control

516 Security should be applied to off-site assets taking into account the different risks of working

517 outside the organization's premises.

518 **Clarifications for Control 11.2.6**

519 **Standard ISO 27033 is not considered.**

520

521 **11.2.7 Secure disposal or re-use of equipment**

522 Control

523 All items of equipment containing storage media should be verified to ensure that any sensitive

524 data and licensed software has been removed or securely overwritten prior to disposal or re-use.

525

526 **11.2.8 Unattended user equipment**

527 Control

528 Users should ensure that unattended equipment has appropriate protection.

529

530 **11.2.9 Clear desk and clear screen policy**

531 Control

532 A clear desk policy for papers and removable storage media and a clear screen policy for

533 information processing facilities should be adopted.

534

535

536 **12. Operations security**

537

538 **12.1 Operational procedures and responsibilities**

539 Objective: To ensure correct and secure operations of information processing facilities.

540

## Schedule 10 – Annex 2 – Security requirements and controls

---

541 **12.1.1 Documented operating procedures**

542 Control

543 Operating procedures should be documented and made available to all users who need them.

544

545 **12.1.2 Change management**

546 Control

547 Changes to the organization, business processes, information processing facilities and systems  
548 that affect information security should be controlled.

549 **Clarifications for Control 12.1.2**

550 This control has to be considered in light of the Change Management Process.

551 Change of physical location is a NCB domestic issue and is not considered.

552

553 **12.1.3 Capacity management**

554 Control

555 The use of resources should be monitored, tuned and projections made of future capacity  
556 requirements to ensure the required system performance.

557

558 **12.1.4 Separation of development, testing and operational environments**

559 Control

560 Development, testing, and operational environments should be separated to reduce the risks of  
561 unauthorized access or changes to the operational environment.

562 **Clarifications for Control 12.1.4**

563 The separation of development, testing and operational environment may be ensured by use of  
564 logical partitioning or virtualisation techniques.

565

566 **12.2 Protection from malware**

567 Objective: To ensure that information and information processing facilities are protected against  
568 malware.

569

570 **12.2.1 Controls against malware**

571 Control

572 Detection, prevention and recovery controls to protect against malware should be implemented,  
573 combined with appropriate user awareness.

574 **Clarifications for Control 12.2.1**

## Schedule 10 – Annex 2 – Security requirements and controls

---

575 Where it is possible, non-persistent workstations (virtual machines) must be used. This helps to  
576 eliminate malicious software.

577 Where malware detection software cannot be installed, alternative detection mechanisms must be  
578 put in place such as the performance of information security test campaigns including the  
579 assessment of technical vulnerabilities, detection of spurious files and unknown pieces of  
580 software. Appropriate remediation actions must be taken according to the criticality of the  
581 vulnerabilities detected, the harmfulness of malware and the negative impact they may have.

582

583 Regarding connections to business applications over external networks, unauthorised mobile  
584 code must be prevented from executing. In this context, authorised mobile code must be signed  
585 by a recognised authority and verification of the signature of the mobile code must take place  
586 prior to its execution.

587 l) Isolation can be either physical or logical

588

### 589 **12.3 Backup**

590 Objective: To protect against loss of data.

591

#### 592 **12.3.1 Information backup**

593 Control

594 Backup copies of information, software and system images should be taken and tested regularly  
595 in accordance with an agreed backup policy.

596

597

#### 598 **Clarifications for Control 12.3.1**

599 The planned interval for checking the system restoration from backup is 1 year (Restoration  
600 Check Interval).

601

### 602 **12.4 Logging and monitoring**

603 Objective: To record events and generate evidence.

604

#### 605 **12.4.1 Event logging**

606 Control

607 Event logs recording user activities, exceptions, faults and information security events should be  
608 produced, kept and regularly reviewed.

**Schedule 10 – Annex 2 – Security requirements and controls**

---

609

**12.4.2 Protection of log information****Control**

612 Logging facilities and log information should be protected against tampering and unauthorized  
613 access.

614

**12.4.3 Administrator and operator logs****Control**

617 System administrator and system operator activities should be logged and the logs protected and  
618 regularly reviewed.

**Clarifications for Control 12.4.3**

620 System administrator and system operator activities must be recorded in audit logs. 621

The planned interval for reviewing privileged activities on the service is 1 business  
day 622 (Privileged Activities Review Interval)

623 The planned interval for reviewing system administrator and operator logs is 1 week

624 (Administrator Log Review Interval)

625

**12.4.4 Clock synchronisation****Control**

628 The clocks of all relevant information processing systems within an organization or security  
629 domain should be synchronised to a single reference time source.

630

**12.5 Control of operational software**

632 Objective: To ensure the integrity of operational systems.

633

**12.5.1 Installation of software on operational systems****Control**

636 Procedures should be implemented to control the installation of software on operational systems.

**Clarifications for Control 12.5.1**

638 Old versions of operating system software as well as old versions of scripts used for operational  
639 activities must be archived, together with all required information and parameters, procedures,  
640 configuration details and supporting software for as long as the data are retained in the archive.

641

## Schedule 10 – Annex 2 – Security requirements and controls

---

642 **12.6 Technical vulnerability management**

643 Objective: To prevent exploitation of technical vulnerabilities.

644

645 **12.6.1 Management of technical vulnerabilities**

646 Control

647 Information about technical vulnerabilities of information systems being used should be obtained  
648 in a timely fashion, the organization's exposure to such vulnerabilities evaluated and appropriate  
649 measures taken to address the associated risk.

650

651 **12.6.2 Restrictions on software installation**

652 Control

653 Rules governing the installation of software by users should be established and implemented.

654

655 **12.7 Information systems audit considerations**

656 Objective: To minimise the impact of audit activities on operational systems.

657

658 **12.7.1 Information systems audit controls**

659 Control

660 Audit requirements and activities involving verification of operational systems should be  
661 carefully planned and agreed to minimize disruptions to business processes.

662

663 **13. Communications security**

664

665 **13.1 Network security management**

666 Objective: To ensure the protection of information in networks and its supporting information  
667 processing facilities.

668

669 **13.1.1 Network controls**

670 Control

671 Networks should be managed and controlled to protect information in systems and applications.

672 **Clarifications for Control 13.1.1 (f and g)**

673 **Equipment identification in networks:**

## Schedule 10 – Annex 2 – Security requirements and controls

---

674 Automatic equipment identification must be implemented as a means to authenticate connections  
675 from specific locations and equipment.

676 Network routing control:

677 Routing controls must be implemented for networks to ensure that computer connections and  
678 information flows do not breach the access control policy of the business applications.

679 Routing controls must be based on positive checks of source and destination address

680

### 681 **13.1.2 Security of network services**

#### 682 Control

683 Security mechanisms, service levels and management requirements of all network services  
684 should be identified and included in network services agreements, whether these services are  
685 provided in-house or outsourced.

686

### 687 **13.1.3 Segregation in networks**

#### 688 Control

689 Groups of information services, users and information systems should be segregated on networks.

#### 690 **Clarifications for Control 13.1.3**

691 The segregation can be implemented from a logical point of view.

692

## 693 **13.2 Information transfer**

694 Objective: To maintain the security of information transferred within an organization and with  
695 any external entity.

696

### 697 **13.2.1 Information transfer policies and procedures**

#### 698 Control

699 Formal transfer policies, procedures and controls should be in place to protect the transfer of  
700 information through the use of all types of communication facilities.

701

### 702 **13.2.2 Agreements on information transfer**

#### 703 Control

704 Agreements should address the secure transfer of business information between the organization  
705 and external parties.

706

**Schedule 10 – Annex 2 – Security requirements and controls**

---

707 **13.2.3 Electronic messaging**708 Control

709 Information involved in electronic messaging should be appropriately protected.

710

711 **13.2.4 Confidentiality or non-disclosure agreements**712 Control713 Requirements for confidentiality or non-disclosure agreements reflecting the organization's needs  
714 for the protection of information should be identified, regularly reviewed and documented.715 **Clarifications for Control 13.2.4**716 The planned interval for reviewing confidentiality agreements is 3 years (Confidentiality  
717 Agreement Review Interval)

718

719 **14. System acquisition, development and maintenance**

720

721 **14.1 Security requirements of information systems**722 Objective: To ensure that information security is an integral part of information systems across  
723 the entire lifecycle. This also includes the requirements for information systems which provide  
724 services over public networks.

725

726 **14.1.1 Information security requirements analysis and specification**727 Control728 The information security related requirements should be included in the requirements for new  
729 information systems or enhancements to existing information systems.

730

731 **14.1.2 Securing application services on public networks**732 Control733 Information involved in application services passing over public networks should be protected  
734 from fraudulent activity, contract dispute and unauthorized disclosure and modification.

735

736 **14.1.3 Protecting application services transactions**737 Control



## Schedule 10 – Annex 2 – Security requirements and controls

---

738 Information involved in application service transactions should be protected to prevent  
739 incomplete transmission, mis-routing, unauthorized message alteration, unauthorized disclosure,  
740 unauthorized message duplication or replay.

741

### 742 **14.2 Security in development and support processes**

743 Objective: To ensure that information security is designed and implemented within the  
744 development lifecycle of information systems.

745

#### 746 **14.2.1 Secure development policy**

747 Control

748 Rules for the development of software and systems should be established and applied to  
749 developments within the organization.

750

#### 751 **14.2.2 System change control procedures**

752 Control

753 Changes to systems within the development lifecycle should be controlled by the use of formal  
754 change control procedures.

755

#### 756 **14.2.3 Technical review of applications after operating platform changes**

757 Control

758 When operating platforms are changed, business critical applications should be reviewed and  
759 tested to ensure there is no adverse impact on organizational operations or security.

#### 760 **Clarifications for Control 14.2.3**

761 **Such reviews and tests ensuring that the operating platform change has no impact on the business**  
762 **applications must be performed before the deployment of any change whenever this is technically**  
763 **feasible or at least before opening the service in production.**

764

#### 765 **14.2.4 Restrictions on changes to software packages**

766 Control

767 Modifications to software packages should be discouraged, limited to necessary changes and all  
768 changes should be strictly controlled.

769

Schedule 10 – Annex 2 – Security requirements and controls

---

770 **14.2.5 Secure system engineering principles**

771 Control

772 Principles for engineering secure systems should be established, documented, maintained and  
773 applied to any information system implementation efforts.

774 **Clarifications for Control 14.2.5**

775 Validation checks should be incorporated into applications to detect any corruption of  
776 information through processing errors or deliberate acts.

777 The design and implementation of applications should ensure that the risks of processing failures  
778 leading to a loss of integrity are minimized. Specific areas to consider include:

- 779 a) the use of add, modify, and delete functions to implement changes to data;
- 780 b) the procedures to prevent programs running in the wrong order or running after failure of prior  
781 processing;
- 782 c) the use of appropriate programs to recover from failures to ensure the correct processing of  
783 data;
- 784 d) protection against attacks using buffer overruns/overflows.

785 An appropriate checklist should be prepared, activities documented, and the results should be  
786 kept secure. Examples of checks that can be incorporated include the following:

- 787 a) session or batch controls, to reconcile data file balances after transaction updates;
- 788 b) balancing controls, to check opening balances against previous closing balances, namely:
  - 789 1) run-to-run controls;
  - 790 2) file update totals;
  - 791 3) program-to-program controls;
- 792 c) validation of system-generated input data;
- 793 d) checks on the integrity, authenticity or any other security feature of data or software;  
794 downloaded, or uploaded, between central and remote computers;
- 795 e) hash totals of records and files;
- 796 f) checks to ensure that application programs are run at the correct time;
- 797 g) checks to ensure that programs are run in the correct order and terminate in case of a failure,  
798 and that further processing is halted until the problem is resolved;
- 799 h) creating a log of the activities involved in the processing.

800

801 **14.2.6 Secure development environment**

802 Control

803 Organizations should establish and appropriately protect secure development environments for  
804 system development and integration efforts that cover the entire system development lifecycle.

805

## Schedule 10 – Annex 2 – Security requirements and controls

---

### 806 **14.2.7 Outsourced development**

#### 807 Control

808 The organization should supervise and monitor the activity of outsourced system development.

#### 809 **Clarifications for Control 14.2.7**

810 If open source software is used the following controls must be applied:

811 1. downloaded from a trusted source

812 2. integrity check

813 3. verifying the general licensing arrangements (e.g. GNU license)

814

### 815 **14.2.8 System security testing**

#### 816 Control

817 Testing of security functionality should be carried out during development.

#### 818 **Clarifications for Control 14.2.8**

819 For T2 and T2S the User testing is covering the need for independent acceptance testing.

820

### 821 **14.2.9 System acceptance testing**

#### 822 Control

823 Acceptance testing programs and related criteria should be established for new information  
824 systems, upgrades and new versions.

#### 825 **Clarifications for Control 14.2.9**

826 Tests involving users and operations functions are carried out to confirm that all acceptance  
827 criteria have been fully satisfied. All the testing activities and results must be properly  
828 documented.

829

### 830 **14.3 Test data**

831 Objective: To ensure the protection of data used for testing.

832

#### 833 **14.3.1 Protection of test data**

##### 834 Control

835 Test data should be selected carefully, protected and controlled.

836

## 837 **15. Supplier relationships**

838

## Schedule 10 – Annex 2 – Security requirements and controls

---

839 **15.1 Information security in supplier relationships**

840 Objective: To ensure protection of the organization's assets that is accessible by suppliers.

841

842 **15.1.1 Information security policy for supplier relationships**

843 Control

844 Information security requirements for mitigating the risks associated with supplier's access to the  
845 organization's assets should be agreed with the supplier and documented.

846

847 **15.1.2 Addressing security within supplier agreements**

848 Control

849 All relevant information security requirements should be established and agreed with each  
850 supplier that may access, process, store, communicate, or provide IT infrastructure components  
851 for, the organization's information.

852

853 **15.1.3 Information and communication technology supply chain**

854 Control

855 Agreements with suppliers should include requirements to address the information security risks  
856 associated with information and communications technology services and product supply chain.

857

858 **15.2 Supplier service delivery management**

859 Objective: To maintain an agreed level of information security and service delivery in line with  
860 supplier agreements.

861

862 **15.2.1 Monitoring and review of supplier services**

863 Control

864 Organizations should regularly monitor, review and audit supplier service delivery.

865 **Clarifications for Control 15.2.1**

866 For all T2S relevant supplier services of the NCBs, the requirements from the new ISO 27002  
867 implementation guidance will be included in the new contracts and, if not already covered, in the  
868 renewal or renegotiation of existing contracts.

869

870 **15.2.2 Managing changes to supplier services**

871 Control

## Schedule 10 – Annex 2 – Security requirements and controls

---

872 Changes to the provision of services by suppliers, including maintaining and improving existing  
873 information security policies, procedures and controls, should be managed, taking account of the  
874 criticality of business information, systems and processes involved and re-assessment of risks.  
875

### 876 **16. Information security incident management**

877

#### 878 **16.1 Management of information security incidents and improvements**

879 Objective: To ensure a consistent and effective approach to the management of information  
880 security incidents, including communication on security events and weaknesses.

881

##### 882 **16.1.1 Responsibilities and procedures**

883 Control

884 Management responsibilities and procedures should be established to ensure a quick, effective  
885 and orderly response to information security incidents.

886

##### 887 **16.1.2 Reporting information security events**

888 Control

889 Information security events should be reported through appropriate management channels as  
890 quickly as possible.

891

##### 892 **16.1.3 Reporting information security weaknesses**

893 Control

894 Employees and contractors using the organization's information systems and services should be  
895 required to note and report any observed or suspected information security weaknesses in  
896 systems or services.

##### 897 **Clarifications for Control 16.1.3**

898 All Users must be aware of the reporting mechanism and the designated point of contact defined  
899 by the relevant management of the service providing organisation.

900

##### 901 **16.1.4 Assessment of and decision on information security events**

902 Control

## Schedule 10 – Annex 2 – Security requirements and controls

---

903 Information security events should be assessed and it should be decided if they are to be  
904 classified as information security incidents.

905

### 906 **16.1.5 Response to information security incidents**

#### 907 Control

908 Information security incidents should be responded to in accordance with the documented  
909 procedures.

910

### 911 **16.1.6 Learning from information security incidents**

#### 912 Control

913 Knowledge gained from analysing and resolving information security incidents should be used to  
914 reduce the likelihood or impact of future incidents.

915

### 916 **16.1.7 Collection of evidence**

#### 917 Control

918 The organization should define and apply procedures for the identification, collection, acquisition  
919 and preservation of information, which can serve as evidence.

920

## 921 **17. Information security aspects of business continuity management**

922

### 923 **17.1 Information security continuity**

924 Objective: Information security continuity should be embedded in the organization's business  
925 continuity management systems.

926

#### 927 **17.1.1 Planning information security continuity**

##### 928 Control

929 The organization should determine its requirements for information security and the continuity of  
930 information security management in adverse situations, e.g. during a crisis or disaster.

931

#### 932 **17.1.2 Implementing information security continuity**

##### 933 Control

## Schedule 10 – Annex 2 – Security requirements and controls

---

934 The organization should establish, document, implement and maintain processes, procedures and  
935 controls to ensure the required level of continuity for information security during an adverse  
936 situation.

937

### 938 **17.1.3 Verify, review and evaluate information security continuity**

#### 939 Control

940 The organization should verify the established and implemented information security continuity  
941 controls at regular intervals in order to ensure that they are valid and effective during adverse  
942 situations.

#### 943 **Clarifications for Control 17.1.3**

944 **The planned interval for exercising and testing the information security aspects of the business**  
945 **continuity plan is 6 months (Business Continuity Test Interval)**

946 **The planned interval for reviewing the information security aspects of the business continuity**  
947 **plan is 6 months (Business Continuity Review Interval)**

948

### 949 **17.2 Redundancies**

950 Objective: To ensure availability of information processing facilities.

951

#### 952 **17.2.1 Availability of information processing facilities**

##### 953 Control

954 Information processing facilities should be implemented with redundancy sufficient to meet  
955 availability requirements.

956

## 957 **18. Compliance**

958

### 959 **18.1 Compliance with legal and contractual requirements**

960 Objective: To avoid breaches of legal, statutory, regulatory or contractual obligations related to  
961 information security and of any security requirements.

962

## Schedule 10 – Annex 2 – Security requirements and controls

---

963 **18.1.1 Identification of applicable legislation and contractual requirements**

964 Control

965 All relevant legislative statutory, regulatory, contractual requirements and the organization's  
966 approach to meet these requirements should be explicitly identified, documented and kept up to  
967 date for each information system and the organization.

968

969 **18.1.2 Intellectual property rights**

970 Control

971 Appropriate procedures should be implemented to ensure compliance with legislative, regulatory  
972 and contractual requirements related to intellectual property rights and use of proprietary  
973 software products.

974

975 **18.1.3 Protection of records**

976 Control

977 Records should be protected from loss, destruction, falsification, unauthorized access and  
978 unauthorized release, in accordance with legislative, regulatory, contractual and business  
979 requirements.

980

981 **18.1.4 Privacy and protection of personally identifiable information**

982 Control

983 Privacy and protection of personally identifiable information should be ensured as required in  
984 relevant legislation and regulation where applicable.

985

986 **18.1.5 Regulation of cryptographic controls**

987 Control

988 Cryptographic controls should be used in compliance with all relevant agreements, legislation  
989 and regulations.

990

991 **18.2 Information security reviews**

992 Objective: To ensure that information security is implemented and operated in accordance with  
993 the organizational policies and procedures.

994



**Schedule 10 – Annex 2 – Security requirements and controls**

---

**995 18.2.1 Independent review of information security****996 Control**

997 The organization's approach to managing information security and its implementation (i.e.  
998 control objectives, controls, policies, processes and procedures for information security) should  
999 be reviewed independently at planned intervals or when significant changes occur.

**1000 Clarifications for Control 18.2.1**

1001 The Eurosystem defines the approach to managing information security and initiates the  
1002 independent review of this approach and its implementation by the service providing  
1003 organisation.

1004 The planned interval for an independent review of the approach to managing information security  
1005 and its implementation is 3 years (Independent Security Review Interval)

1006

**1007 18.2.2 Compliance with security policies and standards****1008 Control**

1009 Managers should regularly review the compliance of information processing and procedures  
1010 within their area of responsibility with the appropriate security policies, standards and any other  
1011 security requirements.

**1012 Clarifications for Control 18.2.2**

1013 The planned interval for full compliance review of the service with security policies and  
1014 requirements is 3 years (Compliance Review Interval)

1015

**1016 18.2.3 Technical compliance review****1017 Control**

1018 Information systems should be regularly reviewed for compliance with the organization's  
1019 information security policies and standards.

**1020 Clarifications for Control 18.2.3**

1021 The planned interval for checking the technical compliance of the platform is 1 year (Technical  
1022 Compliance Check Interval)

1023 Information systems should also be regularly reviewed for compliance with the information  
1024 security requirements.

1025

# **CURRENCY PARTICIPATION AGREEMENT**

## **SCHEDULE 11**

### **EXIT MANAGEMENT**

# Currency Participation Agreement

## Schedule 11 – Exit Management

---

### Table of contents

<b>1</b>	<b>Introduction .....</b>	<b>1</b>
<b>2</b>	<b>Scope and general approach of Exit Management.....</b>	<b>2</b>
2.1	Scope .....	2
2.2	General approach of Exit Management.....	2
<b>3</b>	<b>Exit of the [NCB] .....</b>	<b>3</b>
3.1	General responsibilities of the parties .....	3
3.2	Responsibilities of the [NCB] .....	4
3.3	Responsibilities of the Eurosystem .....	4

# Currency Participation Agreement

## Schedule 11 – Exit Management

---

### 1 **1 Introduction**

2 This Schedule sets out the provisions related to preparing and supporting the exit of the [NCB]  
3 and its Dedicated Cash Accounts Holders, as well as the roles and responsibilities of the parties  
4 during the exit process.

5 This Schedule does not cover the possible causes of termination and their consequences, nor the  
6 decision-making process, including arbitration and escalation, which will take place in case one  
7 contracting party does not accept the other contracting party's termination of the Currency  
8 Participation Agreement for cause.

9 The Schedule is divided into two chapters i) scope and general approach of the Exit  
10 Management; ii) exit of a Connected NCB to T2S addressing the responsibilities of the Parties.

# Currency Participation Agreement

## Schedule 11 – Exit Management

---

### 11 **2 Scope and general approach of Exit Management**

#### 12 **2.1 Scope**

13 This Schedule describes the operational and mutual support principles that will apply from the  
14 moment the [NCB] has formally notified the Eurosystem of its decision to exit T2S, either for  
15 convenience or for cause, or from the moment the Eurosystem has formally notified the [NCB]  
16 that it wishes to terminate the Currency Participation Agreement. Notifications are given by way  
17 of an official termination notice, either from the [NCB] to the Eurosystem, or from the  
18 Eurosystem to the [NCB].

#### 19 **2.2 General approach of Exit Management**

20 Unless otherwise agreed between the Parties in writing, the exit of [NCB] from T2S will consist  
21 of a full de-migration of the [NCB]'s business on a given date (i.e. “big-bang” approach) from  
22 the T2S Platform. Such exit shall take place over a weekend, targeting to avoid sensitive  
23 weekends (e.g. end-of-month, end-of quarter).

# Currency Participation Agreement

## Schedule 11 – Exit Management

---

### 24 3 Exit of the [NCB]

#### 25 3.1 General responsibilities of the parties

- 26 a) It is the responsibility of the Eurosystem to co-ordinate, steer and monitor the exit process. In  
27 agreement with the [NCB], it establishes the exit plan, the tasks and the milestones for the  
28 exit process and monitors compliance with the agreed procedures, tasks and milestones.
- 29 b) It is the responsibility of the [NCB] to ensure its own readiness for the exit from T2S by the  
30 committed date according to the procedures and processes agreed with the Eurosystem and  
31 other T2S Actors.
- 32 c) As soon as the formal termination notice has been sent and acknowledged, both the  
33 Eurosystem and the exiting [NCB] shall start work to provide for a smooth exit. Both parties  
34 shall appoint an “Exit Manager”, whose main responsibility consists in co-ordinating the exit  
35 activities and acting as liaison for the other party.
- 36 d) To the extent possible, the parties shall use all reasonable endeavor to minimize the effects of  
37 the exit on T2S and on the CSDs whose participants make use of the [NCB], in particular on  
38 the national market of the [NCB].
- 39 e) When the [NCB] exits T2S, settlement in its currency in T2S will no longer be possible and  
40 the CSD settling transactions in that currency can no longer make the same use of T2S.
- 41 f) It is the responsibility of the [NCB] to co-ordinate all exit activities with its DCA Holders.  
42 The Eurosystem will co-ordinate with those CSDs whose participants make use of funds on  
43 those accounts for the settlement of securities transactions.
- 44 g) Unless otherwise agreed between the parties, the time between the termination of the  
45 Agreement and the actual exit weekend shall not exceed a period of 2 years. If the [NCB] or  
46 the relevant CSD(s) are not prepared to exit T2S within this period, then the [NCB] shall in  
47 good faith negotiate a solution on the extended usage of the T2S Services, as well as on the  
48 remaining time until exit is possible. The [NCB] may choose a shorter exit period, provided  
49 all relevant CSDs have been informed about the exit procedures and have had sufficient time  
50 to prepare for the simultaneous exit of T2S in relation to settlement of the currency of the  
51 [NCB].
- 52 h) For the purpose of the Currency Participation Agreement, the exit process ends when the  
53 adaptations are completed so that there are no more funds on the DCAs managed by the  
54 [NCB] and the currency no longer can be settled in T2S. Unless otherwise agreed between  
55 the parties, the exit of [NCB] from T2S will take the form of a simultaneous inactivation of  
56 all Dedicated Cash Accounts operated by the [NCB], so as to prevent any further transfers of  
57 funds between the RTGS system and T2S. These activities will take place during a week-end

# Currency Participation Agreement

## Schedule 11 – Exit Management

---

58 agreed upon by both parties and called the exit week-end.

59 i) After the completion of the exit process, and until the end of the legal archiving period, the  
60 Eurosystem shall continue to provide information – including but not limited to transaction  
61 data – to the [NCB], upon the latter’s request, with respect to the services provided by the  
62 Eurosystem to the [NCB] in the context of the Currency Participation Agreement. Upon the  
63 [NCB]’s request, access to such information shall be provided by other means – to be agreed  
64 between the Eurosystem and the [NCB] – than using the T2S Network Service Provider.

### 65 3.2 Responsibilities of the [NCB]

66 In view of ensuring a successful exit from T2S, the [NCB] shall:

67 a) deliver to the Eurosystem, at the latest one month after the official termination notice, a high-  
68 level exit plan clearly defining all activities that the [NCB] itself, its DCA Holders, the  
69 Eurosystem, and, where relevant, any CSD are to perform;

70 b) deliver to the Eurosystem, at the latest two months after the delivery of the high-level Exit  
71 Plan, an overview of the required support for the execution of all exit activities, which the  
72 [NCB] expects from the Eurosystem;

73 c) monitor and take all necessary measures to facilitate the readiness of its DCA Holders for the  
74 exit from T2S;

75 d) co-operate with the Eurosystem in preparation of the exit plan and the detailed exit weekend  
76 script;

77 e) co-ordinate all exit activities with its community, and confirm the successful completion of  
78 the activities to the Eurosystem;

79 f) inform the Eurosystem of any unexpected event or delay of a planned activity, which may  
80 affect the execution of the Eurosystem’s support activities or the exit plan.

### 81 3.3 Responsibilities of the Eurosystem

82 In view of ensuring a successful exit from T2S, the Eurosystem shall:

83 a) continue to provide all services and support as specified in the Currency Participation  
84 Agreement, until the exit weekend;

85 b) provide reasonable support to the [NCB] in preparing its high-level exit plan;

86 c) indicate to the [NCB] within one month after the receipt of the high-level exit plan, any  
87 constraints and conditions applicable to the support it can provide;

88 d) assist the [NCB] in preparing its detailed support request to the Eurosystem, in particular by  
89 indicating specific areas where the Eurosystem can offer such support;

## Currency Participation Agreement

### Schedule 11 – Exit Management

---

- 90 e) agree with the [NCB] within one month after the receipt of the detailed support request the  
91 precise activities that the Eurosystem will conduct, and their timing;
- 92 f) support the [NCB] in establishing the exit plan, including aspects related to its Dedicated  
93 Cash Accounts, major project milestones, as well as checkpoints to be met before the start of  
94 the exit weekend;
- 95 g) inform the [NCB] within one month after reaching an agreement on the exit plan of the  
96 amount of any costs for planning, coordination and execution of exit activities – beyond the  
97 normal operational support, which it expects the [NCB] to reimburse, unless the [NCB] has  
98 terminated the agreement for cause, in which case the Eurosystem will provide such support  
99 free of charge;
- 100 h) upon agreement with the [NCB] on the costs the latter will reimburse, make all reasonable  
101 efforts to conduct the agreed activities, including communication and coordination with other  
102 T2S Actors, and where relevant confirm their successful completion to the [NCB];
- 103 i) establish the detailed exit weekend script which provides the [NCB] with the required  
104 information to execute the tasks and/or to carry out the actions required during the exit  
105 weekend;
- 106 j) provide all reasonable support to the [NCB] to address any unexpected events during the exit  
107 process;
- 108 k) establish the fall-back arrangements and roll-back procedures specific for the exit, in order to  
109 manage the necessary processes if the exit needs to be deferred to a later stage due to  
110 predictable or unforeseen circumstances, and/or if the activities already performed during the  
111 exit weekend need to be unwound if the exit has to be stopped.



# **CURRENCY PARTICIPATION AGREEMENT**

## **SCHEDULE 12**

### **PROCEDURE FOR PAYMENT OF CLAIMS**

**Currency Participation Agreement**  
**Schedule 12 – Procedure for Payment of Claims**

---

**Table of contents**

**1. PROCEDURE IN RESPECT OF ARTICLE 28 (LIABILITY RULES)..... 1**

**2. PROCEDURE IN RESPECT OF CLAIMS PURSUANT TO ARTICLE 29(1).....2**

**3. PROCEDURE IN RESPECT OF ARTICLE 33(4) (INFRINGEMENT OF IPR).....4**

# Currency Participation Agreement

## Schedule 12 – Procedure for Payment of Claims

---

1 For the purposes of this Schedule, either Party asserting a claim against the other Party is referred  
2 to as “Claimant”, while the other Party is referred to as “Respondent”.

### 3 **1. Procedure in respect of Article 28 (Liability rules)**

4 The following procedure applies to the handling of any claim pursuant to Article 28 of this  
5 Agreement:

- 6 (a) The Claimant shall, without undue delay, notify the Respondent of the occurrence of any  
7 event which the Claimant reasonably believes may give rise to a claim based on Article 28  
8 of this Agreement, and in any case no later than within [30] calendar days from the  
9 occurrence of such event or, in the event the Claimant did not know that an event would  
10 give rise to a claim, as from the moment it has the relevant knowledge that such event  
11 would give rise to a claim.
- 12 (b) The Claimant shall submit its claim against the Respondent without undue delay, and in  
13 any case no later than within 12 months from the occurrence of the event which gave rise  
14 to the claim or, if the Claimant did not know that an event gave rise to a claim for liability  
15 or indemnification, , within 12 months from the moment it knew or should reasonably have  
16 known of such a claim. After the expiry of this period, the Respondent shall be entitled to  
17 reject the claim.
- 18 (c) The Claimant shall submit its claim to the Respondent in writing, specifying its basis, its  
19 justification and, to the extent known, the claimed amount, to allow the Respondent to  
20 assess the merits of the submitted claim.
- 21 (d) The Respondent may request any additional information from the Claimant as may be  
22 reasonably required for assessing the merits of the claim. The Claimant shall cooperate in  
23 good faith and in a timely manner with the Respondent.
- 24 (e) The Respondent shall, without undue delay, notify the Claimant in writing if it accepts the  
25 claim or rejects it in whole or in part, in the latter case giving reasons for the rejection.
- 26 (f) In case of dispute as to the merits of the claim, the Parties shall make any effort to find an  
27 amicable arrangement. As the case may be, the Parties shall take recourse to Article 47 of  
28 this Agreement.
- 29 (g) If the Respondent has accepted the claim as merited, in whole or in part, or if it was settled  
30 either by an amicable arrangement between the Parties or through court proceedings  
31 pursuant to Article 47, the Respondent shall, subject to paragraphs (b), (h) and (i), pay out  
32 the claim as soon as reasonably practicable and at the latest within 90 calendar days after  
33 the end of this calendar year. Any payment pursuant to Article 28 of this Agreement is  
34 subject to the limitations of Article 28(5)(a) of this Agreement and shall be made on a

# Currency Participation Agreement

## Schedule 12 – Procedure for Payment of Claims

---

35 provisional basis subject to the reservations of paragraphs (h) and (i). The Claimant shall  
36 not be entitled to claim interest or damages for late payment in relation to the time elapsed  
37 prior to the expiry of the period of 90 calendar days.

38 (h) If the liability of the Eurosystem vis-à-vis the [NCB] is limited in accordance with Article  
39 28(5)(a) of this Agreement and the amounts payable to the [NCB] and, as the case may be,  
40 to other Connected NCBs are reduced accordingly, the Eurosystem shall notify all  
41 Claimants as soon as practicably possible after the end of the relevant calendar year  
42 referred to in paragraph (g); the notification shall give sufficient evidence of the reasons  
43 for, and the calculation of, the reduced compensation amounts in relation to the amounts  
44 that had been claimed.

45 (i) If a claim is accepted as merited by the Eurosystem after the end of the calendar year in  
46 which the event occurred that caused the claim or settled by an amicable arrangement  
47 between the Parties, or settled in accordance with Article 47 of this Agreement after the  
48 end of this calendar year, the Eurosystem shall pay such claim as soon as reasonably  
49 practicable. If such a claim should be subject to a reduction in accordance with Article  
50 28(5)(a) of this Agreement, the Claimant shall be notified in accordance with paragraph (h)  
51 prior to the payment. To the extent that a claim to paid after the end of the relevant  
52 calendar year referred to in paragraph (g) is subject to a reduction in accordance with  
53 Article 28(5)(a) of this Agreement, all payments previously made to the [NCB] or  
54 Connected NCBs with regard to the relevant calendar year referred to in paragraph (g) shall  
55 be recalculated in accordance with Article 28(5)(a) of this Agreement and the paid amounts  
56 shall be adjusted. With regard to this adjustment, the Eurosystem is entitled to claim back  
57 any compensation payment made in excess of the adjusted pro rata entitlement in  
58 accordance with to Article 28(5)(a) of this Agreement.

## 59 2. Procedure in respect of claims pursuant to Article 29(1)

60 The following procedure applies in addition to Article 29(1) if a DCA Holder has caused a Direct  
61 Loss to the Eurosystem in relation to T2S.

62 (a) The Eurosystem shall notify the [NCB] of the fact that an act or omission of one of the  
63 [NCB's] DCA Holders in relation to T2S has caused a Direct Loss to the Eurosystem. The  
64 notification shall be sent by the Eurosystem in writing as soon as reasonably practicable but  
65 in no case later than [90] calendar days after the loss has occurred.

66 (b) The notification shall contain a preliminary indication of the amount and composition of  
67 the claim against the [NCB].

68 (c) A delay shall not relieve the [NCB] of its obligation to reimburse the Eurosystem, except to  
69 the extent that the [NCB] can demonstrate that the delay caused damages.

## Currency Participation Agreement

### Schedule 12 – Procedure for Payment of Claims

---

- 70 (d) The Eurosystem shall precisely set out the amount and the various components of the loss  
71 caused by the DCA Holder and for which it claims reimbursement from the [NCB]. The  
72 [NCB] may request any additional information from the Eurosystem as may be reasonably  
73 required for assessing the merits of the submitted claim. The Eurosystem shall cooperate in  
74 good faith with any such request by the [NCB].
- 75 (e) The [NCB] shall notify the Eurosystem in writing within [90] calendar days from the day  
76 of the receipt of the claim if it accepts the claim or rejects it in whole or in part, in the latter  
77 case giving the reasons for the rejection as set out in paragraph [1] of Article 29. If it  
78 accepts the claim, the [NCB] shall reimburse the Eurosystem within [30] calendar days.
- 79 (f) In case of dispute as to the extent and/or proportion of the Eurosystem's contribution to the  
80 Eurosystem's loss, the Parties shall take recourse to the Dispute Resolution and Escalation  
81 Procedure set out in Article 37 in order to settle the issue in an amicable way.
- 82 (g) As soon as the dispute has been settled, the [NCB] shall reimburse the net amount due to  
83 the Eurosystem within [30] calendar days.
- 84 (h) The Eurosystem shall subrogate the [NCB] to any rights it may have against a DCA Holder  
85 in relation to the reimbursed claim.

# Currency Participation Agreement

## Schedule 12 – Procedure for Payment of Claims

---

### 86 3. Procedure in respect of Article 33(4) (Infringement of IPR)

87 The following procedure applies in addition to Article 33(4) of this Agreement if legal action is  
88 commenced or threatened against the [NCB].

89 (a) If the [NCB] allows the Eurosystem to control the defence against the Third Party claimant,  
90 the Eurosystem shall keep the [NCB] informed in all material matters at all times.  
91 Notwithstanding such agreement regarding the control over the defence, the [NCB], being  
92 the formal party to the legal proceedings, and the Eurosystem shall agree on the way in  
93 which the proceedings are conducted. For this purpose, and in due consideration of the  
94 agreement to give the Eurosystem control over the defence, the [NCB] shall be entitled to  
95 object to legal submissions proposed by the Eurosystem that it considers harmful to the  
96 outcome of such proceedings and to make its own counterproposals towards the  
97 Eurosystem. Expenses of the [NCB] in the context of such involvement shall be borne by  
98 the [NCB].

99 (b) At the request of the Eurosystem the [NCB] shall give all reasonable assistance and provide  
100 all relevant documents and data which are under its control, to the extent permissible under  
101 the applicable statutory and contractual law. The Eurosystem shall indemnify the [NCB]  
102 for all reasonable cost the latter incurred in that context.

103 The following applies in addition to Article 33(4)(b) of this Agreement if the [NCB] is held  
104 legally liable for an infringement.

105 (c) The [NCB] shall notify the Eurosystem of the fact that it is held liable to the Third Party  
106 pursuant to an Enforceable Judgement. The notification shall be sent as soon as reasonably  
107 practicable but in no case later than 30 days after the full text of the court ruling was  
108 available to the [NCB].

109 (d) The notification shall contain a statement to the effect that the [NCB] intends to claim  
110 reimbursement from the Eurosystem, the text of the Enforceable Judgement (to the extent  
111 available) and a preliminary indication of the amount and composition of the claim to  
112 reimbursement.

113 (e) The [NCB] shall submit its claim to the Eurosystem in writing and without undue delay  
114 and in any case no later than 90 calendar days after the full text of the Enforceable  
115 Judgement was made available to the [NCB]. A delay shall not relieve the Eurosystem of  
116 its obligation to reimburse the [NCB], except to the extent that the Eurosystem can  
117 demonstrate that the delay caused damages.

118 (f) The [NCB] shall precisely set out the amount and the various components of the payment it  
119 owes to the Third Party and for which it claims reimbursement from the Eurosystem. The

## Currency Participation Agreement

### Schedule 12 – Procedure for Payment of Claims

---

- 120 Eurosystem may request any additional information from the [NCB] as may be reasonably  
121 required for assessing the merits of the submitted claim. The [NCB] shall cooperate in  
122 good faith with any such request by the Eurosystem.
- 123 (g) The Eurosystem shall notify the [NCB] in writing within 90 calendar days from the day of  
124 the receipt of the claim if it accepts the claim or rejects it in whole or in part, in the latter  
125 case giving reasons for the rejection.
- 126 (h) In case of dispute as to the merits of the reimbursement claim, the Parties shall take  
127 recourse to Article 47 of this Agreement.
- 128 (i) The [NCB] shall subrogate the Eurosystem to any rights it may have against Third Parties  
129 in relation to the reimbursed claim.